

- **Medical Equipment**
- **Surgical instruments**

Gynäkologie

DE	Gynäkologie
EN	Gynecology
ES	Goinecologia
AR	طب امراض النساء

G60

PAGE 001 to 042

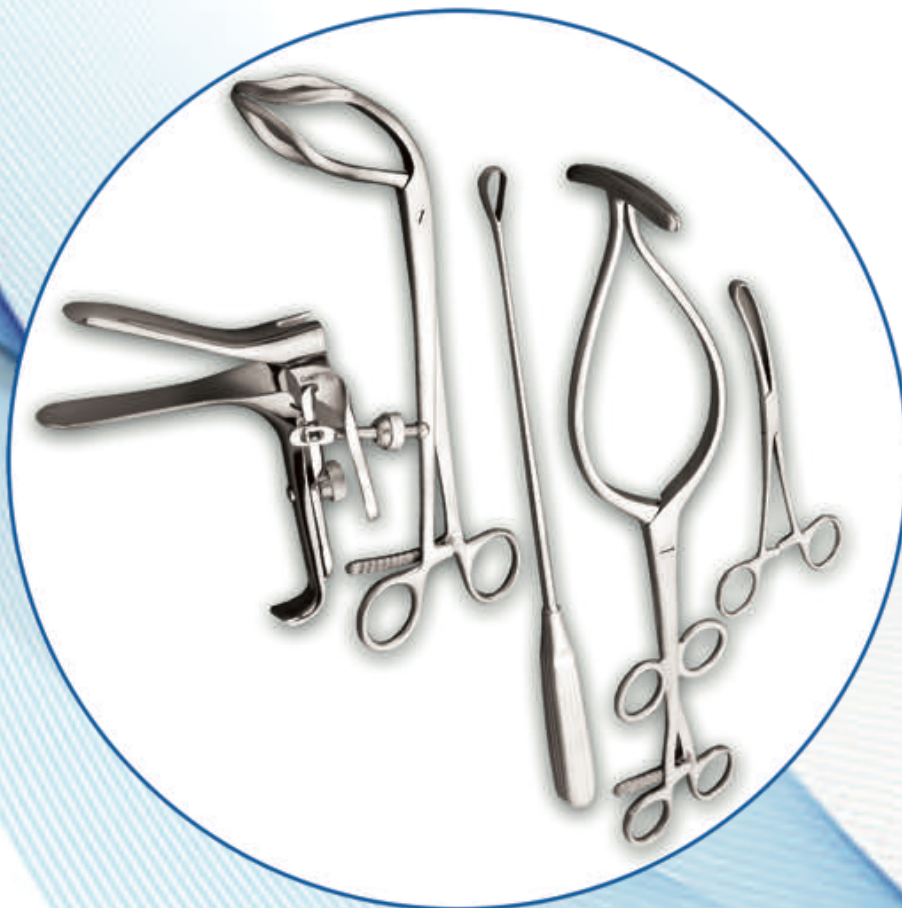

DE Scheidenspekula
EN Vaginal Specula
ES Especulos vaginales
AR مناظير المهبل



CUSCO
G60.0010.01 75 x 17mm
G60.0010.02 75 x 32mm
G60.0010.03 85 x 35mm
G60.0010.04 100 x 37mm

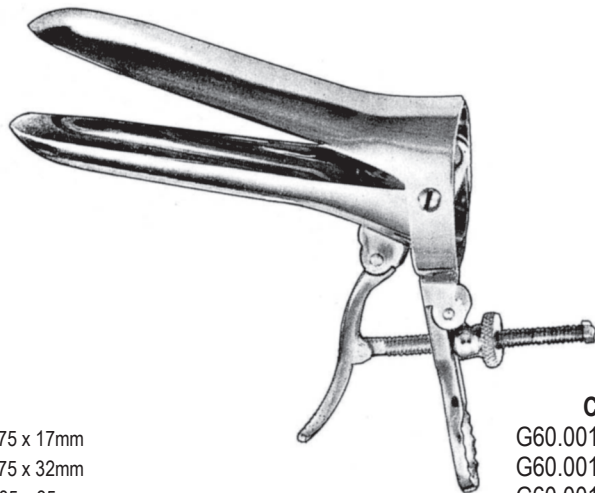

CUSCO
G60.0014.01 75 x 17mm
G60.0014.02 75 x 32mm
G60.0014.03 80 x 32mm
G60.0014.04 85 x 35mm
G60.0014.05 110 x 35mm
G60.0014.06 115 x 37mm



CUSCO
G60.0020.01 75 x 32mm
G60.0020.02 85 x 35mm
G60.0020.03 100 x 35mm
G60.0020.04 85 x 35mm (with cold light carrier)
G60.0020.05 (cold light carrier only)



CUSCO
G60.0022.01 75 x 17mm
G60.0022.02 85 x 17mm
G60.0022.03 100 x 17mm



CUSCO (Swiss pattern)
G60.0024.01 80 x 22mm
G60.0024.02 100 x 25mm
G60.0024.03 105 x 27mm
G60.0024.04 115 x 27mm



CUSCO'S
G60.0026.01 (LL)
G60.0026.02 (L)
G60.0026.03 (M)
G60.0026.04 (S)
G60.0026.05 (SS)
G60.0026.06 (SSS)

G60.0026.06 **G60-001**



G60

Scheidenspekula DE

Vaginal Specula EN

Especulos vaginales ES

مناظير المهبل AR



PEDERSON

- G60.0030.01 75 x 13mm
- G60.0030.02 100 x 22mm
- G60.0030.03 120 x 25mm
- G60.0030.04 130 x 25mm



GRAVE

- G60.0034.01 75 x 20mm
- G60.0034.02 95 x 35mm
- G60.0034.03 115 x 35mm
- G60.0034.04 125 x 35mm



SEMM

- G60.0040.01 100 x 17/20mm
- G60.0040.02 100 x 25/30mm



FERGUSON

- G60.0050.01 25mm Ø
- G60.0050.02 30mm Ø
- G60.0050.03 35mm Ø
- G60.0050.04 40mm Ø

G60-002 G60.0050.04

DE Scheidenspekula
EN Vaginal Specula
ES Especulos vaginales
AR مناظير المهبل

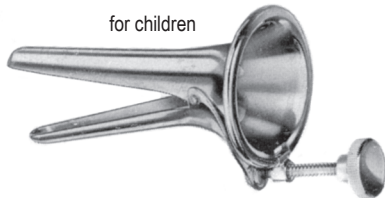

COLLIN
G60.0054.01 55 x 10mm



COLLIN
G60.0060.01 65 x 20mm



COLLIN-LANDAU
G60.0064.01 100 x 35mm



COLLIN
G60.0066.01 85 x 30mm
G60.0066.02 100 x 35mm
G60.0066.03 110 x 40mm
G60.0066.04 100 x 35mm (with cold light carrier)
G60.0066.05 (cold light carrier only)

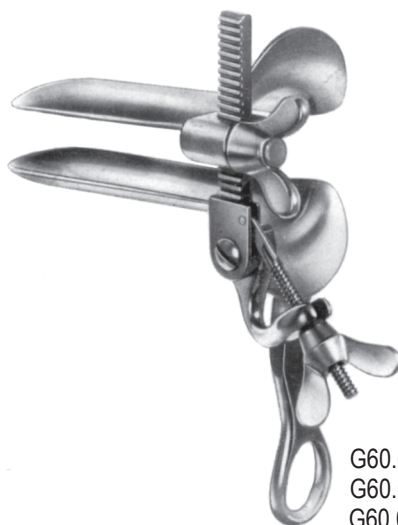

TRELAT
G60.0068.01 85 x 33mm
G60.0068.02 95 x 35mm
G60.0068.03 115 x 43mm



SAKURAI'S
G60.0070.01 (LL)
G60.0070.02 (L)
G60.0070.03 (M)
G60.0070.04 (S)



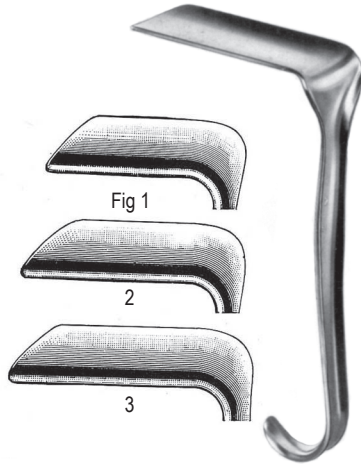

JACKSON

- G60.0080.01 75 x 35mm
- G60.0080.02 90 x 35mm
- G60.0080.03 100 x 35mm
- G60.0080.04 75 x 40mm
- G60.0080.05 90 x 40mm
- G60.0080.06 100 x 40mm

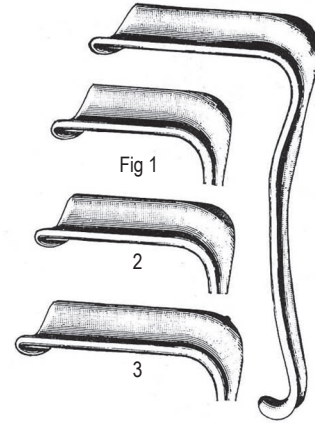

EASTMANN

- G60.0084.01 75 x 35mm
- G60.0084.02 90 x 35mm
- G60.0084.03 100 x 35mm
- G60.0084.04 75 x 40mm
- G60.0084.05 90 x 40mm
- G60.0084.06 100 x 40mm



SIMS

- G60.0090.01 65 x 25, 70 x 30mm
- G60.0090.02 70 x 30, 70 x 35mm
- G60.0090.03 85 x 35, 90 x 40mm
- G60.0090.04 100 x 35 x 40mm
- G60.0090.05 120 x 35 x 40mm

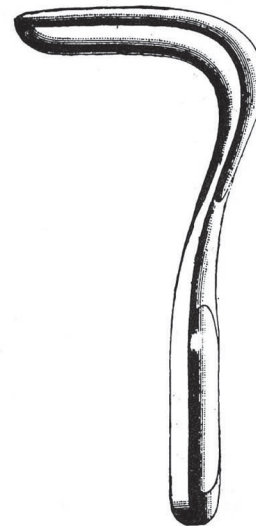

SIMS

- G60.0094.01 60 x 25mm
- G60.0094.02 70 x 30mm
- G60.0094.03 80 x 35mm



- DE Scheidenspekula und halter
- EN Vaginal specula and Retractors
- ES Especulas y valvas vaginales
- AR مناظير المهبل والكامشات



56 x 13mm

BRAUN
G60.0100.18 18.0cm



60 x 10mm

BRAUN
G60.0102.18 18.0cm

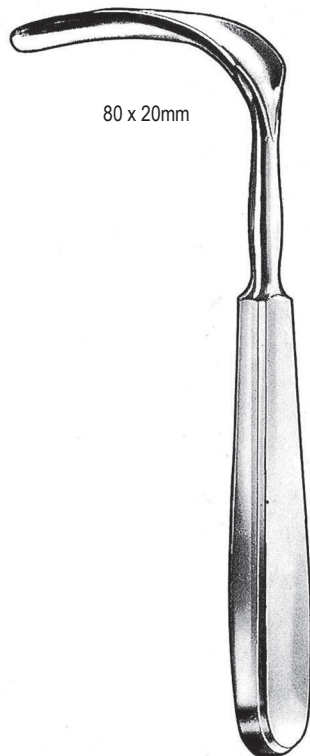

80 x 20mm

ULRICH
G60.0110.19 19.5cm

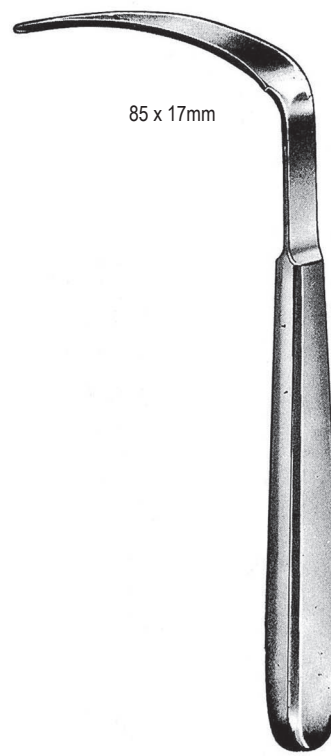

85 x 17mm

G60.0112.19 19.0cm

G60.0112.19 **G60-005**



G60

Scheidenspekula und halter DE
Vaginal Specula and Retractors EN
Especulos y valvas vaginales ES
مناظير المهبل والكامشات AR



KRISTELLER
specula

Fig 1. G60.0120.01 110 x 18mm
Fig 2. G60.0120.02 110 x 21mm



KRISTELLER
retractors

Fig 1. G60.0122.01 115 x 14mm
Fig 2. G60.0122.02 115 x 17mm



KRISTELLER

set of 1 speculum and 1 retractor each
Fig 1. G60.0124.00
Fig 2. G60.0126.00



KRISTELLER
specula

Fig.1 G60.0130.01 70 x 27mm
Fig.2 G60.0130.02 80 x 30mm
Fig.3 G60.0130.03 90 x 36mm



KRISTELLER
retractors

Fig.1 G60.0132.01 75 x 23mm
Fig.2 G60.0132.02 85 x 26mm
Fig.3 G60.0132.03 100 x 32mm



KRISTELLER

set of 1 speculum and 1 retractors each
Fig.1 G60.0134.00
Fig.2 G60.0136.00
Fig.3 G60.0138.00

G60-006 G60.0138.00



DE Scheidenspekula und halter
 EN Vaginal specula and Retractors
 ES Especulas y valvas vaginales
 AR مناظير المهبل والكامشات



KRISTELLER
specula

G60.0140.01 110 x 27mm
 G60.0140.02 110 x 30mm
 G60.0140.03 110 x 36mm



KRISTELLER
retractors

G60.0142.01 115 x 23mm
 G60.0142.02 115 x 26mm
 G60.0142.03 115 x 32mm



KRISTELLER
set of 1 speculum and 1 retractor each

G60.0144.00
 G60.0146.00
 G60.0148.00



KRISTELLER
specula

Fig.1 G60.0150.01 105 x 26mm
 Fig.2 G60.0150.02 105 x 28mm
 Fig.3 G60.0150.03 105 x 33mm



KRISTELLER
retractors

Fig.1 G60.0152.01 115 x 22mm
 Fig.2 G60.0152.02 115 x 24mm
 Fig.3 G60.0152.03 115 x 29mm



KRISTELLER
set of 1 speculum and 1 retractors each

Fig.1 G60.0154.00
 Fig.2 G60.0156.00
 Fig.3 G60.0158.00



G60

Scheidenspekula und halter **DE**
 Vaginal Specula and Retractors **EN**
 Especulos y valvas vaginales **ES**
 مناظير المهبل والكامشات **AR**

extra large pattern



G60.0160.01
140 x 30mm



G60.0162.01
135 x 36mm



G60.0164.01
135 x 36mm



vaginal specula



vaginal retractors

KALLMORGEN

- G60.0170.01 70 x 40mm
- G60.0170.02 90 x 40mm
- set
- G60.0174.00
- G60.0176.00

- G60.0172.01 70 x 33mm
- G60.0172.02 90 x 33mm



vaginal specula



vaginal retractors

MATHIEU

- G60.0180.01 95 x 16mm
- G60.0180.02 95 x 26mm
- G60.0180.02 95 x 26mm
- G60.0180.02 95 x 30mm
- set
- G60.0184.00
- G60.0186.00
- G60.0182.01 100 x 11mm
- G60.0182.01 100 x 20mm
- G60.0182.02 100 x 14mm
- G60.0182.02 100 x 26mm

G60-008 G60.0186.00



DE Scheidenspekula
EN Vaginal Specula
ES Especulos vaginales
AR مناظير المهبل



DOYEN FG DOYEN

Fig	mm	mm	slightly-concave	slightly-concave	medium-concave
1	55	35	G60.0190.01	G60.0200.01	G60.0210.01
2	85	35	G60.0190.02	G60.0200.02	G60.0210.02
3	115	35	G60.0190.03	G60.0200.03	G60.0210.03
1	55	45	G60.0192.01	G60.0202.01	G60.0212.01
2	85	45	G60.0192.02	G60.0202.02	G60.0212.02
3	115	45	G60.0192.03	G60.0202.03	G60.0212.03
1	55	60	G60.0194.01	G60.0204.01	G60.0214.01
2	85	60	G60.0194.02	G60.0204.02	G60.0214.02
3	115	60	G60.0194.03	G60.0204.03	G60.0214.03

DOYEN

G60.0220.01 75 x 45mm
G60.0220.02 90 x 45mm
G60.0220.03 110 x 45mm

G60.0220.03 **G60-009**

G60

Scheidenspekula DE

Vaginal Specula EN

Especulos vaginales ES

مناظير المهبل AR

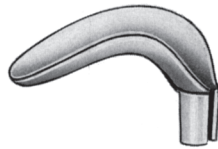

G60.0230.01

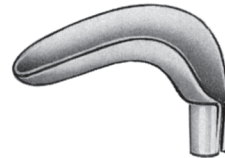

G60.0230.02

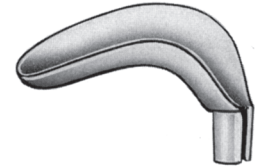

G60.0230.03

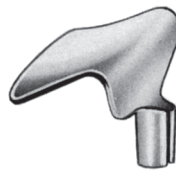

G60.0230.04

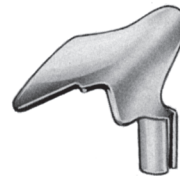

G60.0230.05

G60.0230.40
weight, light, 400gm
G60.0230.80
weight, heavy, 800gm

SCHERBAK

G60.0230.00 set complete
G60.0230.10 handle only



A
G60.0242.10
handle only



70 x 30mm
G60.0244.01



80 x 35mm
G60.0244.02



90 x 35mm
G60.0244.03



100 x 35mm
G60.0244.04



80 x 30mm
G60.0244.05



85 x 33mm
G60.0244.06



100 x 35mm
G60.0244.07



110 x 42mm
G60.0244.08

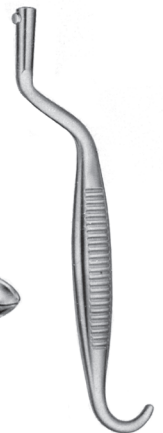

B
G60.0244.10
handle only

BOZEMANN

G60.0240.00 compl. set with handle A, B and 8 blades
G60.0242.00 compl. set with handle A and 8 blades
G60.0244.00 compl. set with handle B and 8 blades

G60-010 G60.0244.10



DE Scheidenspekula
 EN Vaginal Specula
 ES Especulos vaginales
 AR مناظير المهبل

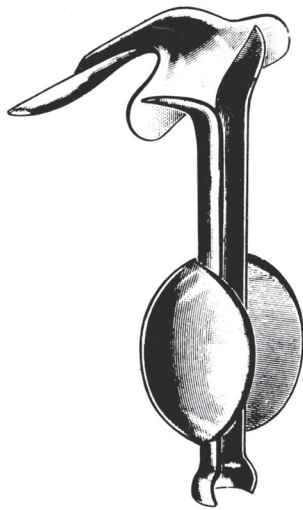

AUVARD

G60.0250.01 80 x 38mm 2 lbs
 G60.0250.02 80 x 38mm 2.5 lbs
 G60.0250.03 80 x 38mm 3 lbs

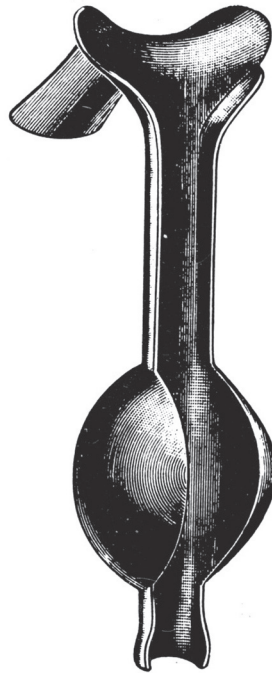

AUVARD

G60.0254.00 68 x 40mm 3 lbs



AUVARD

G60.0260.01 2.5 lbs
 G60.0260.02 3 lbs

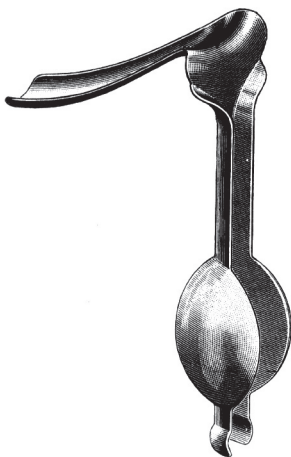

STEINER-AUVARD

G60.0264.01 140 x 35mm 2.5 lbs
 G60.0266.01 140 x 35mm 2.5 lbs
 laser pattern

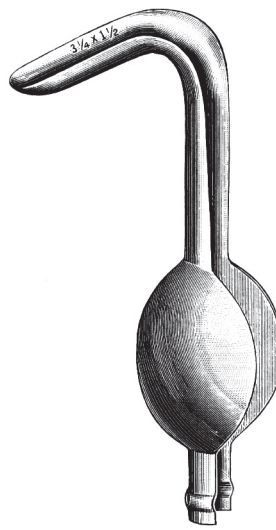

HENROTIN

G60.0270.01 80 x 35mm 3 lbs
 30° blade angled down

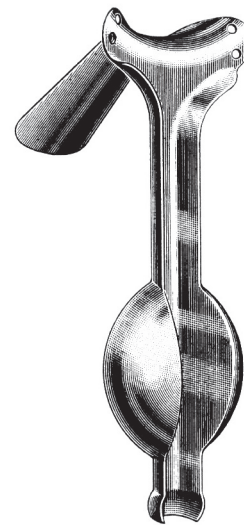

BERLIND-AUVARD

G60.0274.01 105 x 40mm 2.5 lbs

G60.0274.01 **G60-011**



G60

Scheidenspekula und halter **DE**
Vaginal Specula and Retractors **EN**
Especulos y valvas vaginales **ES**
مناظير المهبل والكامشات **AR**



LANDAU

G60.0300.01 105 x 28mm
G60.0300.02 105 x 38mm



BREISKY

G60.0304.01 100 x 20mm
G60.0304.02 100 x 25mm
G60.0304.03 100 x 30mm
G60.0304.04 100 x 35mm
G60.0304.05 100 x 40mm

G60.0306.01 130 x 20mm
G60.0306.02 130 x 25mm
G60.0306.03 130 x 30mm
G60.0306.04 130 x 35mm
G60.0306.05 130 x 40mm

G60.0308.01 155 x 40mm



DUNKEL

G60.0310.22

G60-012 G60.0310.22



- DE Scheidenspekulum,-halter, Wundspreizer
- EN Vaginal Specula, Retractors
- ES Especulos y valvas vaginales, Separadores
- AR مناظير المهبل والكامشات



O'SULLIVAN-O'CONNOR
G60.0314.00 set complete



G60.0314.01 Fig. 1 = 45 x 17mm
G60.0314.02 Fig. 2 = 90 x 37mm
G60.0314.03 Fig. 3 = 90 x 45mm



DOYEN
G60.0320.24 24.0cm





FRIEDMAN
G60.0324.10 10.0cm

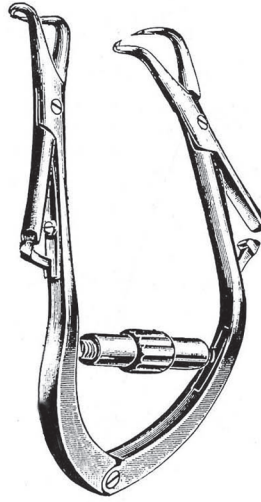

JOLL
G60.0330.15 15.0cm

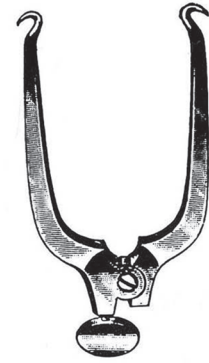

COMYNS-BERKELEY
G60.0334.00

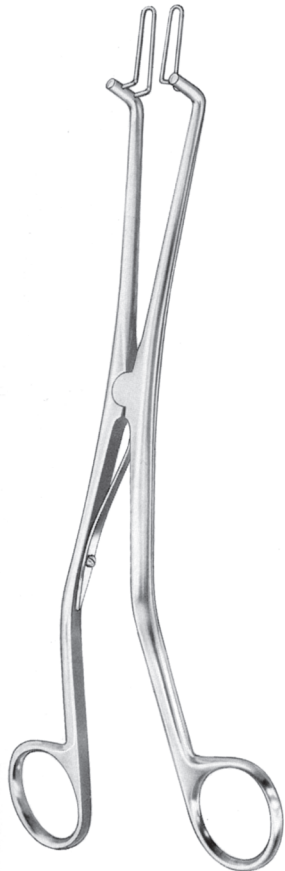

KOGAN
24.0cm
G60.0340.24 2/4mm
G60.0340.48 4/8mm

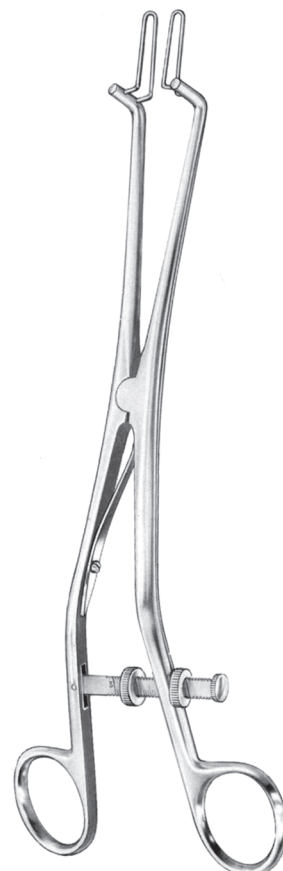

KOGAN
24.0cm laser
G60.0344.24 2/4mm G60.0346.24
G60.0344.48 4/8mm G60.0346.48



DE Uterus-Dilatatoren
EN Uterine Dilators
ES Dilatadores uterinos
AR الموسعات الرحم



HEGAR

G60.0350.01 - G60.0350.30
(1.0mm - 30.0mm)

	mm dia.		mm dia.
G60.0350.01	1.0	G60.0351.01	1.5
G60.0350.02	2.0	G60.0351.02	2.5
G60.0350.03	3.0	G60.0351.03	3.5
G60.0350.04	4.0	G60.0351.04	4.5
G60.0350.05	5.0	G60.0351.05	5.5
G60.0350.06	6.0	G60.0351.06	6.5
G60.0350.07	7.0	G60.0351.07	7.5
G60.0350.08	8.0	G60.0351.08	8.5
G60.0350.09	9.0	G60.0351.09	9.5
G60.0350.10	10.0	G60.0351.10	10.5
G60.0350.11	11.0	G60.0351.11	11.5
G60.0350.12	12.0	G60.0351.12	12.5
G60.0350.13	13.0	G60.0351.13	13.5
G60.0350.14	14.0	G60.0351.14	14.5
G60.0350.15	15.0	G60.0351.15	15.5
G60.0350.16	16.0	G60.0351.16	16.5
G60.0350.17	17.0	G60.0351.17	17.5
G60.0350.18	18.0	G60.0351.18	18.5
G60.0350.19	19.0	G60.0351.19	19.5
G60.0350.20	20.0	G60.0351.20	20.5
G60.0350.21	21.0	G60.0351.21	21.5
G60.0350.22	22.0	G60.0351.22	22.5
G60.0350.23	23.0	G60.0351.23	23.5
G60.0350.24	24.0	G60.0351.24	24.5
G60.0350.25	25.0	G60.0351.25	25.5
G60.0350.26	26.0	G60.0351.26	26.5
G60.0350.27	27.0	G60.0351.27	27.5
G60.0350.28	28.0	G60.0351.28	28.5
G60.0350.29	29.0	G60.0351.29	29.5
G60.0350.30	30.0	G60.0351.30	30.5

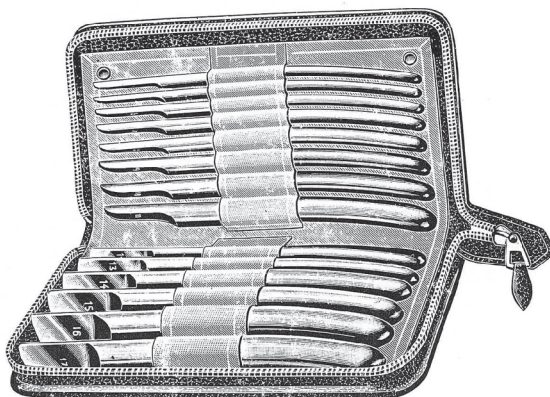

HEGAR

G60.0350.00 (4 to 17 mm dia)
set of 14

G60.0352.00 (1 to 26 mm dia)
set of 26

G60.0354.00 (1 to 30 mm dia)
set of 30



HEGAR

G60.0360.00 (4 to 17 mm dia)
set of 14

G60.0362.00 (1 to 26 mm dia)
set of 26

G60.0364.00 (1 to 30 mm dia)
set of 30

G60.0364.00 **G60-015**



G60

Uterus-Dilatatoren DE

Uterine Dilators EN

Dilatadores uterinos ES

الموسعات الرحم AR



HEGAR

G60.0370.01 - G60.0370.25
(1/2 - 25/26 mm dia.)

mm dia.

G60.0370.01	1/2
G60.0370.03	3/4
G60.0370.05	5/6
G60.0370.07	7/8
G60.0370.09	9/10
G60.0370.11	11/12
G60.0370.13	13/14
G60.0370.15	15/16
G60.0370.17	17/18
G60.0370.19	19/20
G60.0370.21	21/22
G60.0370.23	23/24
G60.0370.25	25/26

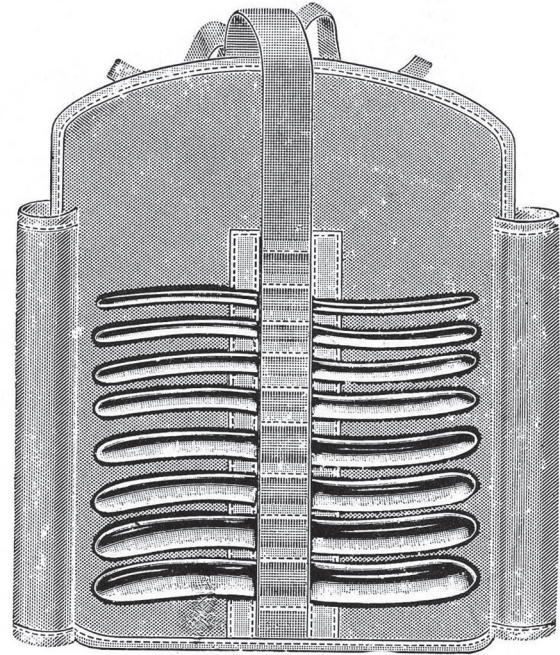

HEGAR

G60.0370.00	G60.0372.00
set of 8	set of 13
(3/4 to 17/18 mm dia)	(1/2 to 25/26 mm dia)

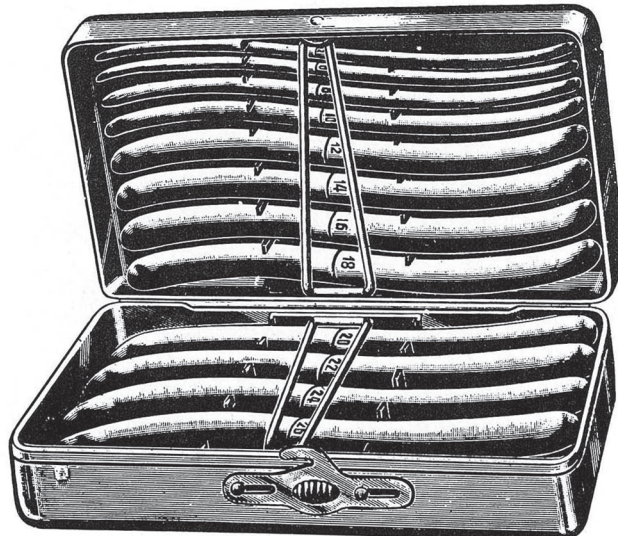

HEGAR

G60.0380.00	G60.0382.00
set of 8	set of 13
(3/4 to 17/18 mm dia)	(1/2 to 25/26 mm dia)

G60-016 G60.0382.00

DE Uterus-Dilatatoren
EN Uterine Dilators
ES Dilataores uterinos
AR الموسعات الرحم

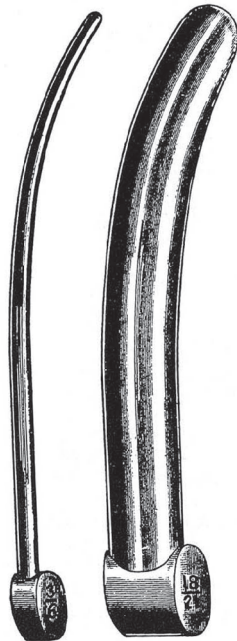

	mm dia.
G60.0390.01	3/6
G60.0390.02	4/7
G60.0390.03	5/8
G60.0390.04	6/9
G60.0390.05	7/10
G60.0390.06	8/11
G60.0390.07	9/12
G60.0390.08	10/13
G60.0390.09	11/14
G60.0390.10	12/15
G60.0390.11	13/16
G60.0390.12	14/17
G60.0390.13	15/18
G60.0390.14	16/19
G60.0390.15	17/20
G60.0390.16	18/21

HAWKINS-AMBLER
G60.0390.00 set of 12
G60.0392.00 set of 16

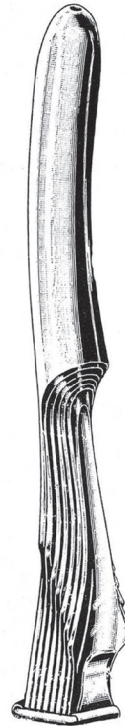

G60.0400.01	3-7 mm dia
G60.0400.02	5-9 mm dia
G60.0400.03	7-12 mm dia
G60.0400.04	9-15 mm dia
G60.0400.05	12-18 mm dia

JOLLY
G60.0400.00 set of 5



HANK
G60.0404.00 set

Fig.9/10	G60.0404.01	4,5/5 mm
Fig.11/12	G60.0404.02	5,5/6 mm
Fig.13/14	G60.0404.03	6,5/7 mm
Fig.15/16	G60.0404.04	7,5/8 mm
Fig.17/18	G60.0404.05	8,5/9 mm
Fig.19/20	G60.0404.06	9,5/10 mm

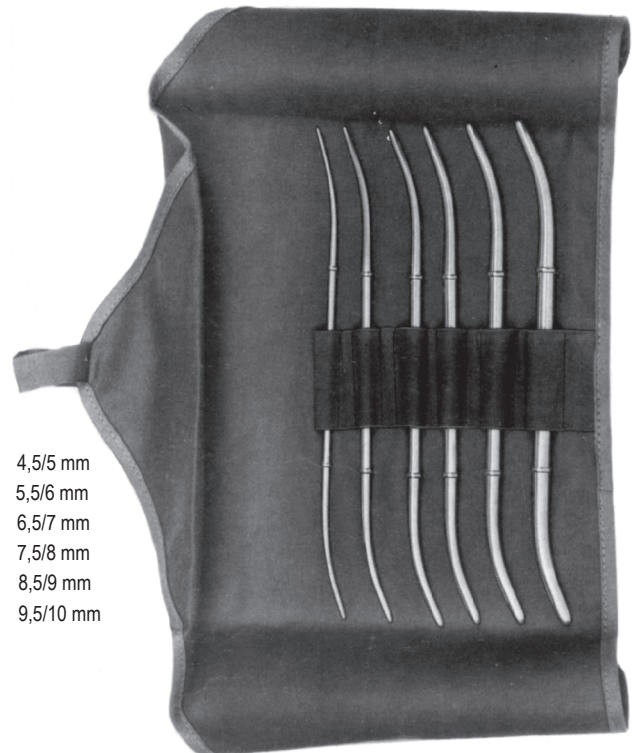

HANK
G60.0406.00 set

G60.0406.00 **G60-017**





mm	
1	G60.0410.01
2	G60.0410.02
3	G60.0410.03
4	G60.0410.04
5	G60.0410.05
6	G60.0410.06
7	G60.0410.07
8	G60.0410.08
9	G60.0410.09
10	G60.0410.10
11	G60.0410.11
12	G60.0410.12
13	G60.0410.13
14	G60.0410.14
15	G60.0410.15
16	G60.0410.16
17	G60.0410.17
18	G60.0410.18
19	G60.0410.19
20	G60.0410.20



HEGAR set

- G60.0410.00 1 to 13mm
- G60.0412.00 1 to 20mm
- G60.0414.00 14 to 20mm

- DE Uterus-Dilatatoren
- EN Uterine Dilators
- ES Dilataores uterinos
- AR الموسعات الرحم

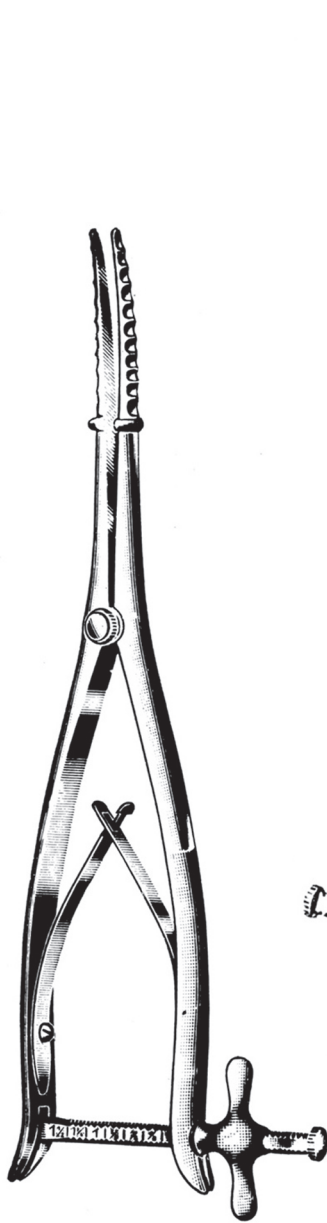

WYLIE
G60.0420.29 serrated
G60.0422.29 smooth
29.0cm

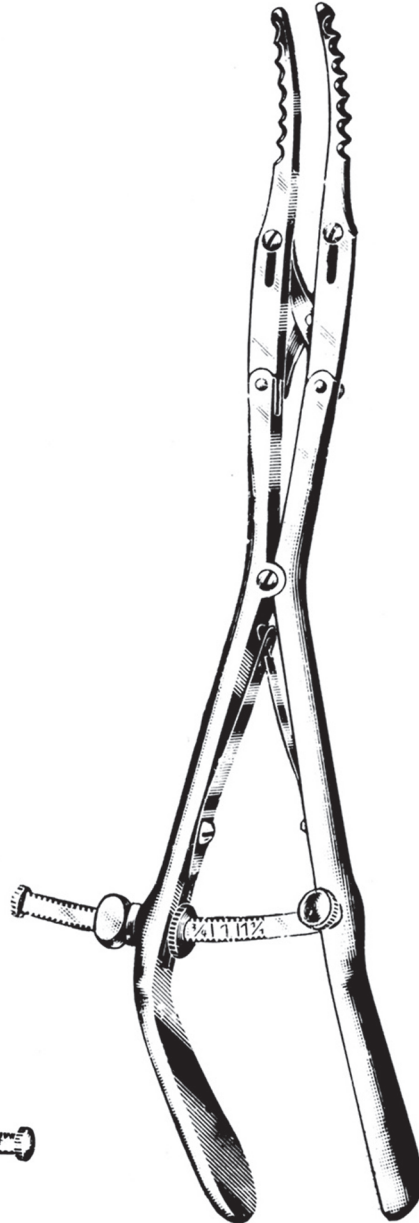

GOODELL
G60.0426.34 34.0cm

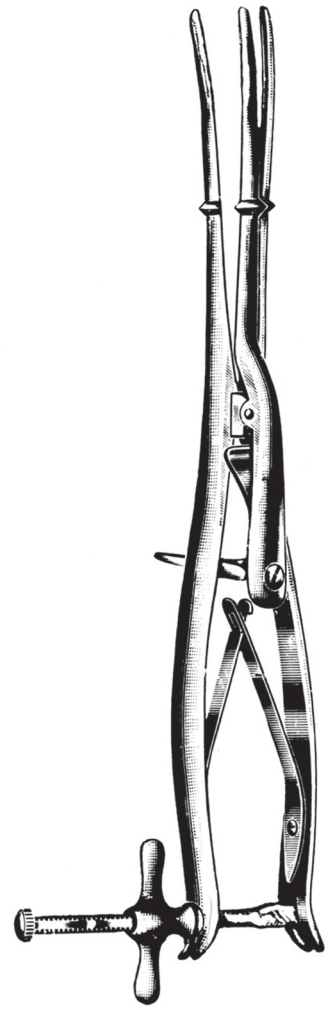

SIMS
G60.0430.29 29.0cm



Uterusdepressoren, Tamponstopfer und Schwammhalter **DE**

Uterine Depressors, Gauze Packer and Sponge Holder **EN**

Depresores uterinos, Porta-tapones y esponjas **ES**

خافض الرحم، مدك الشاش وممسك الإسفنج **AR**



BRAUN
G60.0440.28 28.0cm



SIMS
G60.0444.26 26.0cm



FANO
G60.0450.22 22.0cm

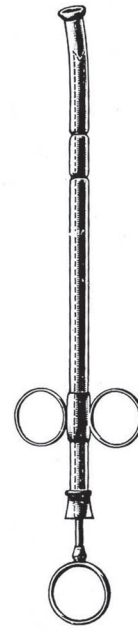

RAPID
G60.0454.01 200 x 8mm
G60.0454.02 250 x 10mm
G60.0454.03 250 x 12mm



SIMS
G60.0460.27 27.0cm

G60-020 G60.0460.27



DE Uterussonden
 EN Uterine Sounds
 ES Histerometros
 AR مسبار الرحمي

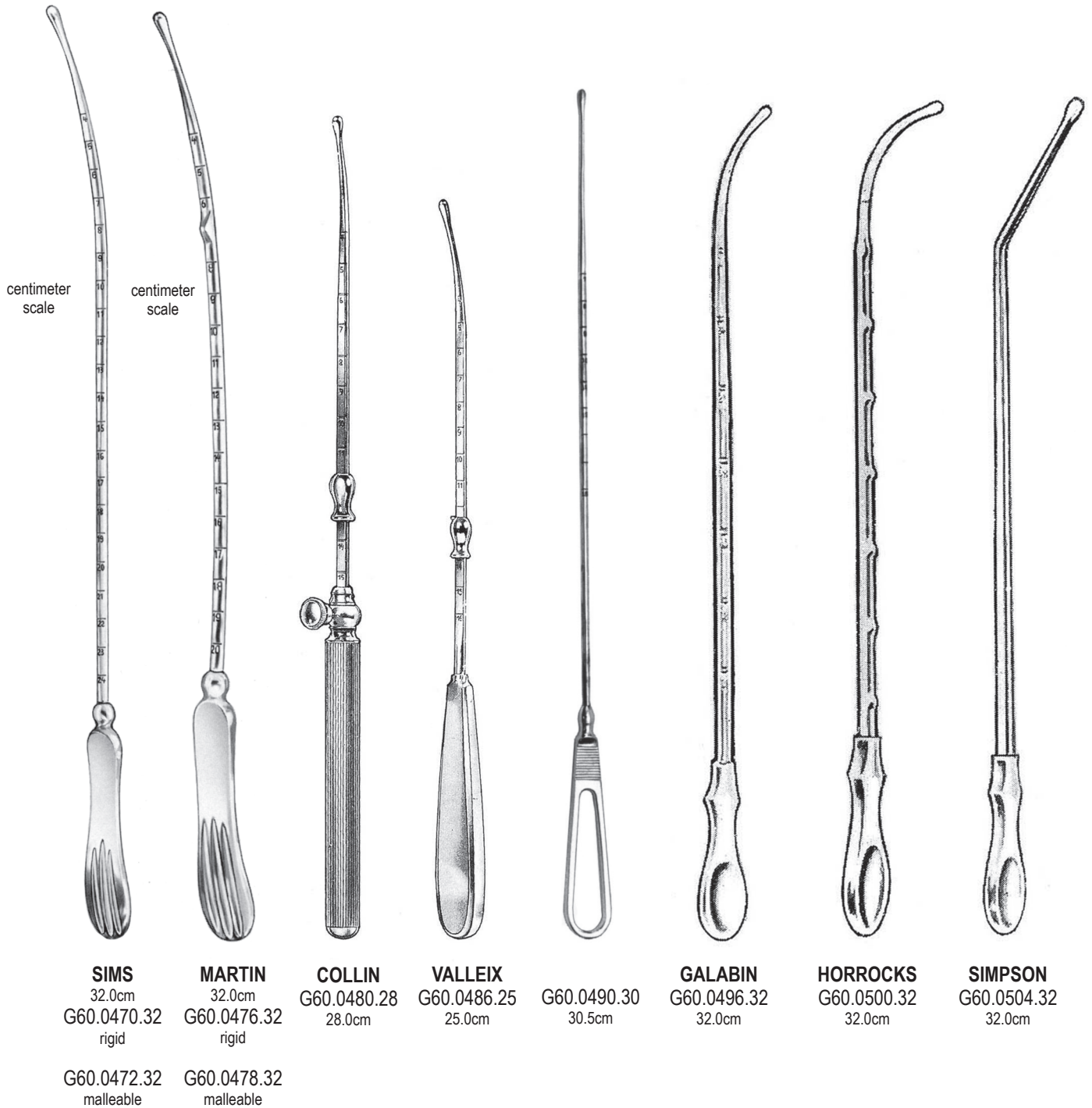

SIMS
32.0cm
G60.0470.32
rigid

MARTIN
32.0cm
G60.0476.32
rigid

COLLIN
G60.0480.28
28.0cm

VALLEIX
G60.0486.25
25.0cm

G60.0490.30
30.5cm

GALABIN
G60.0496.32
32.0cm

HORROCKS
G60.0500.32
32.0cm

SIMPSON
G60.0504.32
32.0cm

G60.0472.32
malleable

G60.0478.32
malleable

G60.0504.32 **G60-021**



G60

Myom-Instrumente DE
Myoma Instruments EN
Instrumentos para fibroma ES
أدوات ورم عضلي AR



DOYEN

17.0cm

G60.0510.01 T-handle
G60.0510.02 loop handle



DOYEN

17.0cm

G60.0512.01 T-handle
G60.0512.02 loop handle



SEGOND

G60.0516.27 27.0cm

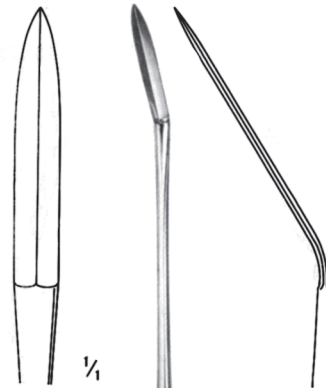

AYRE

G60.0520.23 23.0cm

G60-022 G60.0520.23



DE **Fistelhaken**
EN **Fistula Hooks**
ES **Ganchos p/fistulas**
AR **خطاطيف الناسور**



EMMET
22.0cm



G60.0526.24 24.0cm



SIMON
G60.0530.22 22.0cm



SIMON
G60.0532.22 22.0cm

G60.0532.22 **G60-023**



Hakenzangen DE

Tenaculum Forceps EN

Pinzas para coger el cuello del utero ES

الملقط الخطافي AR



POZZI
G60.0540.25 25.0cm



POZZI
G60.0542.25 25.0cm

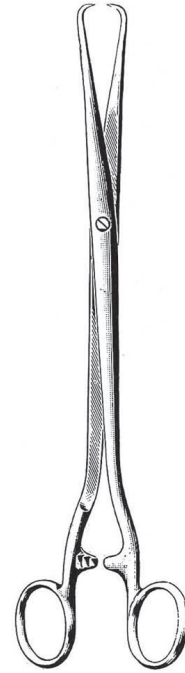

SCHROEDER
G60.0546.25 25.0cm



STAUDE-MOORE
G60.0550.17 17.0cm
strong pattern

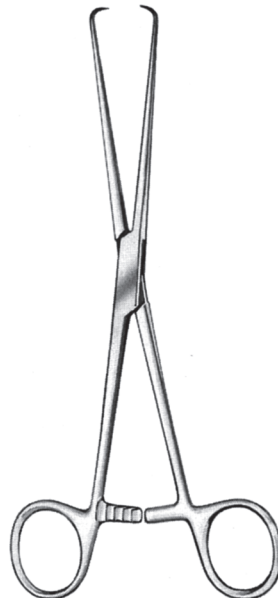

BARRETT
G60.0554.18 18.0cm

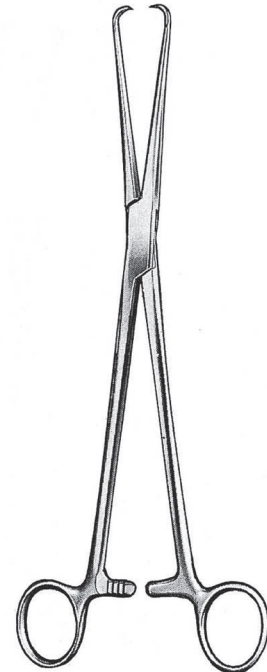

POZZI
G60.0560.25 25.5cm

G60-024 G60.0560.25



DE Hakenzangen

EN Tenaculum Forceps

ES Pinzas para coger el cuello del utero

AR الملقط الخطافي

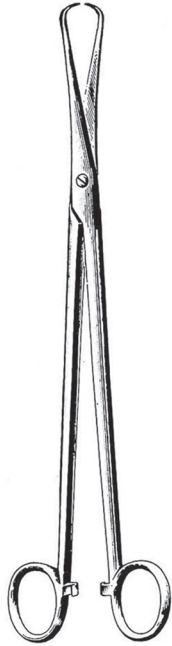

MARTIN
G60.0564.27 27.0cm



SKENE
G60.0570.24 24.0cm

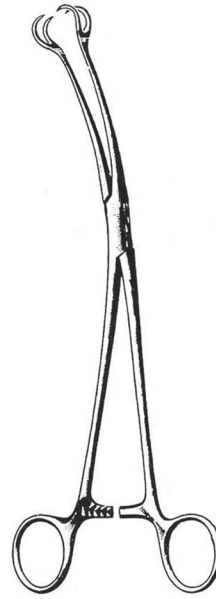

SKENE
G60.0574.23 23.0cm



ABEL
G60.0576.27 27.0cm



SCHROEDER
G60.0580.25 25.0cm



BRAUN
G60.0584.25 25.0cm



DUPLAY
G60.0590.28 28.0cm



BEACHAM
G60.0594.26 26.0cm

G60.0594.26 **G60-025**



Hakenzangen DE

Tenaculum Forceps EN

Pinzas para coger el cuello del utero ES

الملقط الخطافي AR

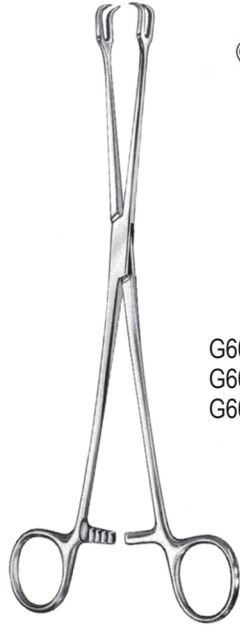

SCHROEDER

- G60.0600.23 23.0cm
- G60.0600.24 24.0cm
- G60.0600.26 26.0cm



- G60.0601.23 23.0cm
- G60.0601.24 24.0cm
- G60.0601.26 26.0cm



- G60.0603.23
- G60.0603.24
- G60.0603.26

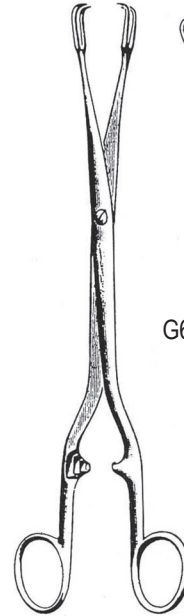

SCHROEDER

- G60.0606.26 26.0cm



- G60.0607.26 26.0cm



TEALE

- G60.0610.18 18.0cm
- G60.0610.23 23.0cm



TEALE

- G60.0614.18 18.0cm
- G60.0614.23 23.0cm
- G60.0614.25 25.0cm



IOWA

- G60.0620.26 26.0cm

G60-026 G60.0620.26

DE Hakenzangen

EN Tenaculum Forceps

ES Pinzas para coger el cuello del utero

AR الملقط الخطافي

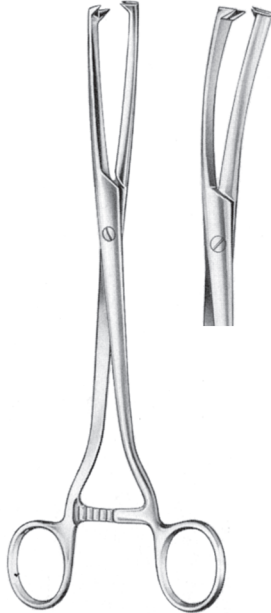

MUSEUX

straight	24.0cm	curved sideway
G60.0630.06	6mm	G60.0631.06
G60.0630.08	8mm	G60.0631.08
G60.0630.10	10mm	G60.0631.10

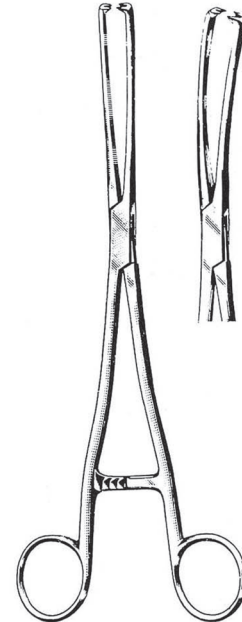

MUSEUX

straight	24.0cm	curved sideway
G60.0634.06	6mm	G60.0635.06
G60.0634.08	8mm	G60.0635.08
G60.0634.10	10mm	G60.0635.10

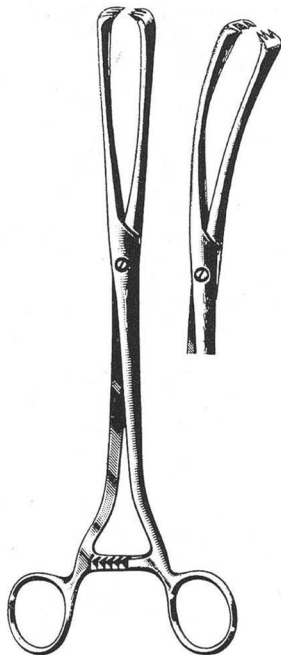

MUSEUX

straight	26.0cm	curved sideway
G60.0638.09	9mm	G60.0639.09
G60.0638.11	11mm	G60.0639.11
G60.0638.13	13mm	G60.0639.13

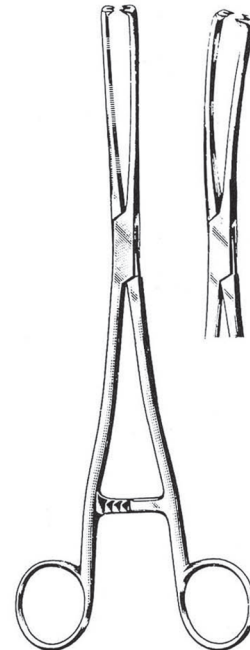

MUSEUX

straight	26.0cm	curved sideway
G60.0642.09	9mm	G60.0643.09
G60.0642.11	11mm	G60.0643.11
G60.0642.13	13mm	G60.0643.13

G60.0643.13 **G60-027**



Hakenzangen DE

Tenaculum Forceps EN

Pinzas para coger el cuello del utero ES

الملقط الخطافي AR



JACOBS
G60.0646.21 21.0cm G60.0647.21



HENROTIN
G60.0650.20 20.0cm



BRAUN
G60.0654.15 15.5cm



CZERNY
G60.0660.20 20.5cm



G60.0664.26 26.0cm

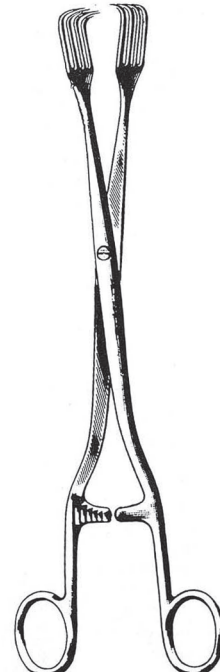

PRATT
G60.0668.28 28.0cm

G60-028 G60.0668.28



DE **Hysterektomieklemmen**
EN **Hysterectomy Forceps**
ES **Pinzas-clamps p/histerectomia**
AR **الملقط استئصال الرحم**

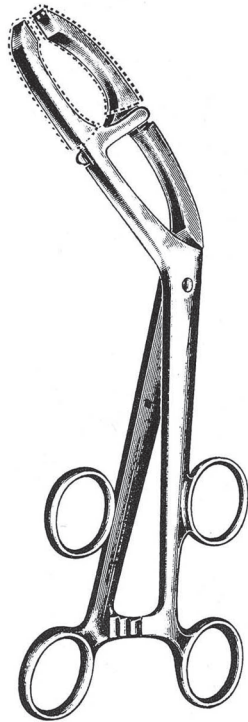

BONNEY
G60.0672.27 27.0cm

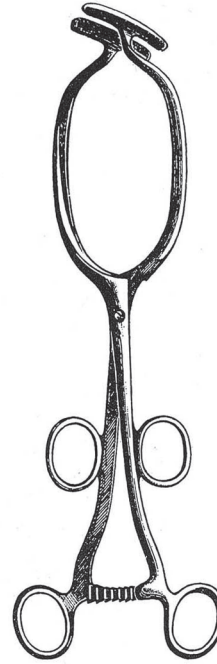

BONNEY
G60.0674.27 27.0cm

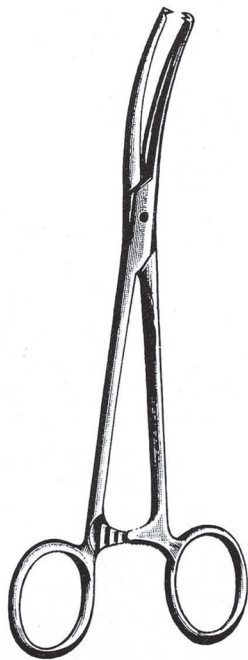

MAINGOT
G60.0676.20 20.0cm G60.0677.20
G60.0676.24 24.0cm G60.0677.24



GWILLIAM
G60.0678.20 20.0cm G60.0679.20

G60.0679.20 **G60-029**



Uterus Polypen und Fasszangen DE

Uterine Polypus and Elevating Forceps EN

Pinzas para polpos el uterinos ES

الملقط سائلة الرحم وإعلاء AR



KELLY
G60.0684.32 32.0cm

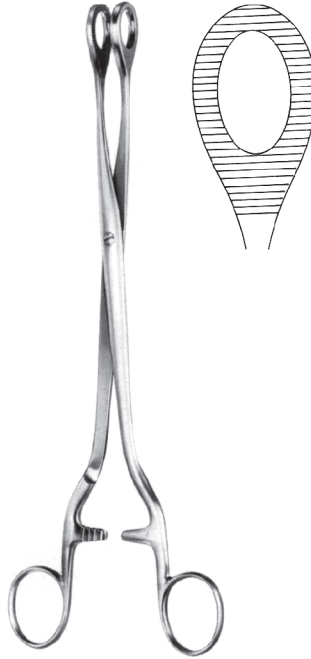

NOTO
G60.0690.27 27.0cm

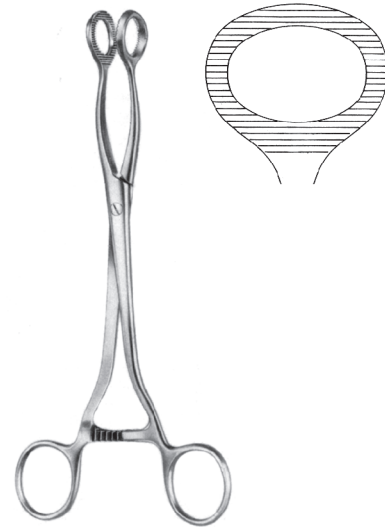

DOYEN
G60.0694.20 20.0cm



DARTIGUES
G60.0700.27 27.0cm



SOMER
G60.0704.23 23.0cm

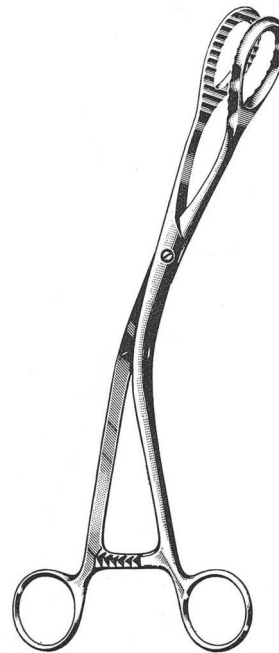

PRUESMANN
G60.0710.27 27.5cm



COLLIN
G60.0714.25 25.0cm

G60-030 G60.0714.25



DE Probeexzisionszangen
EN Cervical Biopsy and Specimen Forceps
ES Pinzas saca-bocados para biopsia
AR الملقط خزعة عنق الرحم ونموذج



THOMS-GAYLOR
G60.0750.24 24.0cm



THOMS-GAYLOR
G60.0754.22 22.0cm
G60.0754.24 24.0cm

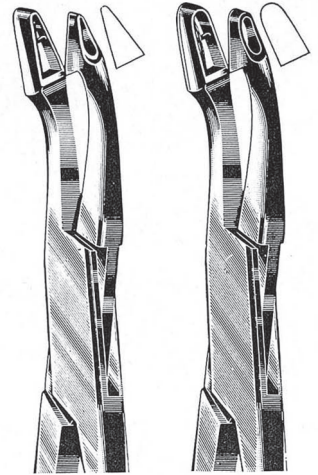

G60.0760.01 G60.0760.02

VAN DOREN
24.0cm



GELLHORN
G60.0764.23 23.0cm



FAURE
G60.0770.21 21.0cm



SCHUBERT
G60.0774.26 26.0cm



SCHUBERT
G60.0778.21 21.0cm
G60.0778.29 29.0cm

G60.0778.29 **G60-031**



G60

Probeexzisionszangen DE
Cervical Biopsy and Specimen Forceps EN
Pinzas saca-bocados para biopsia ES
الملقط خزعة عنق الرحم ونموذج AR

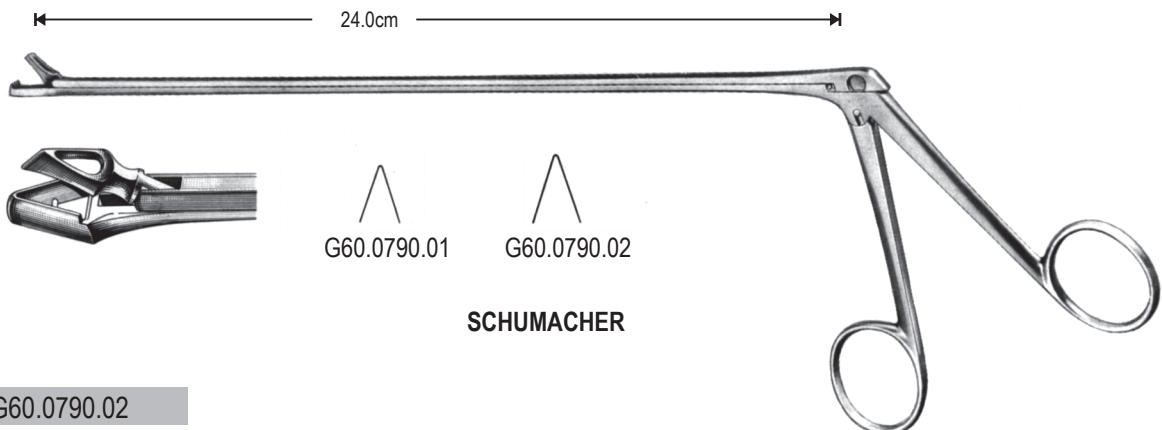
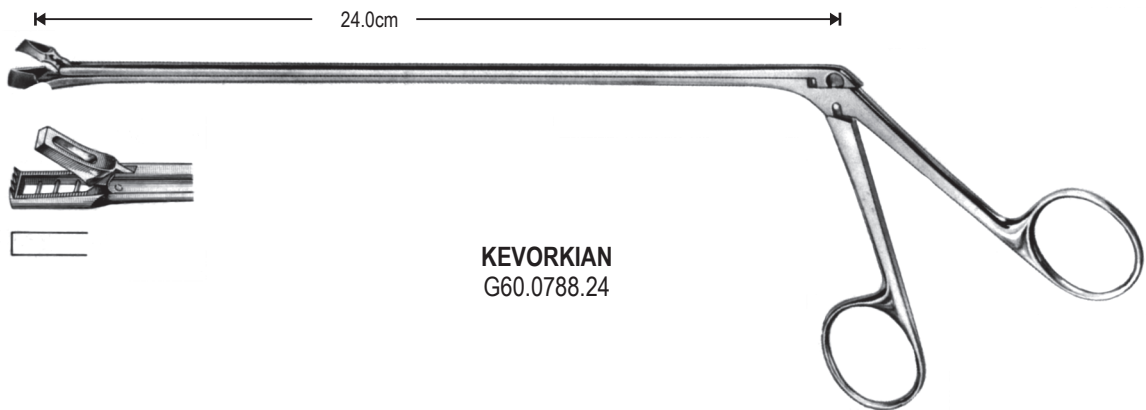
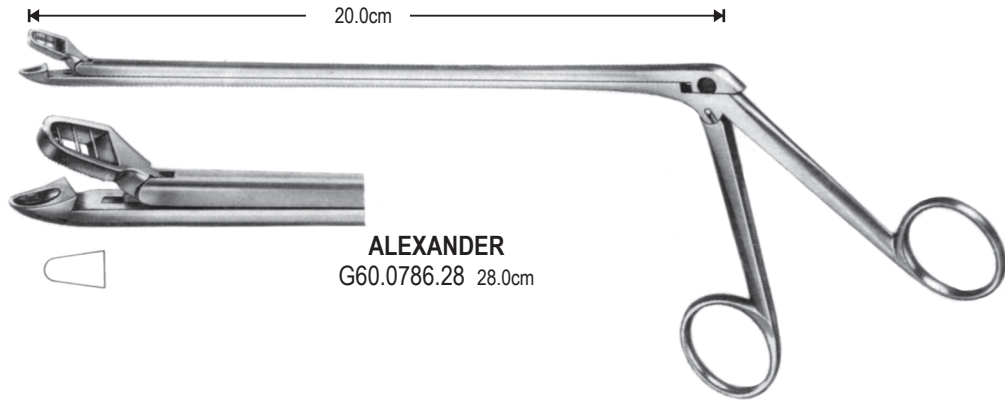
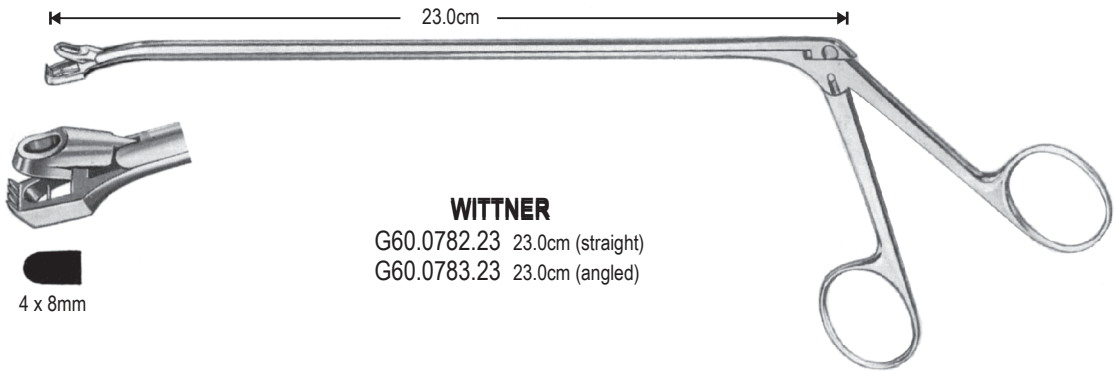

G60-032 G60.0790.02



DE Probeexzisionszangen

EN Cervical Biopsy and Specimen Forceps

ES Pinzas saca-bocados para biopsia

AR الملقط خزعة عنق الرحم ونموذج



2.3 x 4.2 mm



TOWNSEND-MINI
G60.0792.00

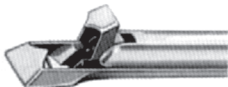

3 x 9.5 mm



TISCHLER-KEVORKIAN
G60.0794.00



4 x 6.5 mm

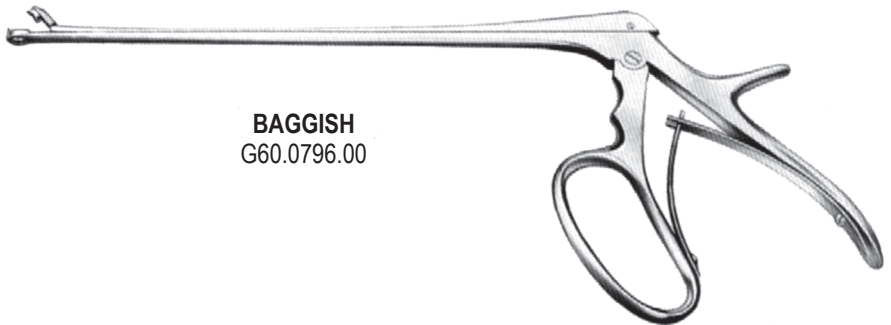

BAGGISH
G60.0796.00



4 x 8 mm

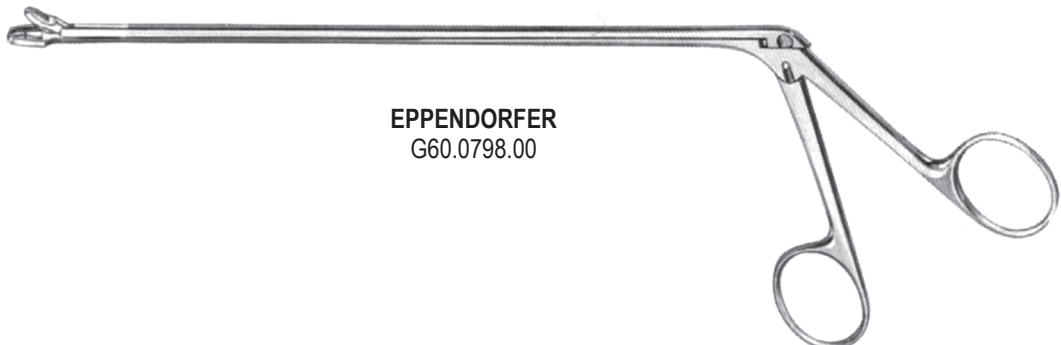

EPPENDORFER
G60.0798.00

G60.0798.00 **G60-033**



G60

Probeexzisionszangen DE
Cervical Biopsy and Specimen Forceps EN
Pinzas saca-bocados para biopsia ES
الملقط خزعة عنق الرحم ونموذج AR

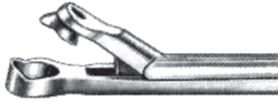

oval
7 x 5 mm

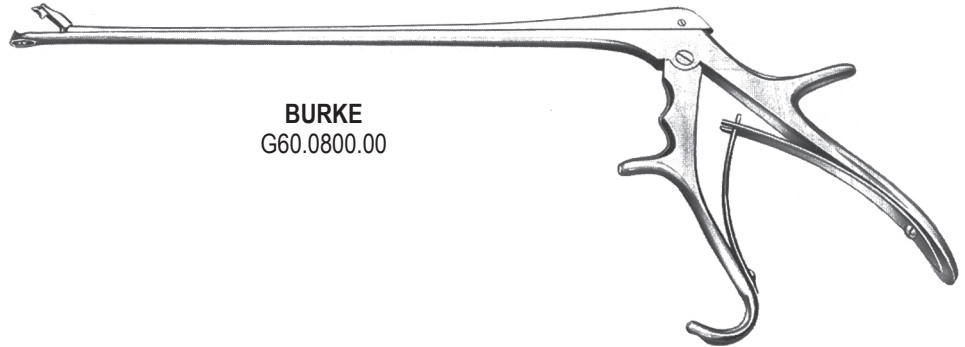

BURKE
G60.0800.00

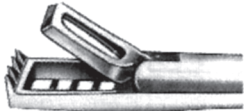

3 x 8 mm



KEVORKIAN-PACIFIC
G60.0802.04



Fig.1

TISCHLER-MORGAN



Fig.3

oval 3.7 x 5 mm

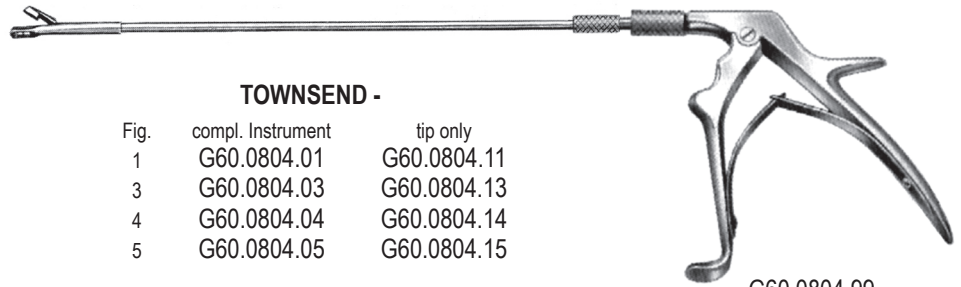

TOWNSEND -

Fig.	compl. Instrument	tip only
1	G60.0804.01	G60.0804.11
3	G60.0804.03	G60.0804.13
4	G60.0804.04	G60.0804.14
5	G60.0804.05	G60.0804.15

G60.0804.99
handle only

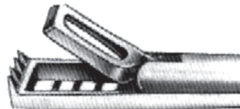

Fig.4

KEVORKIAN

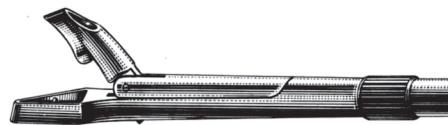

Fig.5

mini



SCHUMACHER
G60.0806.00



Tip only



G60.0806.01

G60-034 G60.0806.01



DE Uterusloffel
EN Uterine Scoops
ES Cucharillas uterinas
AR المجارف الرحم



SIMON
25.0cm, sharp, rigid



SCHROEDER
30.0cm, sharp, rigid



GOURDET
28.0cm, blunt

G60.0830.05 **G60-035**



G60

Uteruskuretten DE

Uterine Curettes EN

Curetas uterinas ES

المجارف الرحم AR

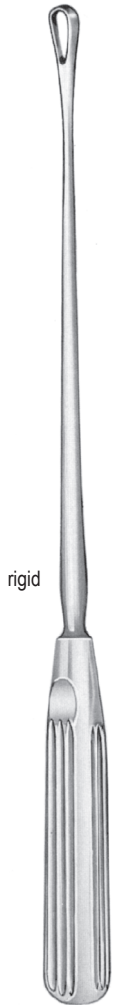

SIMS
31.0cm

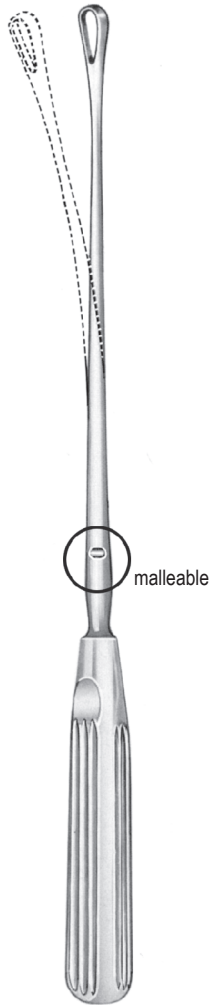

RECAMIER
31.0cm

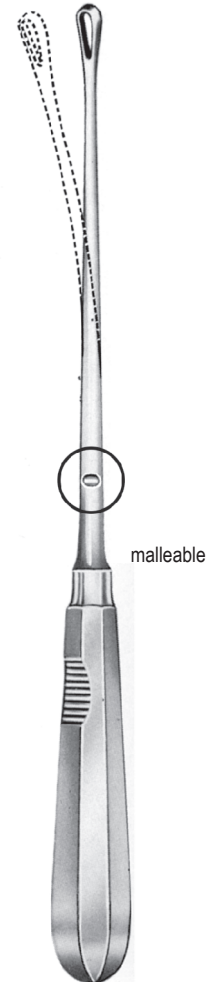
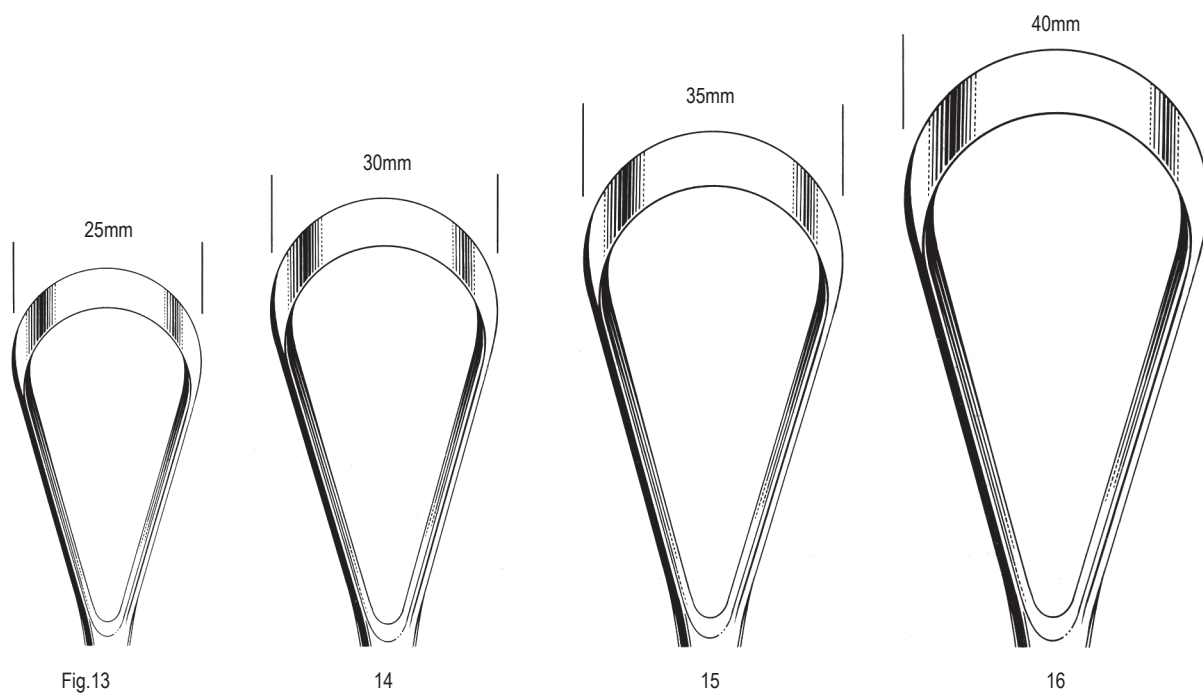
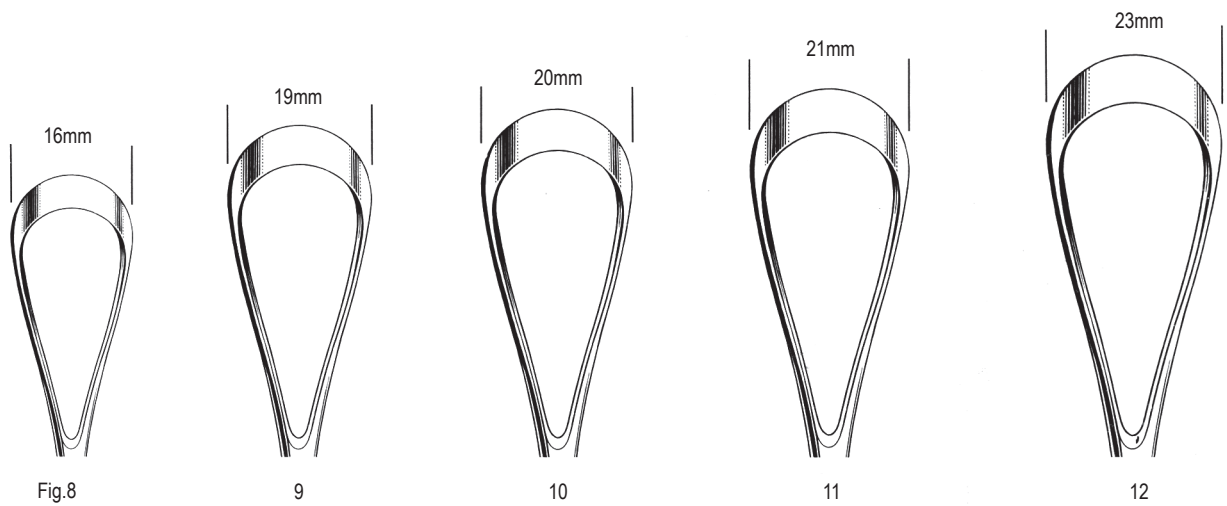
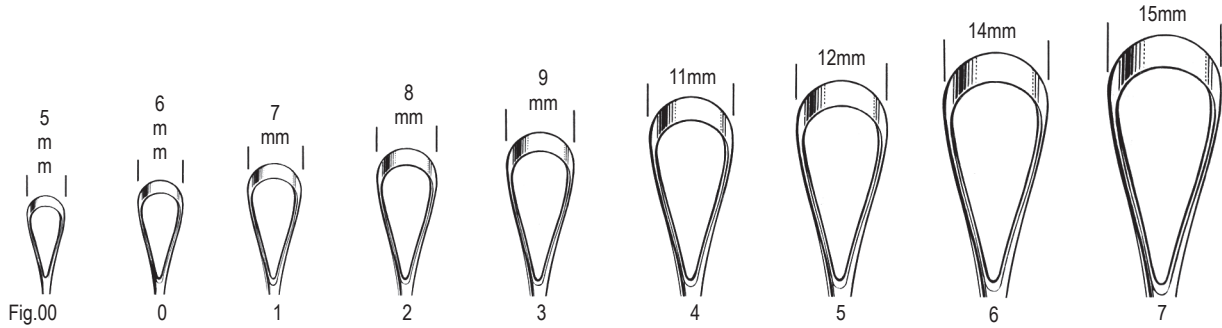

Fig	sharp	blunt	sharp	blunt	Fig	sharp	blunt	sharp	blunt
00	G60.0840.05	G60.0842.05	G60.0844.05	G60.0846.05	00	G60.0850.05	G60.0852.05	G60.0854.05	G60.0856.05
0	G60.0840.06	G60.0842.06	G60.0844.06	G60.0846.06	0	G60.0850.06	G60.0852.06	G60.0854.06	G60.0856.06
1	G60.0840.07	G60.0842.07	G60.0844.07	G60.0846.07	1	G60.0850.07	G60.0852.07	G60.0854.07	G60.0856.07
2	G60.0840.08	G60.0842.08	G60.0844.08	G60.0846.08	2	G60.0850.08	G60.0852.08	G60.0854.08	G60.0856.08
3	G60.0840.09	G60.0842.09	G60.0844.09	G60.0846.09	3	G60.0850.09	G60.0852.09	G60.0854.09	G60.0856.09
4	G60.0840.11	G60.0842.11	G60.0844.11	G60.0846.11	4	G60.0850.11	G60.0852.11	G60.0854.11	G60.0856.11
5	G60.0840.12	G60.0842.12	G60.0844.12	G60.0846.12	5	G60.0850.12	G60.0852.12	G60.0854.12	G60.0856.12
6	G60.0840.14	G60.0842.14	G60.0844.14	G60.0846.14	6	G60.0850.14	G60.0852.14	G60.0854.14	G60.0856.14
7	G60.0840.15	G60.0842.15	G60.0844.15	G60.0846.15	7	G60.0850.15	G60.0852.15	G60.0854.15	G60.0856.15
8	G60.0840.16	G60.0842.16	G60.0844.16	G60.0846.16	8	G60.0850.16	G60.0852.16	G60.0854.16	G60.0856.16
9	G60.0840.19	G60.0842.19	G60.0844.19	G60.0846.19	9	G60.0850.19	G60.0852.19	G60.0854.19	G60.0856.19
10	G60.0840.20	G60.0842.20	G60.0844.20	G60.0846.20	10	G60.0850.20	G60.0852.20	G60.0854.20	G60.0856.20
11	G60.0840.21	G60.0842.21	G60.0844.21	G60.0846.21	11	G60.0850.21	G60.0852.21	G60.0854.21	G60.0856.21
12	G60.0840.23	G60.0842.23	G60.0844.23	G60.0846.23	12	G60.0850.23	G60.0852.23	G60.0854.23	G60.0856.23
13	G60.0840.25	G60.0842.25	G60.0844.25	G60.0846.25	13	G60.0850.25	G60.0852.25	G60.0854.25	G60.0856.25
14	G60.0840.30	G60.0842.30	G60.0844.30	G60.0846.30	14	G60.0850.30	G60.0852.30	G60.0854.30	G60.0856.30
15	G60.0840.35	G60.0842.35	G60.0844.35	G60.0846.35	15	G60.0850.35	G60.0852.35	G60.0854.35	G60.0856.35
16	G60.0840.40	G60.0842.40	G60.0844.40	G60.0846.40	16	G60.0850.40	G60.0852.40	G60.0854.40	G60.0856.40

G60-036 G60.0856.40



DE Uterusloffel
EN Uterine Scoops
ES Cucharillas uterinas
AR المجارف الرحم



G60.0856.40 G60-037



G60

Uteruskuretten DE

Uterine Curettes EN

Curetas uterinas ES

المجارف الرحم AR



BUMM
34.0cm

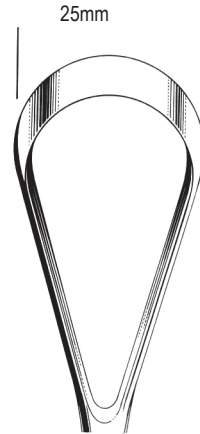
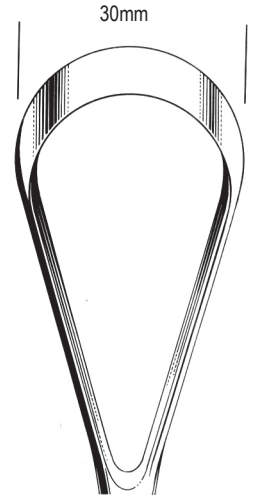
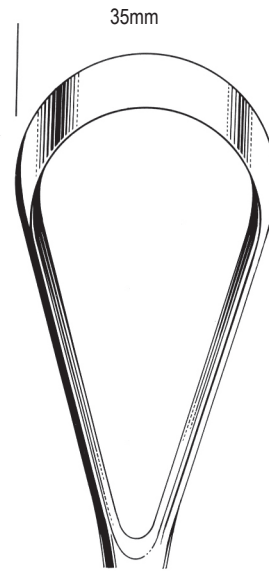

Fig. 13



14



15



16

Fig	sharp	blunt	sharp	blunt
13	G60.0860.25	G60.0862.25	G60.0864.25	G60.0866.25
14	G60.0860.30	G60.0862.30	G60.0864.30	G60.0866.30
15	G60.0860.35	G60.0862.35	G60.0864.35	G60.0866.35
16	G60.0860.40	G60.0862.40	G60.0864.40	G60.0866.40

G60-038 G60.0866.40



DE Uterusloffel
EN Uterine Scoops
ES Cucharillas uterinas
AR المجارف الرحم

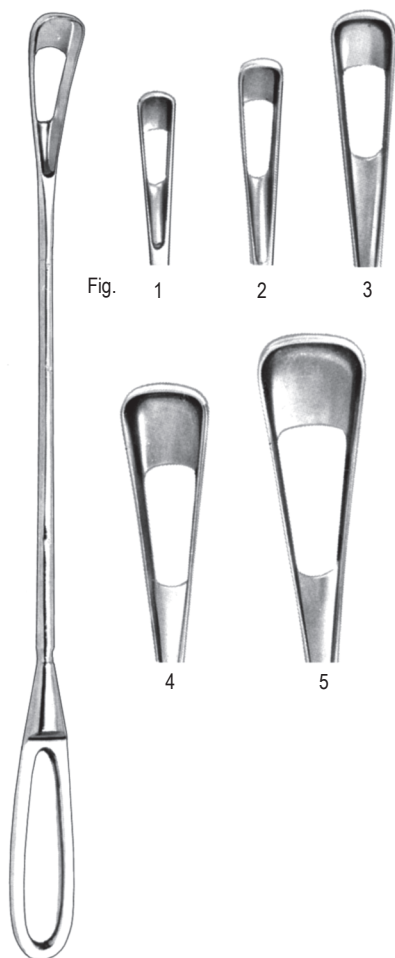

Fig. 1 2 3



4 5

28.0cm

Fig.		mm
1	G60.0870.01	4.5
2	G60.0870.02	6
3	G60.0870.03	9
4	G60.0870.04	12
5	G60.0870.05	15

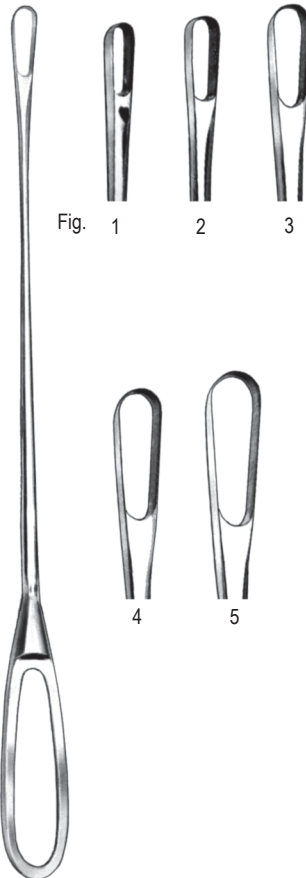
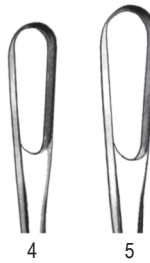

Fig. 1 2 3



4 5

27.0cm

Fig.	
1	G60.0874.01
2	G60.0874.02
3	G60.0874.03
4	G60.0874.04
5	G60.0874.05

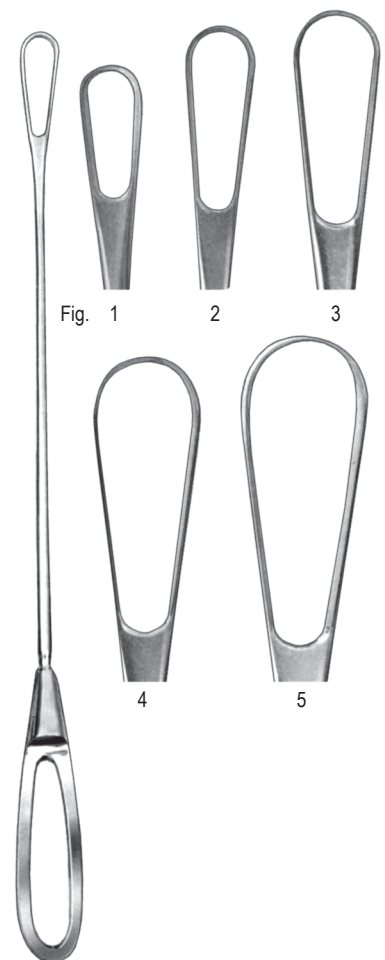

Fig. 1 2 3



4 5

28.0cm

Fig.	
1	G60.0878.01
2	G60.0878.02
3	G60.0878.03
4	G60.0878.04
5	G60.0878.05



G60

Uteruskuretten DE

Uterine Curettes EN

Curetas uterinas ES

المجارف الرحم AR

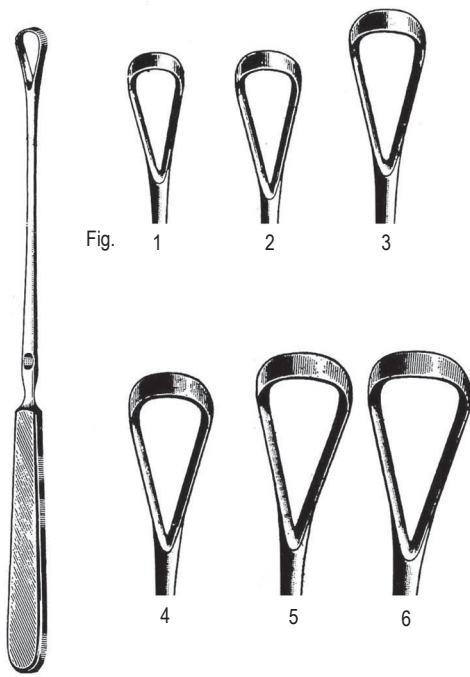

Fig.

1

2

3

4

5

6

SIMS

25.0cm

sharp

Fig

blunt

G60.0880.01	1	G60.0882.01
G60.0880.02	2	G60.0882.02
G60.0880.03	3	G60.0882.03
G60.0880.04	4	G60.0882.04
G60.0880.05	5	G60.0882.05
G60.0880.06	6	G60.0882.06

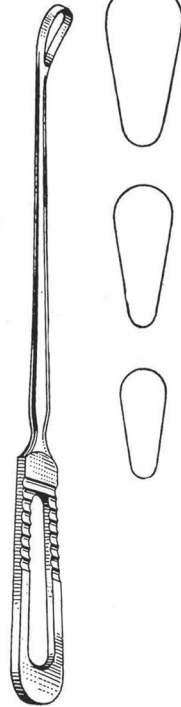

SIMS

25.0cm

sharp

Fig

blunt

G60.0884.01	1	G60.0886.01
G60.0884.02	2	G60.0886.02
G60.0884.03	3	G60.0886.03

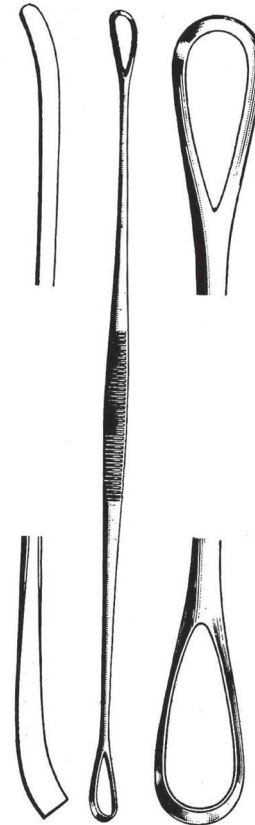

sharp / blunt
G60.0890.27 27.0cm



BLAKE
sharp / blunt
G60.0894.27 27.0cm

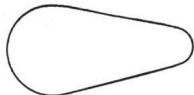

SIMS
G60.0900.25
25.0cm, sharp

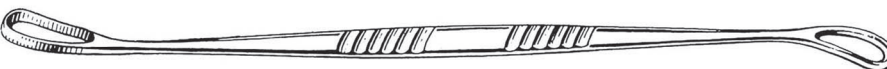
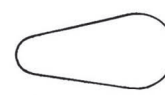

SIMS
G60.0902.25
25.0cm, sharp / blunt



G60-040 G60.0902.25



DE Uterusloffel
 EN Uterine Scoops
 ES Cucharillas uterinas
 AR المجارف الرحم

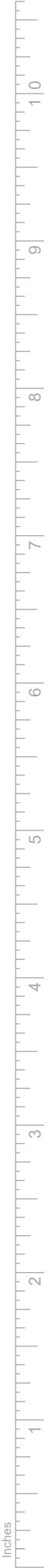
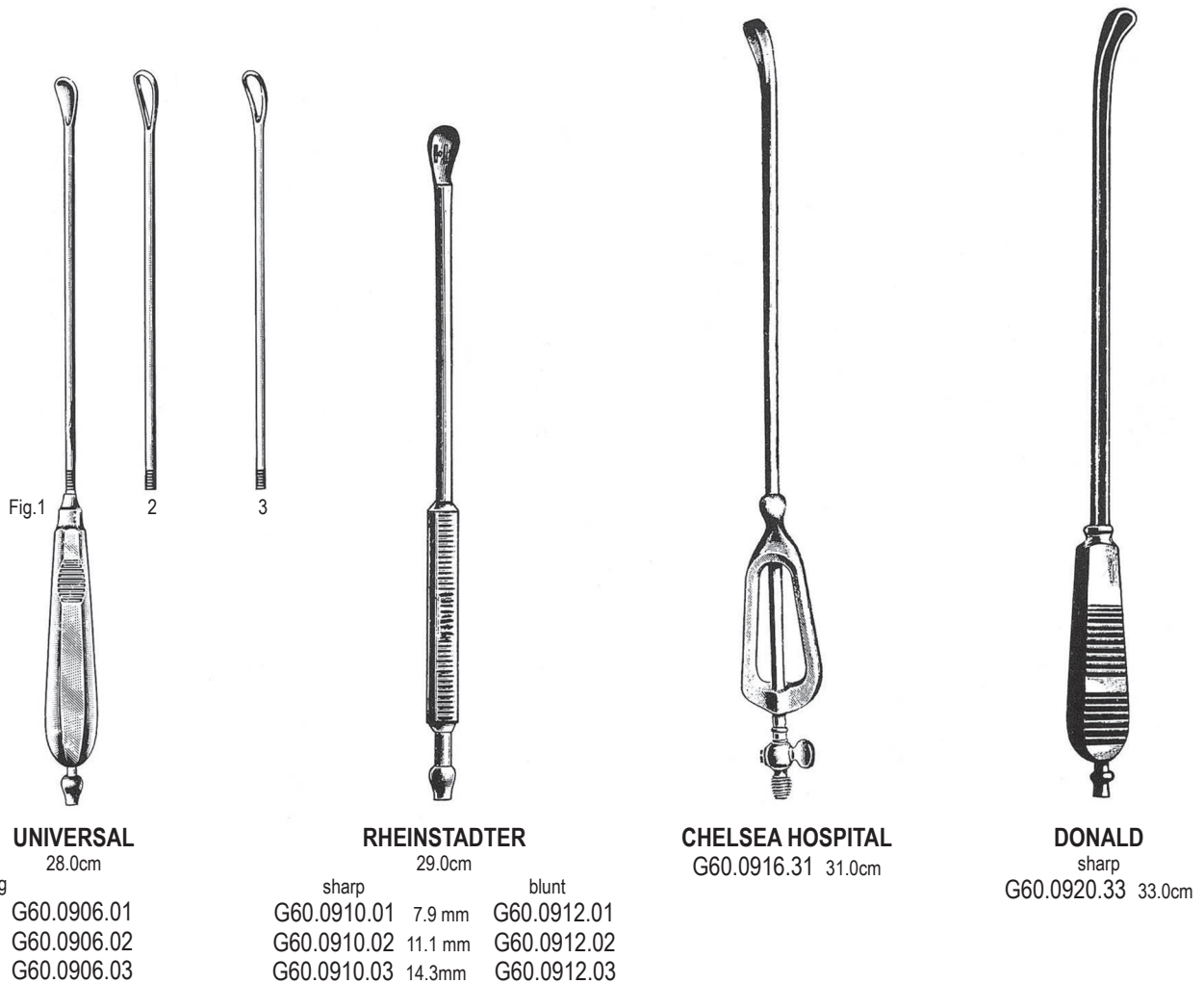

G60

Saug und Biopsiekuretten DE

Suction Biopsy Curettes EN

Curetas aspiradores para biopsia ES

المجارف شفط الخزعة عنق الرحم AR



RANDALL
24.0cm

G60.0924.01 1mm dia.
G60.0924.02 2mm dia.
G60.0924.03 3mm dia.
G60.0924.04 4mm dia.

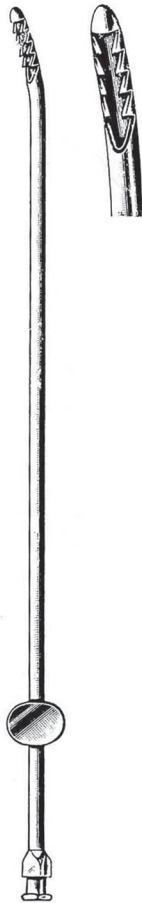

NOVAK
23.0cm

G60.0930.01
G60.0930.02
G60.0930.03
G60.0930.04

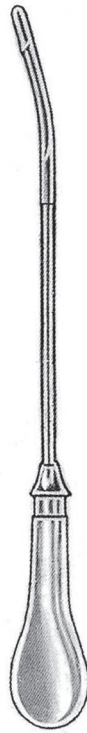

SHERMAN

G60.0934.23 23.0cm
3.5mm dia.

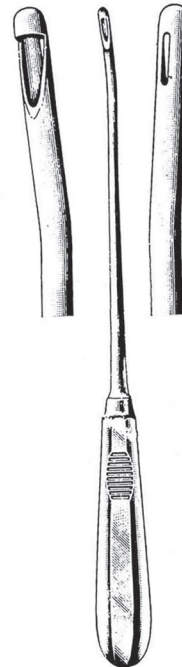

MUENCHEN

G60.0940.27 27.0cm



with basket

KEVORKIAN

30.0cm
G60.0944.12 1.2mm G60.0946.12
G60.0944.40 4.0mm G60.0946.40

G60-042 G60.0946.40

