

- **Medical Equipment**
- **Surgical instruments**

Urologie

DE	Urologie
EN	Urology
ES	Urologia
AR	طب المسالك البولية

G58

PAGE 001 to 013



DE Prostathaken
EN Prostatic Retractors
ES Separadores para la prostata
AR الكامشات البروستاتية



YOUNG
G58.0010.22 22.0cm



YOUNG
G58.0012.21 21.0cm



YOUNG
G58.0014.22 22.0cm



YOUNG
G58.0016.21 21.0cm





67mm

KOCHER
G58.0020.26 26.0cm



35mm

LEGUEU
G58.0024.27 27.0cm

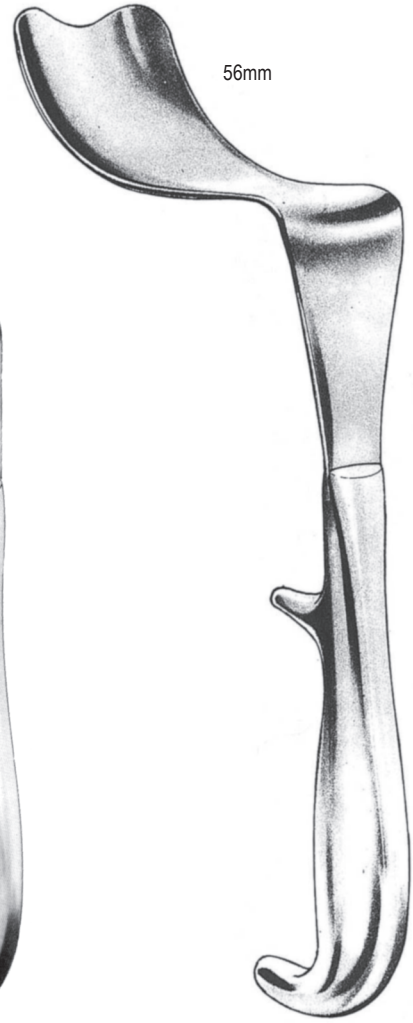

56mm

KOCHER
G58.0028.26 26.0cm



DE **Blasen-Wundspreizer**
EN **Bladder Retractors**
ES **Separadores vesicales**
AR **الكامشات المثانة**

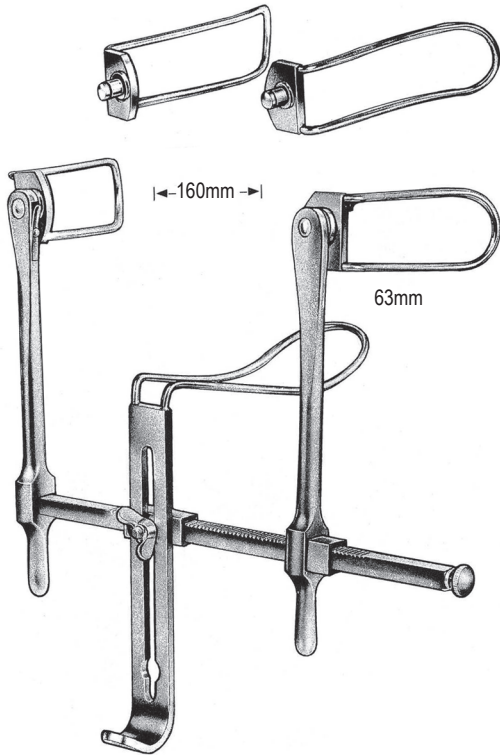

GOSSET
G58.0040.00



THOMSON-WALKER
G58.0050.00

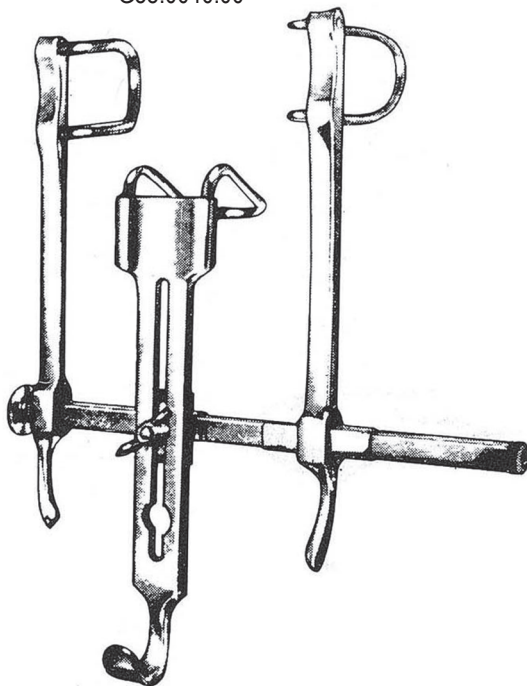

PANTINGS
G58.0060.00



JUDD-MASSON
G58.0064.00

G58.0064.00 **G58-003**



G58

Blasen-Wundspreizer DE
Bladder Retractors EN
Separadores vesicales ES
الكامشات المثانة AR

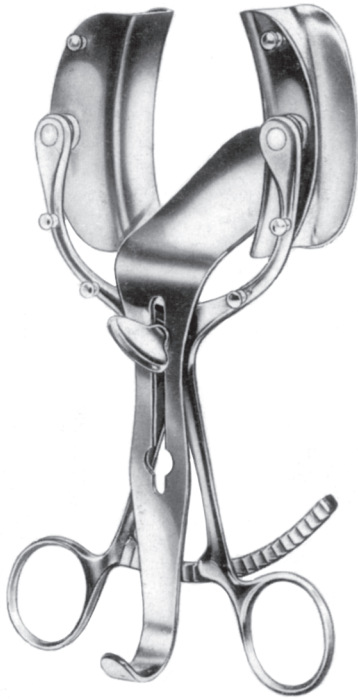

LEGUEU
G58.0070.00



MILLIN
G58.0074.00

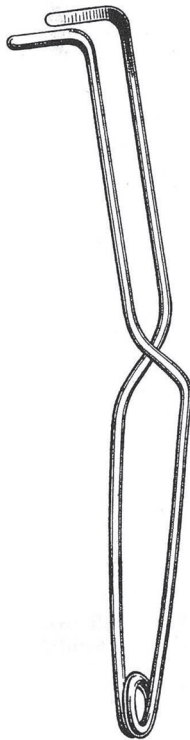

MILLIN
G58.0080.00

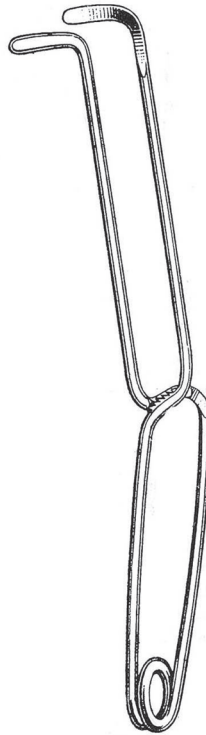

MILLIN
G58.0082.00



MILLIN
G58.0084.00

G58-004 G58.0084.00



DE Klemmen für Prostata-Operationen

EN Prostatectomy Forceps

ES Pinzas para prostatectomía

AR الملقط استئصال البروستاتة

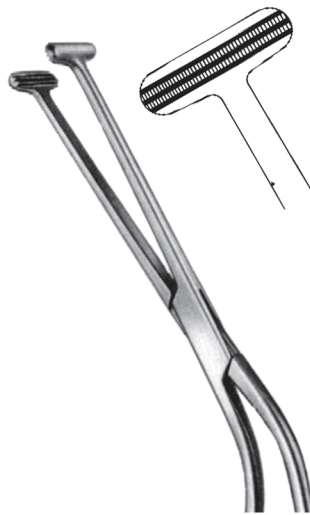

G58.0092.23 23.5cm

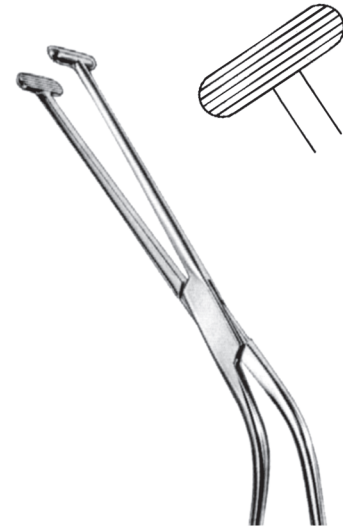

G58.0094.23 23.0cm



MILLIN
G58.0090.24 24.5cm

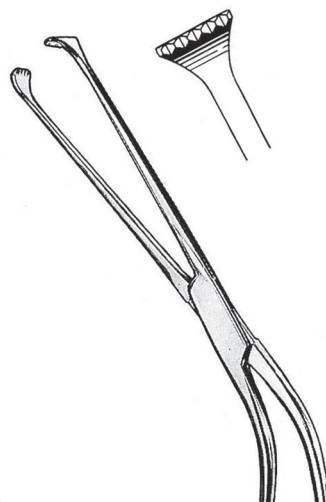

G58.0096.23 23.0cm

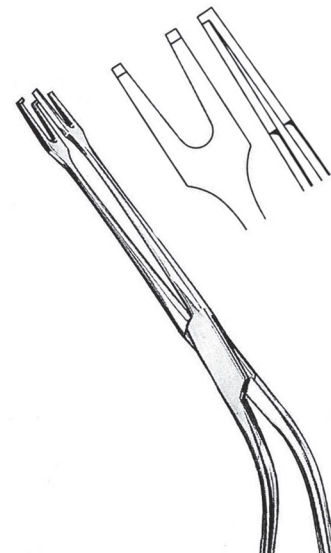

G58.0098.24 24.0cm

G58.0098.24 **G58-005**



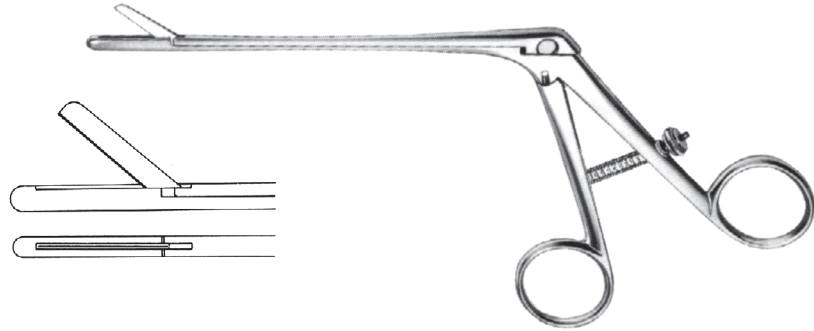

SACHSE
G58.0110.12

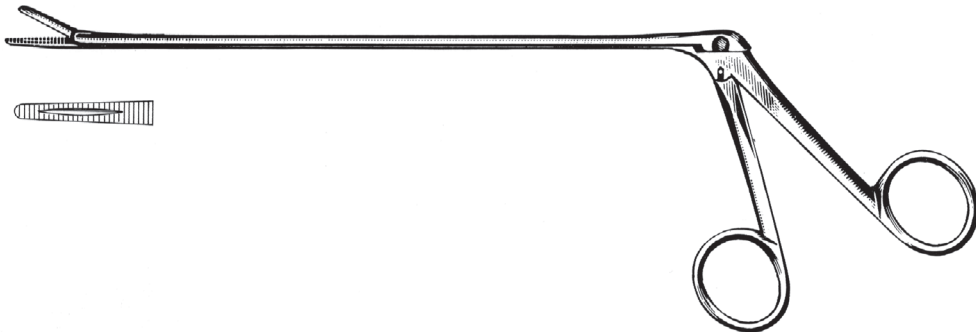

MATHIEU
G58.0114.20 20.0cm
G58.0114.28 28.0cm

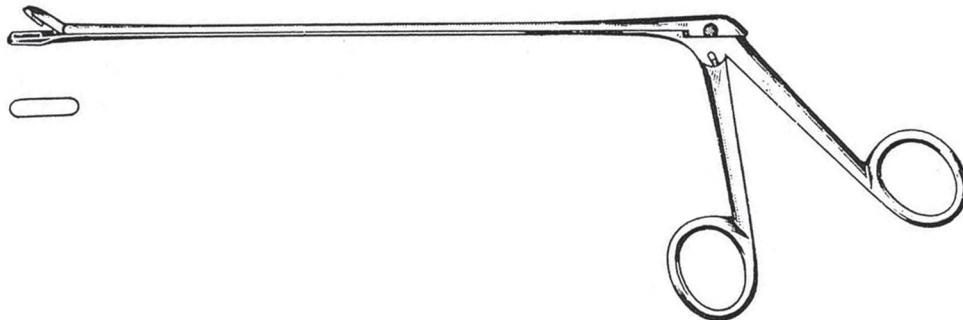

MATHIEU
G58.0120.20 20.0cm
G58.0120.28 28.0cm



- DE Penisklemmen und Steinzgen
- EN Penis Clamp and Lithotomy Forceps
- ES Compresores uretrales y pinzas p/litomia
- AR ملقاط القضيب وملقط استخراج الحصى



STOCKMANN
G58.0130.08



ZIESER MEAEUS CLAMP
G58.0132.10 10.0cm



STRAUSS
G58.0134.11



THOMSON-WALKER
G58.0136.00



LEWKOWITZ
G58.0140.26 26.0cm



G58.0141.26

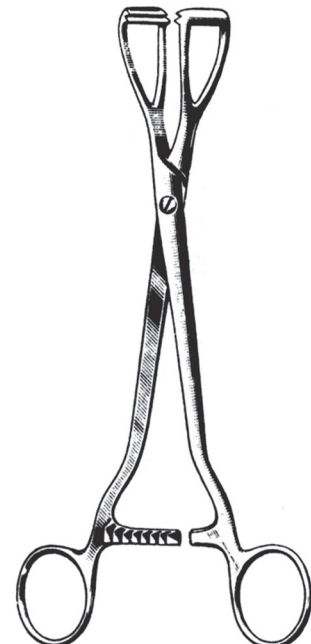

YOUNG
G58.0146.20 20.0cm



G58

Circumcisions Instrumente DE

Circumcision Instruments EN

Instrumentos p/circumisión ES

أدوات الختان AR

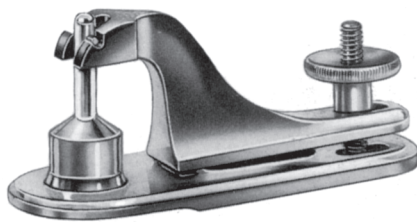

GAMCO

- G58.0150.08 8mm Ø, baby size
- G58.0150.11 11mm Ø, child size
- G58.0150.13 13mm Ø, child size
- G58.0150.16 16mm Ø, adolescent size
- G58.0150.21 21mm Ø, adolescent size
- G58.0150.26 26mm Ø, men's size
- G58.0150.32 32mm Ø, men's size



WINKELMANN

- G58.0156.12 12mm Ø
- G58.0156.16 16mm Ø
- G58.0156.20 20mm Ø

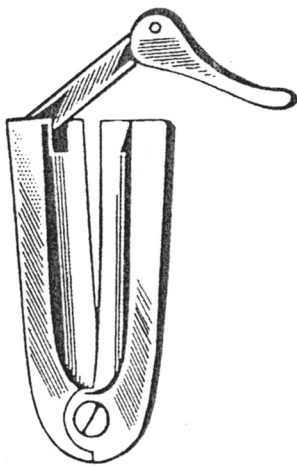

MOGEN

- G58.0160.00
- G58.0162.00

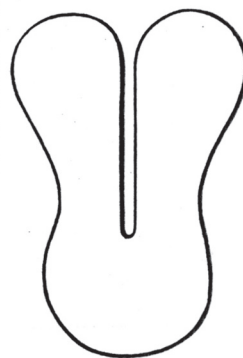

CIRCUMCISION SHIELD

- G58.0164.10 10.0cm



CIRCUMCISION PROBE

- G58.0168.15 15.0cm

G58-008 G58.0168.15

DE Sonden, Aspirationskanulen, Haken für den sanenstrang

EN Hernia Directors, Suction Tube, Cord Hook

ES Sondas, canulas de aspiracion, gancho/el cordon

AR الفتق موجة، متلم شفط أنابيب، خطاف الحبل

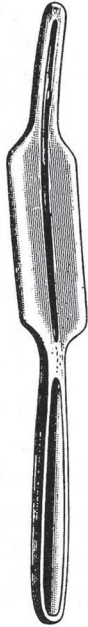

CHILD
G58.0180.00



KEY
G58.0186.00

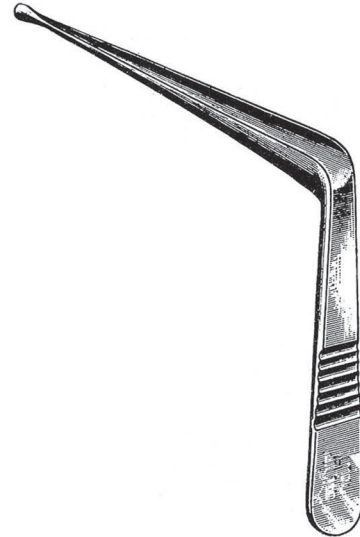

TEALE
G58.0190.00

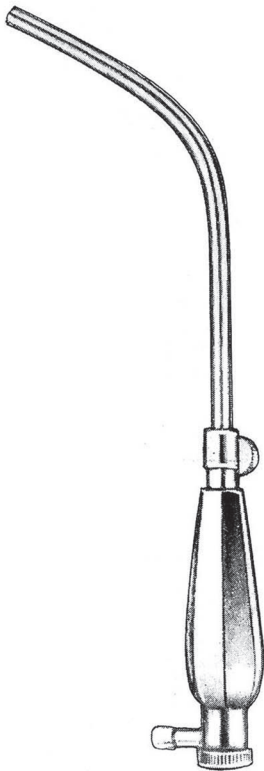

MILLIN
G58.0194.00



CORD HOOK
G58.0200.16 16.0cm



GUTTMANN
G58.0204.26 26.0cm



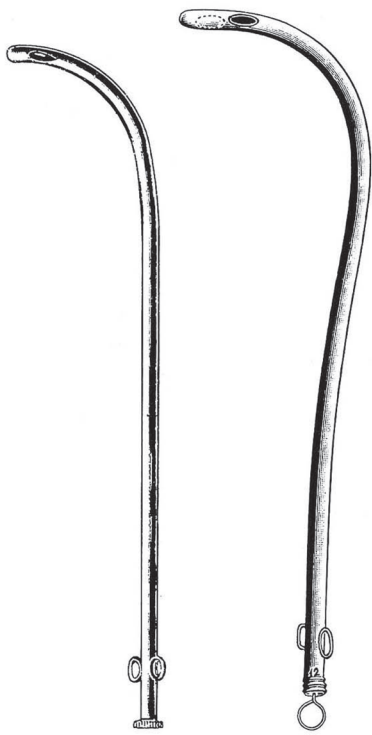

COXETER

F.G.	MALE 27.0cm	28.0cm	FEMALE 15.0cm	MALE 20.0cm
6	G58.0210.06	G58.0216.06	G58.0220.06	G58.0226.06
8	G58.0210.08	G58.0216.08	G58.0220.08	G58.0226.08
10	G58.0210.10	G58.0216.10	G58.0220.10	G58.0226.10
12	G58.0210.12	G58.0216.12	G58.0220.12	G58.0226.12
14	G58.0210.14	G58.0216.14	G58.0220.14	G58.0226.14
16	G58.0210.16	G58.0216.16	G58.0220.16	G58.0226.16
18	G58.0210.18	G58.0216.18	G58.0220.18	G58.0226.18
20	G58.0210.20	G58.0216.20	G58.0220.20	G58.0226.20
22	G58.0210.22	G58.0216.22	G58.0220.22	G58.0226.22
24	G58.0210.24	G58.0216.24	G58.0220.24	G58.0226.24

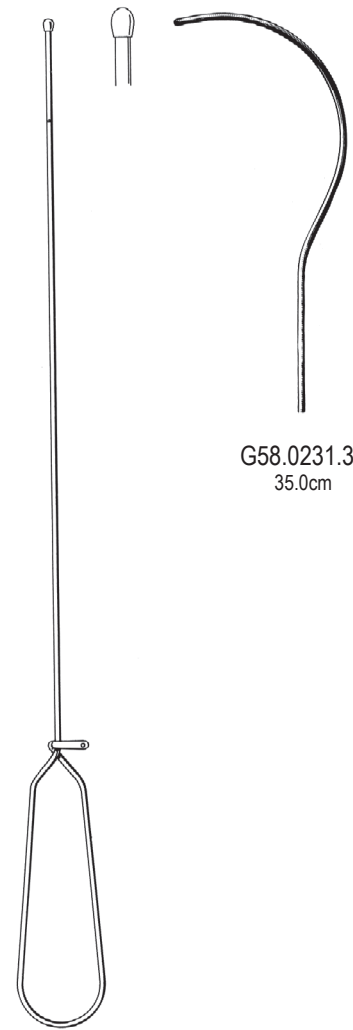

G58.0231.35
35.0cm

G58.0230.39
39.0cm



DE Dilationsbougies
EN Dilating Bougies
ES Bujias Dilatorias
AR الموسعات

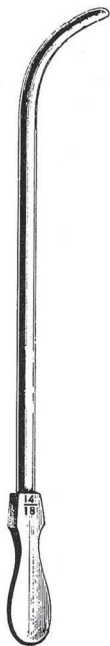

CLUTTON

set	G58.0236.00
F.G.	
06/10	G58.0236.06
08/12	G58.0236.08
10/14	G58.0236.10
12/16	G58.0236.12
14/18	G58.0236.14
16/20	G58.0236.16
18/22	G58.0236.18
20/24	G58.0236.20
22/26	G58.0236.22
24/28	G58.0236.24
26/30	G58.0236.26
28/32	G58.0236.28



LISTER

set	G58.0240.00
F.G.	
00/1	G58.0240.01
0/2	G58.0240.02
1/3	G58.0240.03
1/4	G58.0240.04
2/5	G58.0240.05
3/6	G58.0240.06
4/7	G58.0240.07
5/8	G58.0240.08
6/9	G58.0240.09
7/10	G58.0240.10
8/11	G58.0240.11
9/12	G58.0240.12
10/13	G58.0240.13
11/14	G58.0240.14
12/15	G58.0240.15
13/16	G58.0240.16
14/17	G58.0240.17
15/18	G58.0240.18



WHEELHOUSE

G58.0250.00

F.G.	
06	G58.0246.06
08	G58.0246.08
10	G58.0246.10
12	G58.0246.12
14	G58.0246.14
16	G58.0246.16



G58



VAN BUREN
G58.0260.00
set No. 8-36

(French)

- 8 G58.0260.08
- 9
- 10 G58.0260.10
- 11
- 12 G58.0260.12
- 13
- 14 G58.0260.14
- 15
- 16 G58.0260.16
- 17
- 18 G58.0260.18
- 19
- 20 G58.0260.20
- 21
- 22 G58.0260.22
- 23
- 24 G58.0260.24
- 25
- 26 G58.0260.26
- 27
- 28 G58.0260.28
- 29
- 30 G58.0260.30
- 31 G58.0260.31
- 32 G58.0260.32
- 33 G58.0260.33
- 34 G58.0260.34
- 35 G58.0260.35
- 36 G58.0260.36



GUYON
G58.0270.00
set No. 10-30

- G58.0270.10
- G58.0270.11
- G58.0270.12
- G58.0270.13
- G58.0270.14
- G58.0270.15
- G58.0270.16
- G58.0270.17
- G58.0270.18
- G58.0270.19
- G58.0270.20
- G58.0270.21
- G58.0270.22
- G58.0270.23
- G58.0270.24
- G58.0270.25
- G58.0270.26
- G58.0270.27
- G58.0270.28
- G58.0270.29
- G58.0270.30



GUYON
G58.0272.00
set No. 10-30

- G58.0272.10
- G58.0272.11
- G58.0272.12
- G58.0272.13
- G58.0272.14
- G58.0272.15
- G58.0272.16
- G58.0272.17
- G58.0272.18
- G58.0272.19
- G58.0272.20
- G58.0272.21
- G58.0272.22
- G58.0272.23
- G58.0272.24
- G58.0272.25
- G58.0272.26
- G58.0272.27
- G58.0272.28
- G58.0272.29
- G58.0272.30



DITTEL
G58.0280.00
set No.10-30

- G58.0280.10
- G58.0280.11
- G58.0280.12
- G58.0280.13
- G58.0280.14
- G58.0280.15
- G58.0280.16
- G58.0280.17
- G58.0280.18
- G58.0280.19
- G58.0280.20
- G58.0280.21
- G58.0280.22
- G58.0280.23
- G58.0280.24
- G58.0280.25
- G58.0280.26
- G58.0280.27
- G58.0280.28
- G58.0280.29
- G58.0280.30



DITTEL
G58.0282.00
set No.8-30

- G58.0282.08
- G58.0282.09
- G58.0282.10
- G58.0282.11
- G58.0282.12
- G58.0282.13
- G58.0282.14
- G58.0282.15
- G58.0282.16
- G58.0282.17
- G58.0282.18
- G58.0282.19
- G58.0282.20
- G58.0282.21
- G58.0282.22
- G58.0282.23
- G58.0282.24
- G58.0282.25
- G58.0282.26
- G58.0282.27
- G58.0282.28
- G58.0282.29
- G58.0282.30

G58-012 G58.0282.30



DE Dilatationsbesteck
EN Set of Dilating Sounds
ES Juego de bujias dilatadoras
AR طقم الموسعات

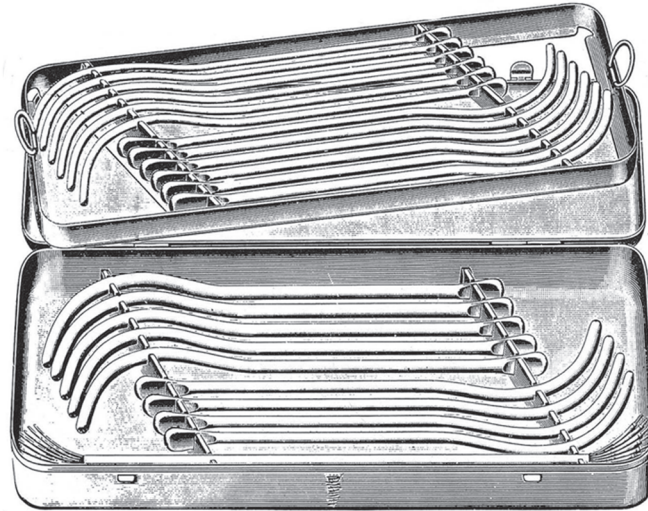

VAN BUREN
G58.0290.00
420x175x40 mm
set in metal case containing
21 bougies



GUYON
G58.0291.00
420x175x40mm
set in metal case containing
21 bougies
6 liliform in metal tube

G58.0291.00 **G58-013**





www.gsi-medical.de