

- **Medical Equipment**
- **Surgical instruments**

Rektum

DE	Rektum
EN	Rectum
ES	Recto
AR	المستقيم

G54

PAGE 001 to 012



- DE Mastdarm-Spekule
- EN Rectal Specula
- ES Especulos rectales
- AR مناظير المستقيم

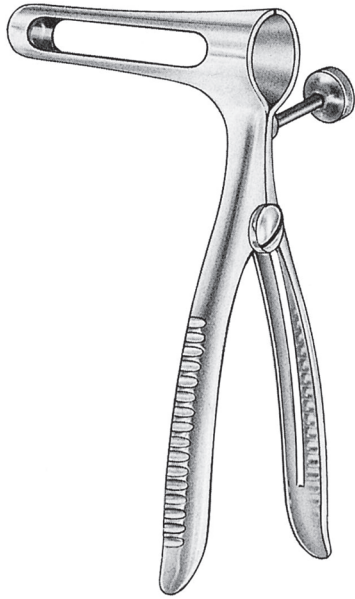

SIMS
G54.0010.15 15.0cm

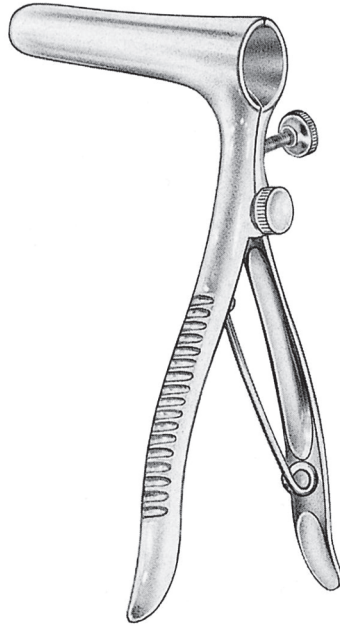

SIMS
G54.0012.15 15.0cm

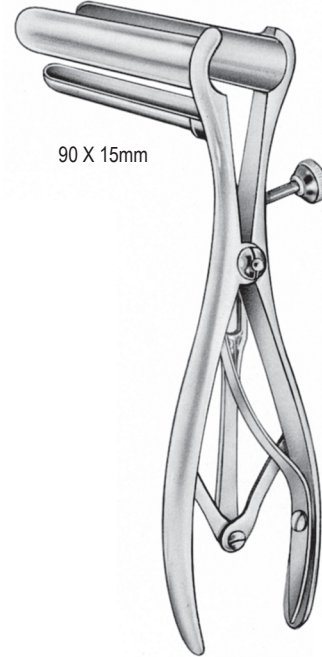

MATHIEU
G54.0020.19 19.5cm

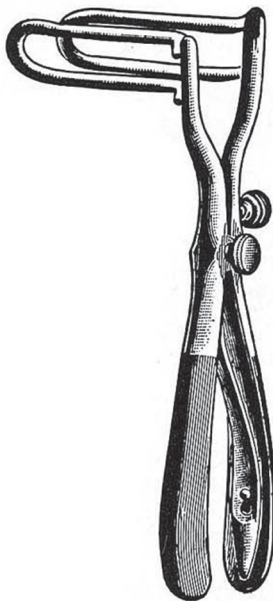

SIMS
G54.0030.15 15.0cm

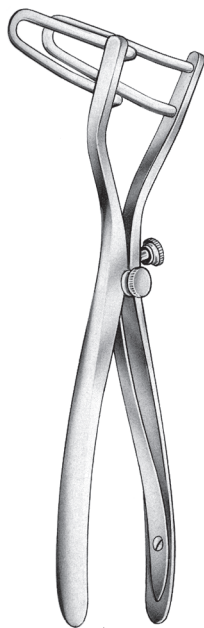

SCHULZE-BERGMANN
22.0cm
G54.0040.06 60mm
G54.0040.08 80mm
G54.0040.12 125mm
G54.0040.15 150mm

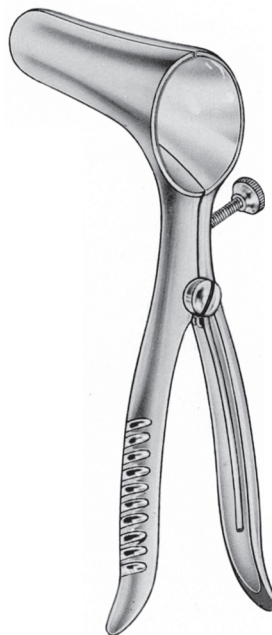

PRATT
G54.0050.21 21.5cm

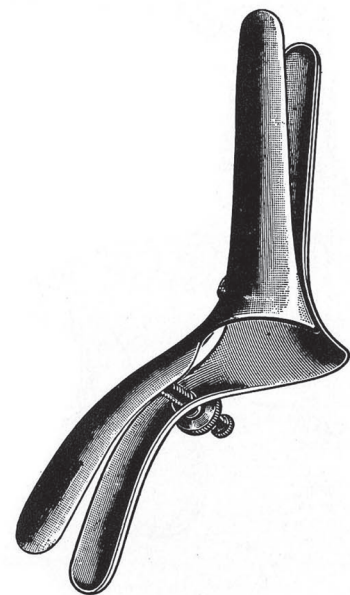

RICORD
G54.0060.00

G54.0060.00 **G54-001**



G54

Proktoskope DE

Proctoscopes EN

Proctoscopios ES

منظار المستقيم AR



KELLY

G54.0070.01 21mm Ø x 50mm

G54.0070.02 27mm Ø x 50mm

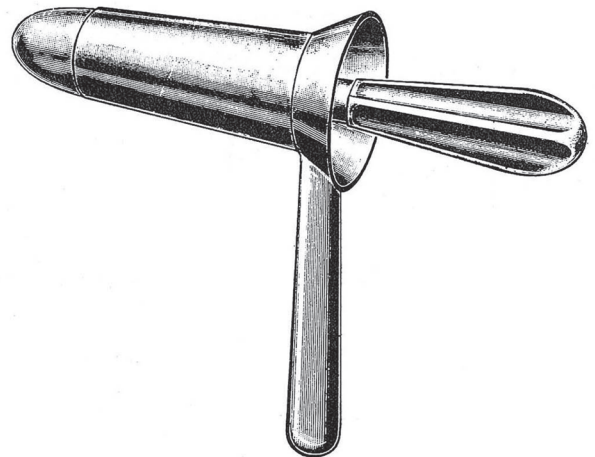

KELLY

G54.0074.01 25mm Ø x 64mm

G54.0074.02 22mm Ø x 35mm

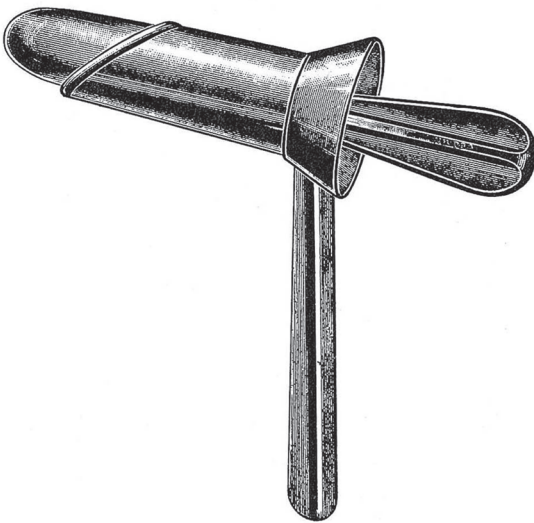

GRAEME-ANDERSON

G54.0080.00 24mm Ø x 64mm



GABRIEL

G54.0090.01 24mm Ø x 64mm

G54.0090.02 19mm Ø x 49mm

G54-002 G54.0090.02



DE Proktoskope, Anoskop

EN Proctoscopes, Anoscope

ES Proctoscopios y anoscopio

AR منظار المستقيم ومنظار الشرج



KELLY

- G54.0100.01 22mm Ø x 50mm
- G54.0100.02 22mm Ø x 100mm
- G54.0100.03 22mm Ø x 140mm
- G54.0100.04 22mm Ø x 200mm

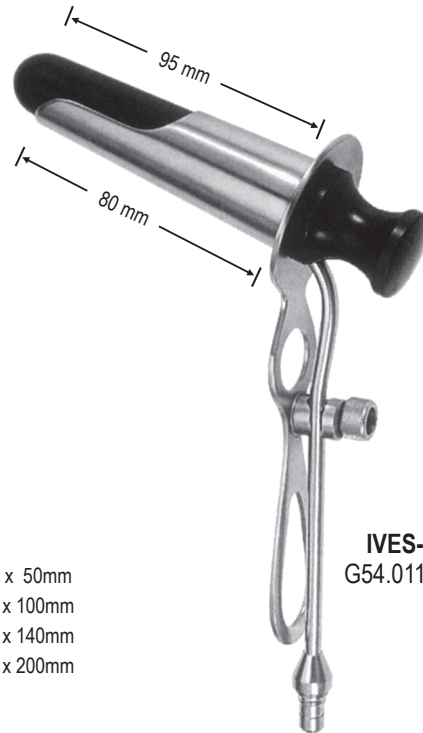

IVES-FANSLER

- G54.0110.15 22mm Ø



HIRSCHMANN

- G54.0120.01 16mm Ø x 65mm
- G54.0120.02 19mm Ø x 65mm
- G54.0120.03 22mm Ø x 65mm



KELLY

- G54.0130.01 22mm Ø x 50mm
- G54.0130.02 22mm Ø x 100mm
- G54.0130.03 22mm Ø x 140mm



G54

Sphinkteroskope, Proktoskope, Anuskope DE
Sphincteroscopes, Proctoscopes, Anoscopes EN
Esfinteroscopios, proctoscopios, anoscopios ES
منظار المصرة، منظار المستقيم ومنظار الشرج AR



MOD. MARTIN

- G54.0140.01 22mm Ø X 50mm
- G54.0140.02 22mm Ø X 75mm
- G54.0140.03 22mm Ø X 100mm



NEWMAN

- G54.0150.01 16mm Ø X 63mm
- G54.0150.02 19mm Ø X 63mm
- G54.0150.03 23mm Ø X 63mm



BENSAUDE

- G54.0160.01 19mmØ X 70mm
- G54.0160.02 22mmØ X 70mm



NAUNTON-MORGAN

- G54.0170.00 22mmØ X 70mm

G54-004 G54.0170.00



DE Mastdarm-Spekule,-Spreizer-Analspreizer

EN Rectal Specula, Anal Retractors

ES Especulos rectales

AR مناظير المستقيم، الكامشات الشرج



BARR
G54.0180.17 17.0cm

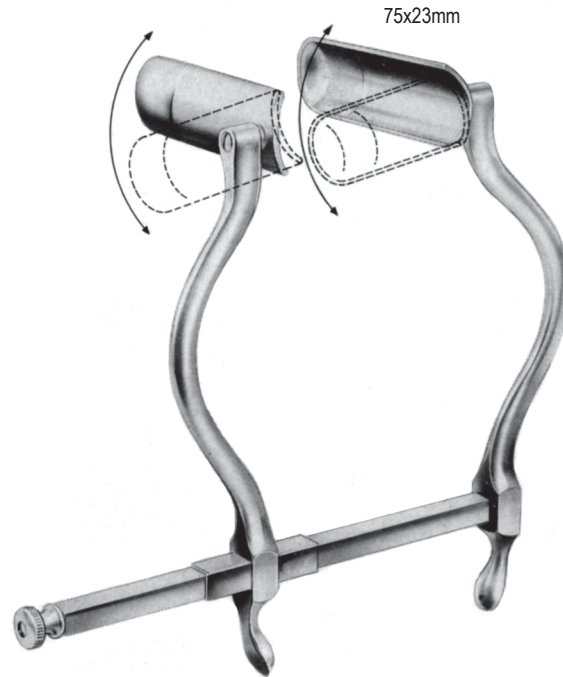

SMITH-BUIE
G54.0190.15 15.0cm



ALAN PARKS
13.5cm
G54.0200.00 complete
G54.0200.04 centre blade
G54.0200.13 frame only



G54.0200.01
72mm



G54.0200.02
90mm



G54.0200.03
94mm

G54.0200.13 **G54-005**



G54

Mastdarm-Specula und Anal Sonden DE

Rectal Specula and Probes EN

Espéculas rectales y sondas ES

مناظير المستقيم و تحقيقات AR

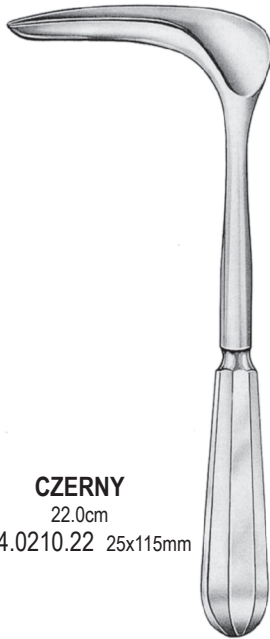

CZERNY
22.0cm
G54.0210.22 25x115mm



SAWYER
23.0cm
G54.0220.01 65x22mm
G54.0220.02 75x28mm
G54.0220.03 90x38mm

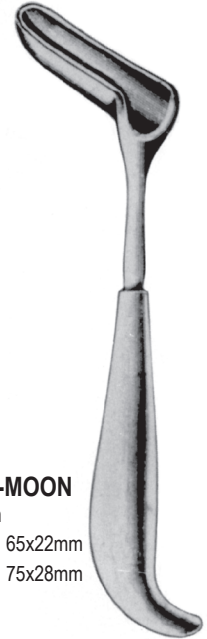

FERGUSON-MOON
21.0cm
G54.0230.01 65x22mm
G54.0230.02 75x28mm



BUIE 13.5cm
G54.0240.13 light
G54.0242.13 heavy



LARRY
G54.0250.18
18.0cm



ROSER
G54.0260.17
17.0cm



PRATT
22.0cm



G54.0270.01

G54.0270.02

GF54.0270.03



BARR
G54.0280.23
23.0cm



BARR
G54.0290.14
14.0cm

G54-006 G54.0290.14

DE Rectal und Fistelsonden

EN Rectal and Fistula Probes

ES Rectal y la fistula sondas

AR مناظير المستقيم، الكامشات الشرج

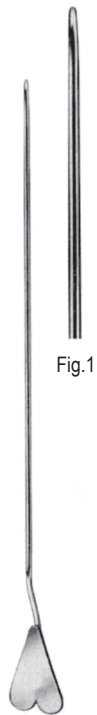

Fig.1

G54.0300.01
Fig.1 straight



Fig.2

G54.0300.02
Fig.2 45° curved

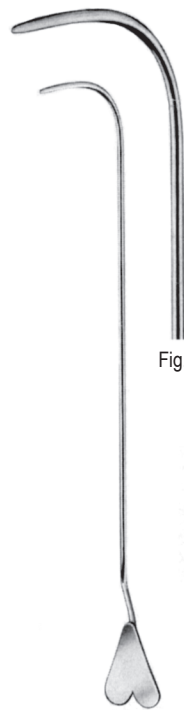

Fig.3

G54.0300.03
Fig.3 90° curved



Fig.4

G54.0300.04
Fig.4 retrograde curved



BRODIE 20.0cm

G54.0310.20

LOCKHART-MUMMERY 16.5cm



G54

Pelvishaken	DE
Pelvis Retractors	EN
Retradores de pelvis	ES
الكامشات الحوض	AR

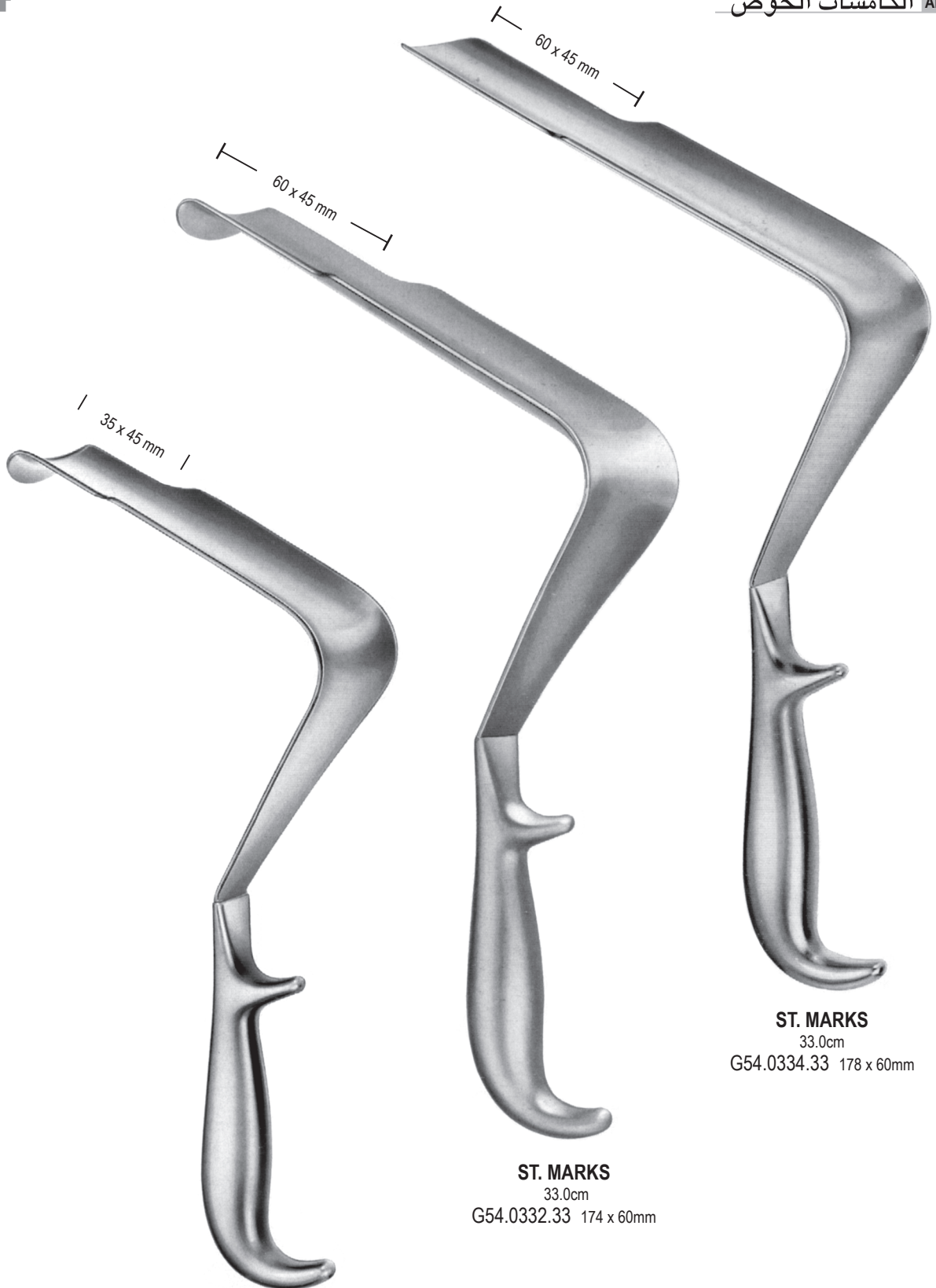

ST. MARKS
29.0cm
G54.0330.29 124x60mm

ST. MARKS
33.0cm
G54.0332.33 174 x 60mm

ST. MARKS
33.0cm
G54.0334.33 178 x 60mm

G54-008 G54.0334.33

DE Hamorrhoidal-Ligator
EN Haemorrhoidal Ligator
ES Hemorroidales ligaduras
AR ربط البواسير

G54.0340.02
ligature rubber rings

McGIVNEY

G54.0340.00 compl.
G54.0340.01 cone
G54.0340.02 100 '0' ring

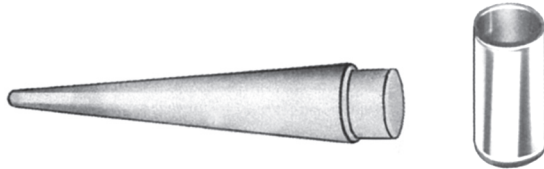
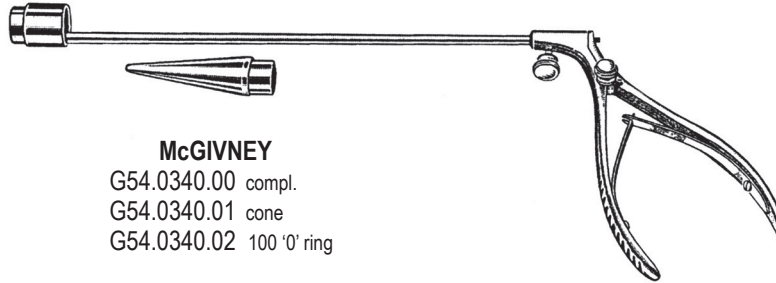

Loading Cone only
G54.0354.01

Suction Head
G54.0354.11 10x11mm
G54.0354.16 10x16mm

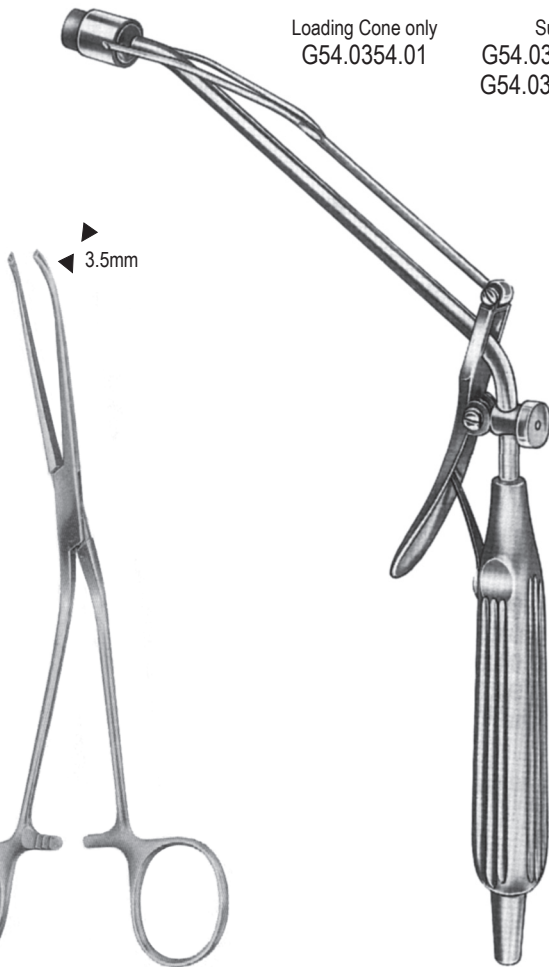

McGIVNEY
G54.0350.18 18.5cm

18.5cm
G54.0354.00 Set
G54.0354.01 Cone
G54.0354.11 Suction Head
G54.0354.16 Suction Head
G54.0340.02 100 '0' ring



RUDD
G54.0360.31 31.5cm
G54.0360.01 cone
G54.0340.02 100 '0' ring

G54.0340.02 **G54-009**



G54

Mastdarm-Biopsiezange, Hämorrhoidalzangen DE

Rectal Biopsy Specimen Forceps, Haemorrhoidal (Pile) Forceps EN

Pinza sacabocado para biopsia rectal, pinzas-clamps hemorroidales ES

الملقط المستقيم الخزعة، الملقط الباسورية AR

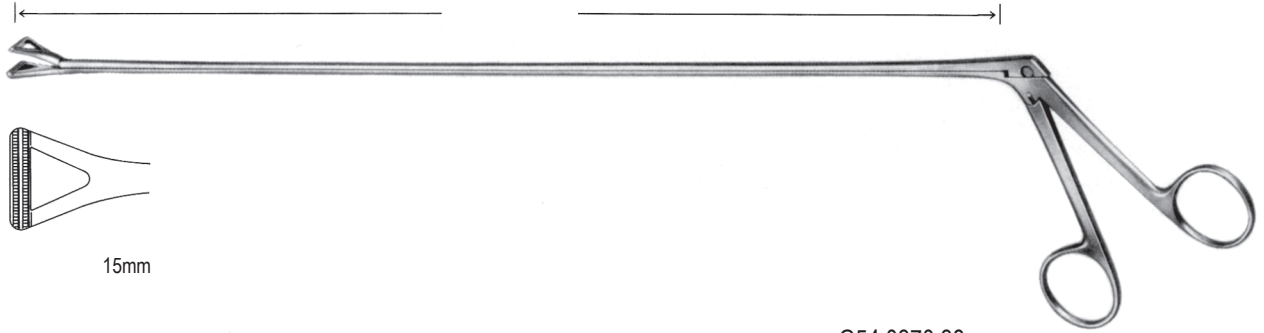

G54.0370.38



HEYWOOD-SMITH
G54.0380.21 21.0cm

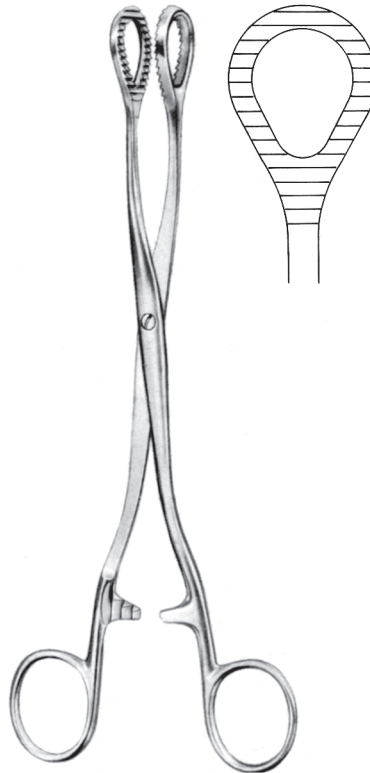

HEYWOOD-SMITH
G54.0382.20 20.0cm



LUER
G54.0390.24 24.5cm

G54-010 G54.0390.24



DE Mastdarm-Biopsiezange
 EN Rectal Biopsy Forceps
 ES Pinzas sacabocado p / biopsia rectal
 AR الملقط المستقيم الخزعة

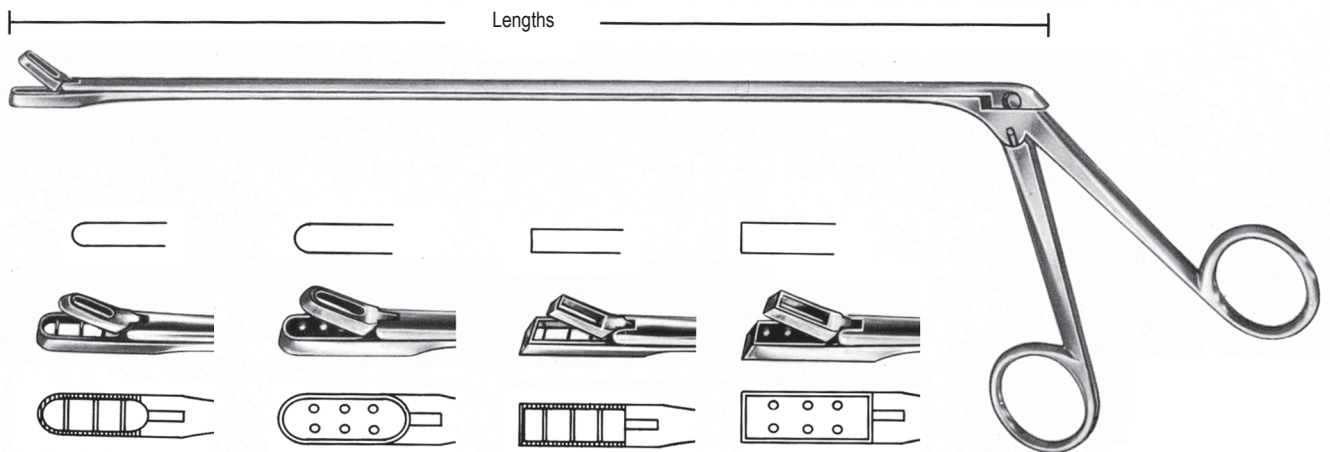
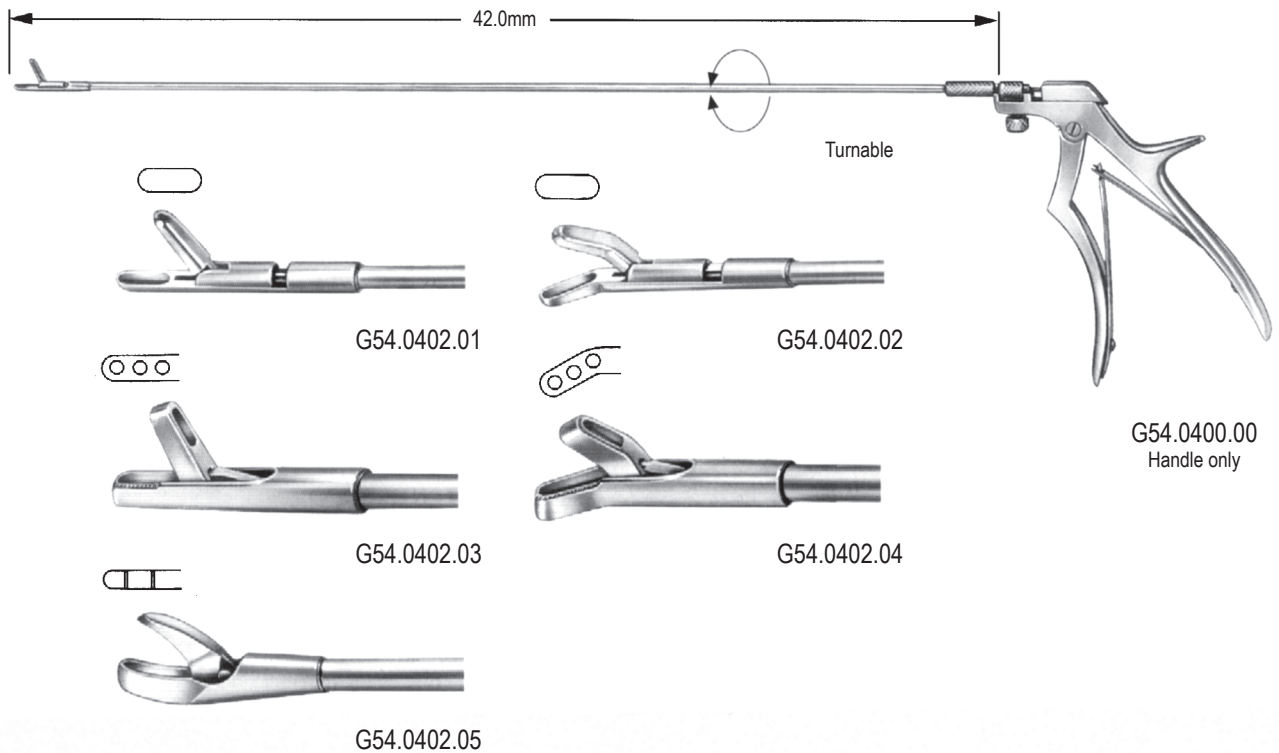

L/shaft	G54.0410.28	G54.0412.28	G54.0414.28	G54.0416.28
28.0cm	G54.0410.28	G54.0412.28	G54.0414.28	G54.0416.28
35.0cm	G54.0410.35	G54.0412.35	G54.0414.35	G54.0416.35
42.0cm	G54.0410.42	G54.0412.42	G54.0414.42	G54.0416.42

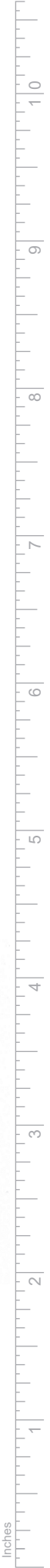

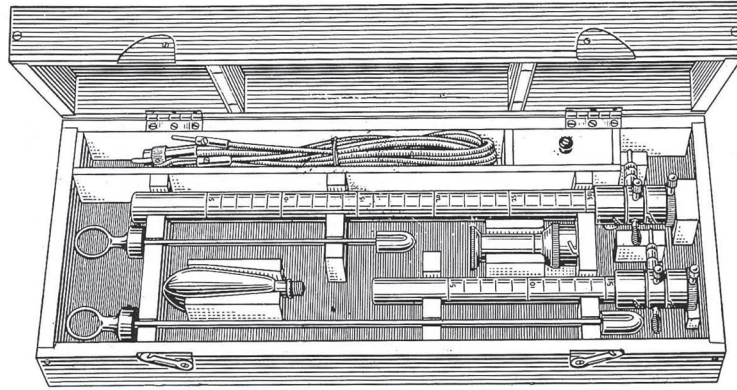

LLOYDS-DAVIES
G54.0420.00 complete

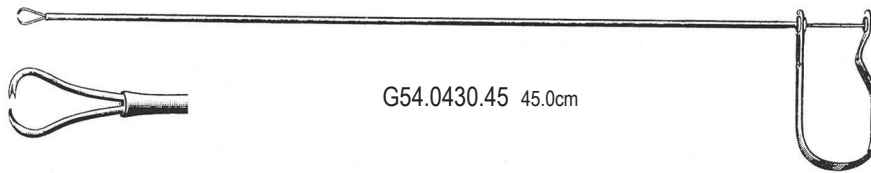

G54.0430.45 45.0cm

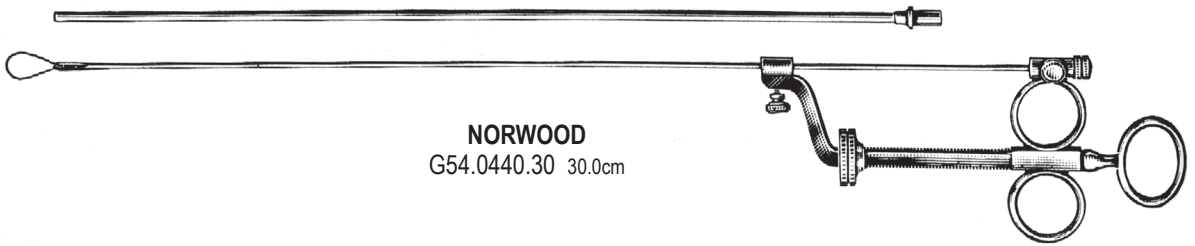

NORWOOD
G54.0440.30 30.0cm

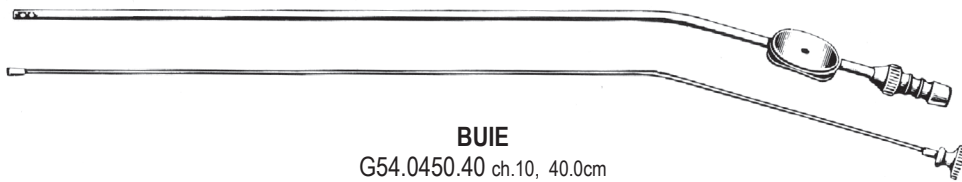

BUIE
G54.0450.40 ch.10, 40.0cm

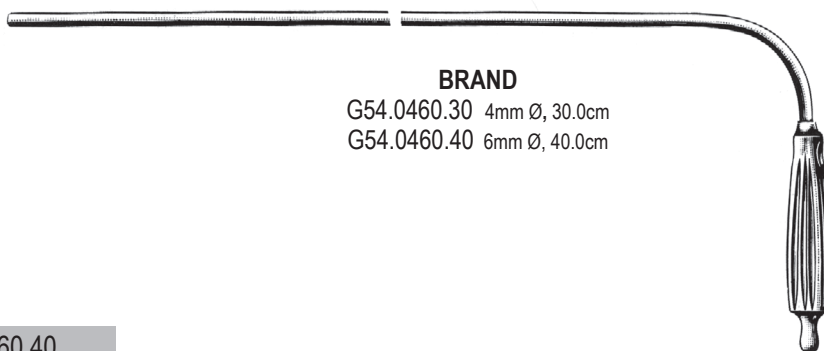

BRAND
G54.0460.30 4mm Ø, 30.0cm
G54.0460.40 6mm Ø, 40.0cm

G54-012 G54.0460.40

