

- **Medical Equipment**
- **Surgical instruments**

Darm und Magen

DE	Darm und Magen
EN	Intestinal and Stomach
ES	Intestinal y estómago
AR	الأمعاء والمعدة

G52

PAGE 001 to 019



DE Gewebe und Darmklemmen
EN Tissue and Intestinal Forceps
ES Pinzas para tejido y intestinales
AR الأنسجة والملقط المعوية



ALLIS-BABY
G52.0010.12 12.0cm
4:5 teeth



ALLIS
4:5 teeth 5:6 teeth
G52.0020.15 15.0cm G52.0022.15
G52.0020.19 19.0cm G52.0022.19
G52.0020.22 22.0cm G52.0022.22
G52.0020.25 25.0cm G52.0022.25



BOYS-ALLIS
G52.0030.15 15.0cm

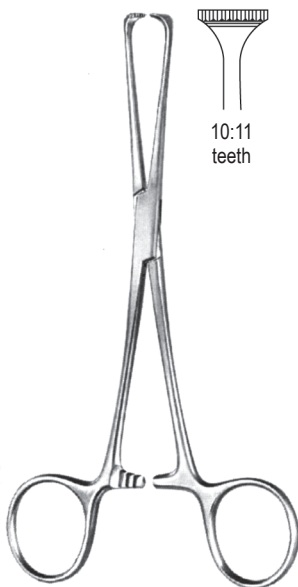

ALLIS-ADAIR
G52.0040.15 15.5cm

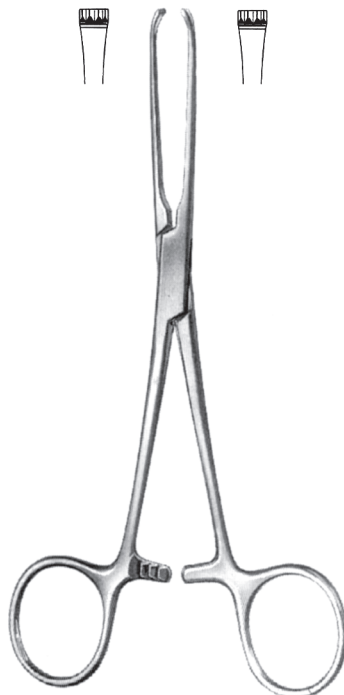

JUDD-ALLIS
G52.0050.15 15.0cm
G52.0050.19 19.0cm



ALLIS-ATRAUMA

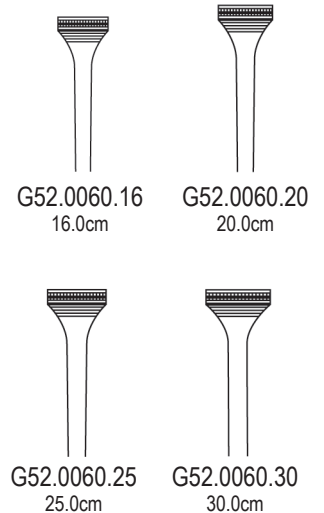

G52.0060.30 **G52-001**





THOMS-ALLIS
G52.0070.20 20.0cm



ALLIS
G52.0080.20 20.0cm

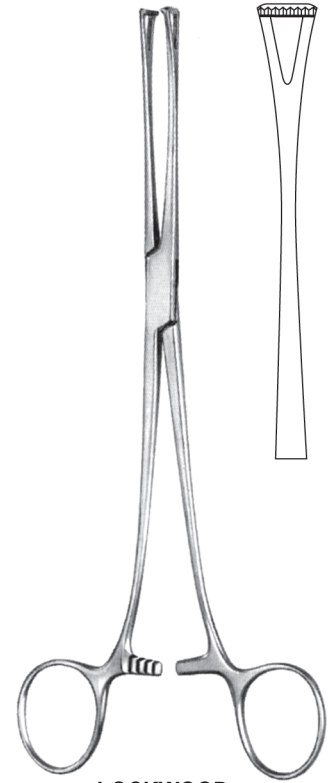

LOCKWOOD
G52.0090.20 20.0cm

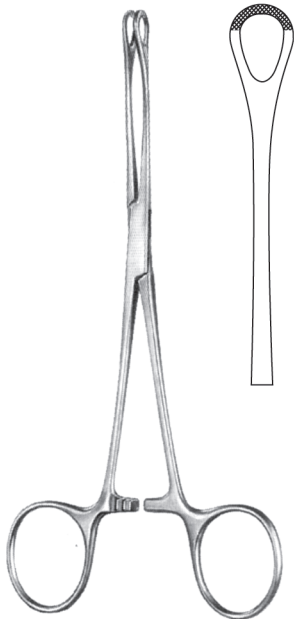

WILLIAMS
G52.0100.16 16.0cm

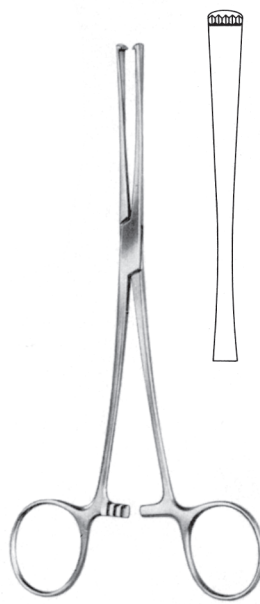

LOCKWOOD-ALLIS
G52.0110.16 16.0cm
G52.0110.20 20.0cm

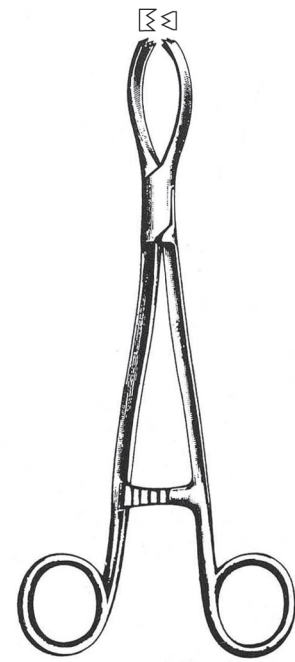

LITTLEWOOD
G52.0120.19 19.0cm



DE Gewebe und Darmklemmen
EN Tissue and Intestinal Forceps
ES Pinzas para tejido y intestinales
AR الأنسجة والملقط المعوية

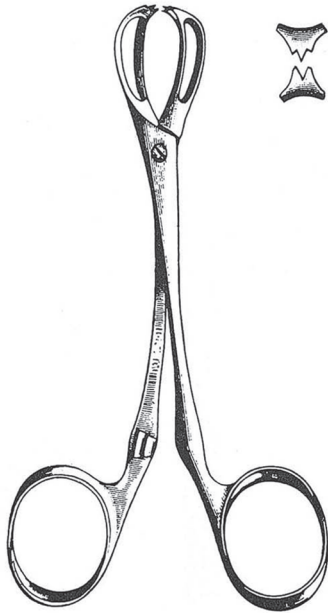

LANE
G52.0130.12 12.5cm
G52.0130.15 15.0cm
G52.0130.19 19.0cm

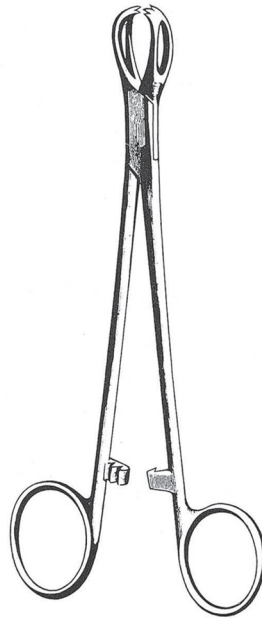

LANE
G52.0134.12 12.5cm
G52.0134.15 15.0cm
G52.0134.19 19.0cm

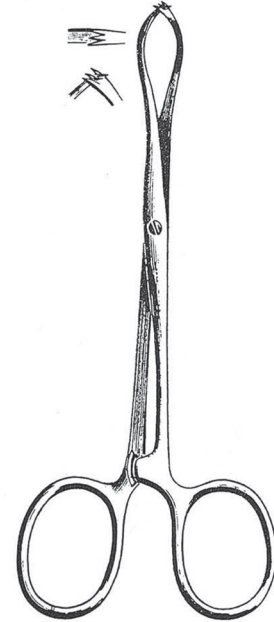

PORRIER
G52.0140.12 12.5cm
G52.0140.18 18.0cm

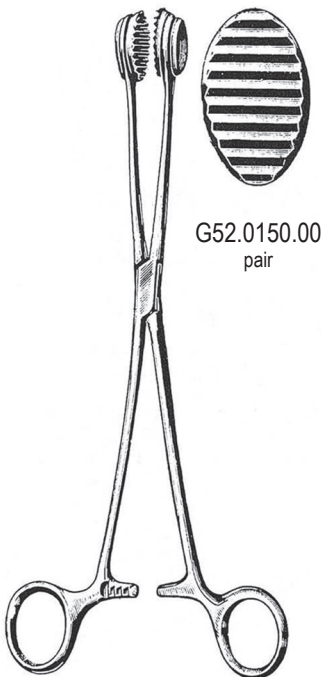

CHILDS
G52.0150.24 24.0cm

G52.0150.00
pair

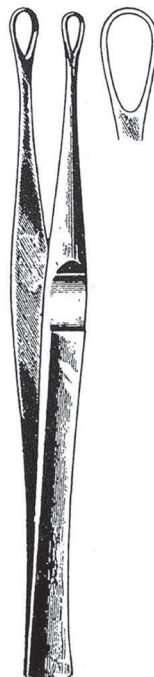

DENIS-BROWNE
G52.0160.18 18.0cm

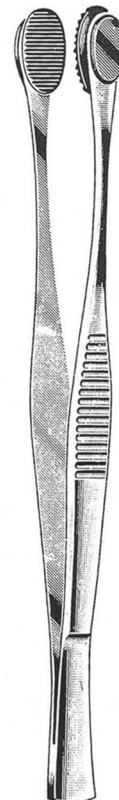

YOUNG
G52.0170.21 21.0cm

G52.0170.21 **G52-003**



Darmklemmen DE

Intestinal Forceps EN

Pinzas intestinales ES

الملقط المعوية AR



BABCOCK

- G52.0180.16 16.0cm
- G52.0180.18 18.0cm
- G52.0180.20 20.0cm
- G52.0180.24 24.0cm



BABCOCK

- G52.0182.16 16.0cm
- G52.0182.18 18.0cm
- G52.0182.20 20.0cm
- G52.0182.24 24.0cm



BABCOCK-ATRAUMA

- G52.0184.16 16.0cm
- G52.0184.20 20.0cm

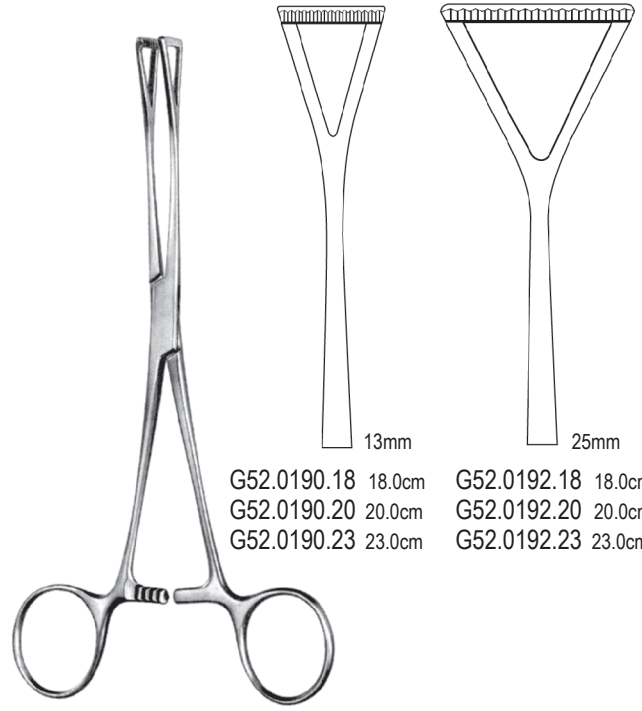

DUVAL

- G52.0190.18 18.0cm
- G52.0190.20 20.0cm
- G52.0190.23 23.0cm
- G52.0192.18 18.0cm
- G52.0192.20 20.0cm
- G52.0192.23 23.0cm



DE Darmklemmen
EN Intestinal Clamp Forceps
ES Pinzas-clamps intestinales
AR الملقط المشابك المعوية

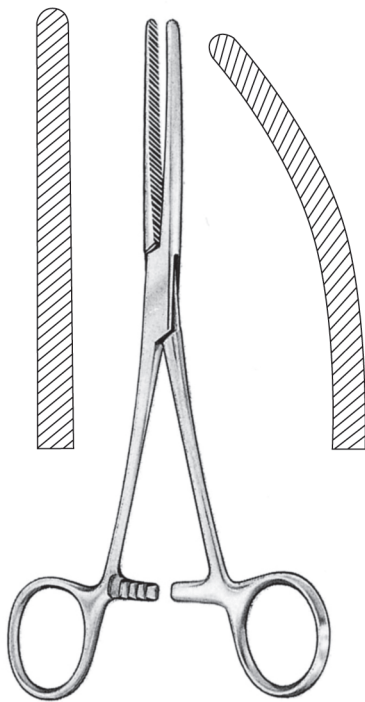

BABY-DOYEN

G52.0200.18 18.0cm G52.0201.18

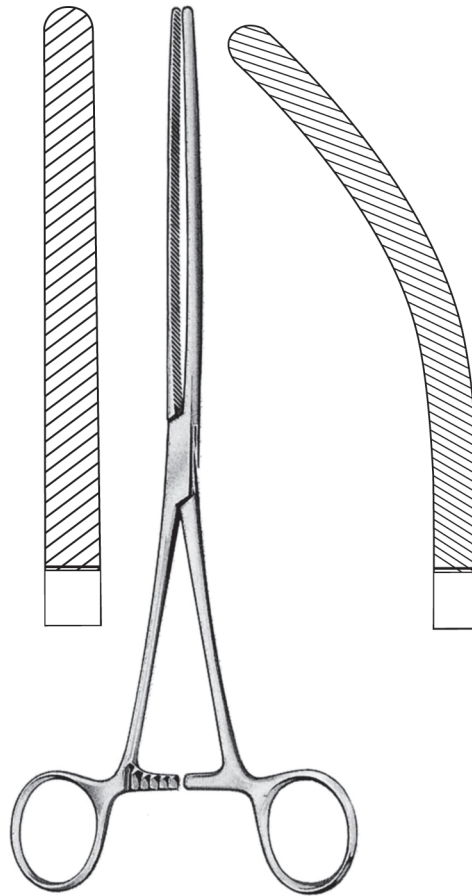

DOYEN

G52.0204.21 21.0cm G52.0205.21
G52.0204.23 23.0cm G52.0205.23

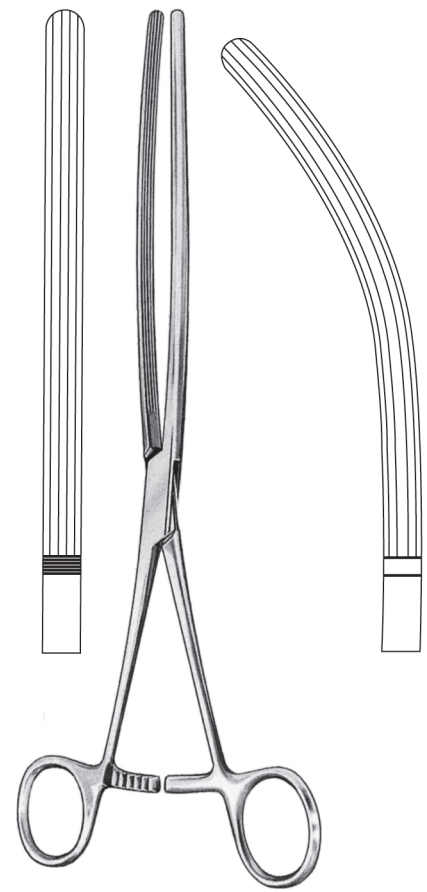

MAYO-ROBSON

G52.0210.21 21.0cm G52.0211.21
G52.0210.23 23.0cm G52.0211.23
G52.0210.25 25.0cm G52.0211.25

G52.0211.25 **G52-005**



G52

Darmklemmen, Blinddarmklemme DE
Intestinal Intestinal and Appendix Clamps Forceps EN
Pinzas-clamps intestinales y para apendice ES
الملقط المشابك المعوية والزائدة الدودية AR

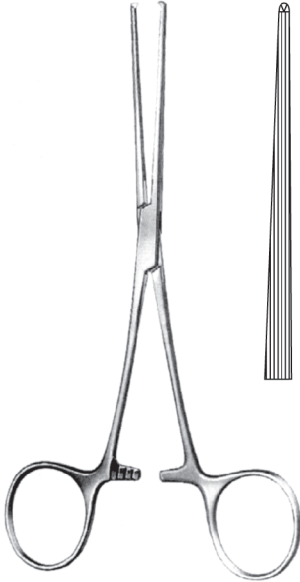

ALLEN
G52.0220.15 15.5cm

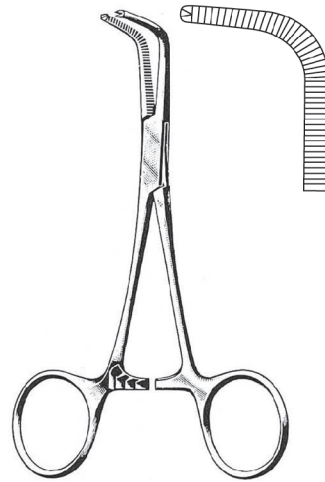

KLEINSCHMIDT
G52.0230.12 12.0cm

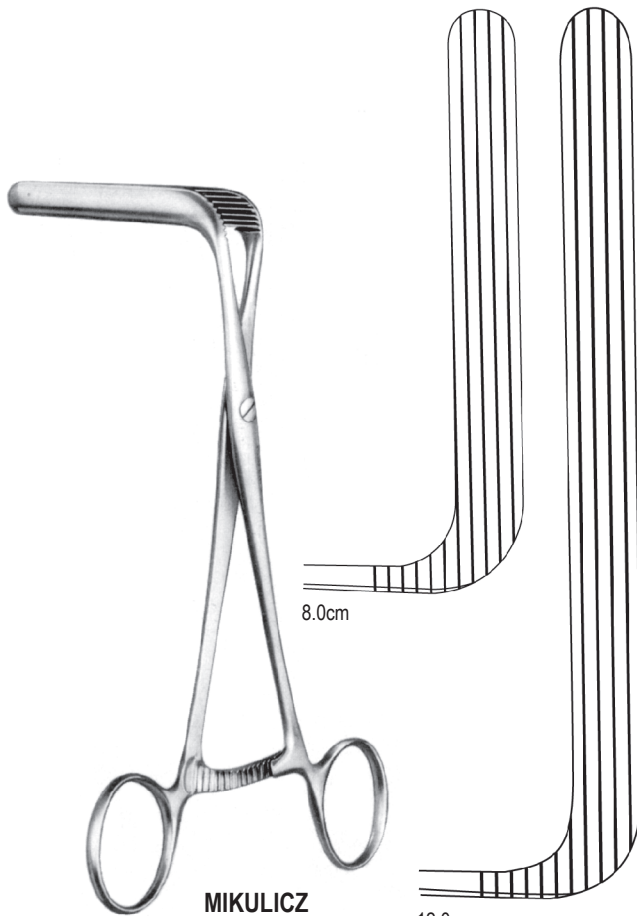

MIKULICZ
G52.0240.08 8.0cm
G52.0240.12 12.0cm

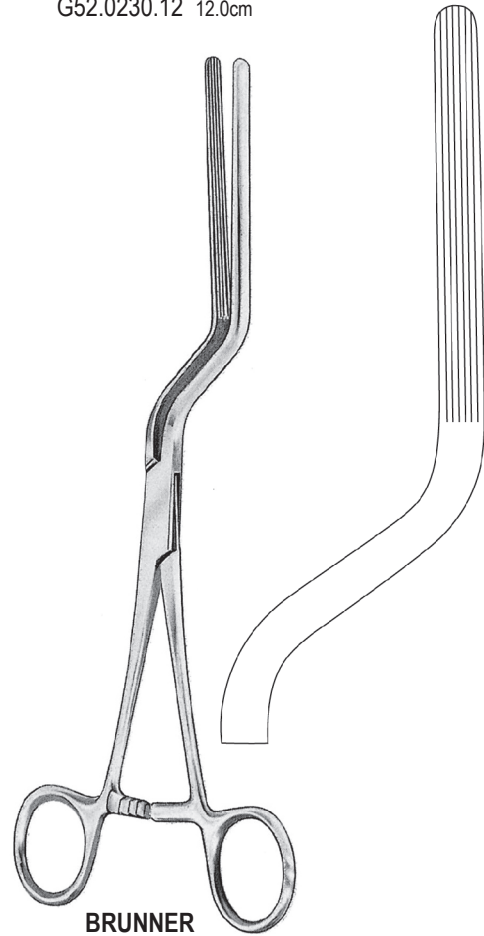

BRUNNER
G52.0250.24 24.0cm

G52-006 G52.0250.24



DE Darmklemmen
EN Intestinal Clamp Forceps
ES Pinzas-clamps intestinales
AR الملقط المشابك المعوية

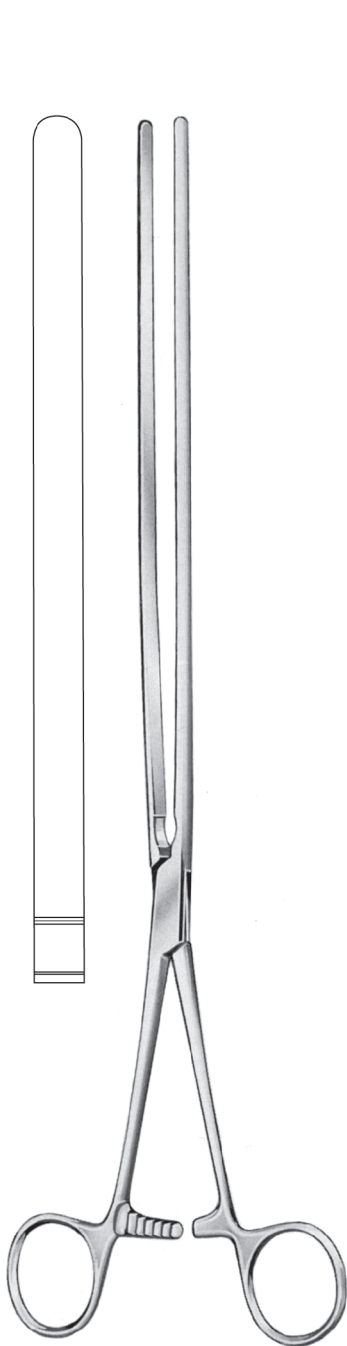

SCUDDER
G52.0260.25 25.0cm G52.0261.25
G52.0260.33 33.0cm G52.0261.33

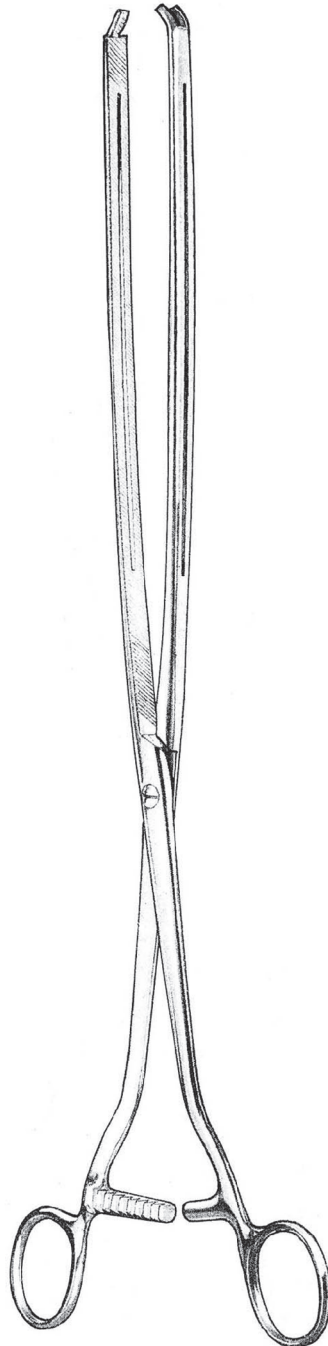

MOYNIHAN
G52.0270.36 36.0cm G52.0271.36

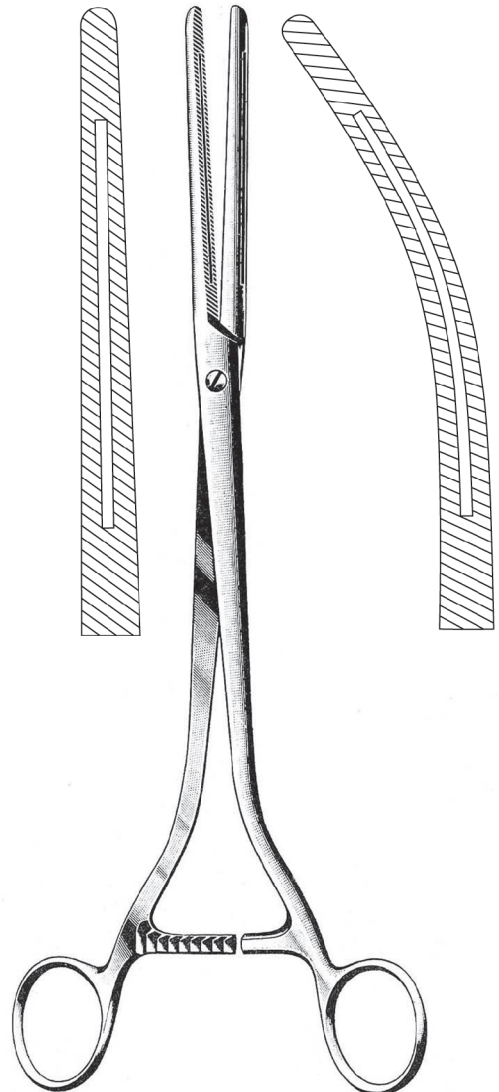

MOYNIHAN
G52.0280.29 29.0cm G52.0281.29



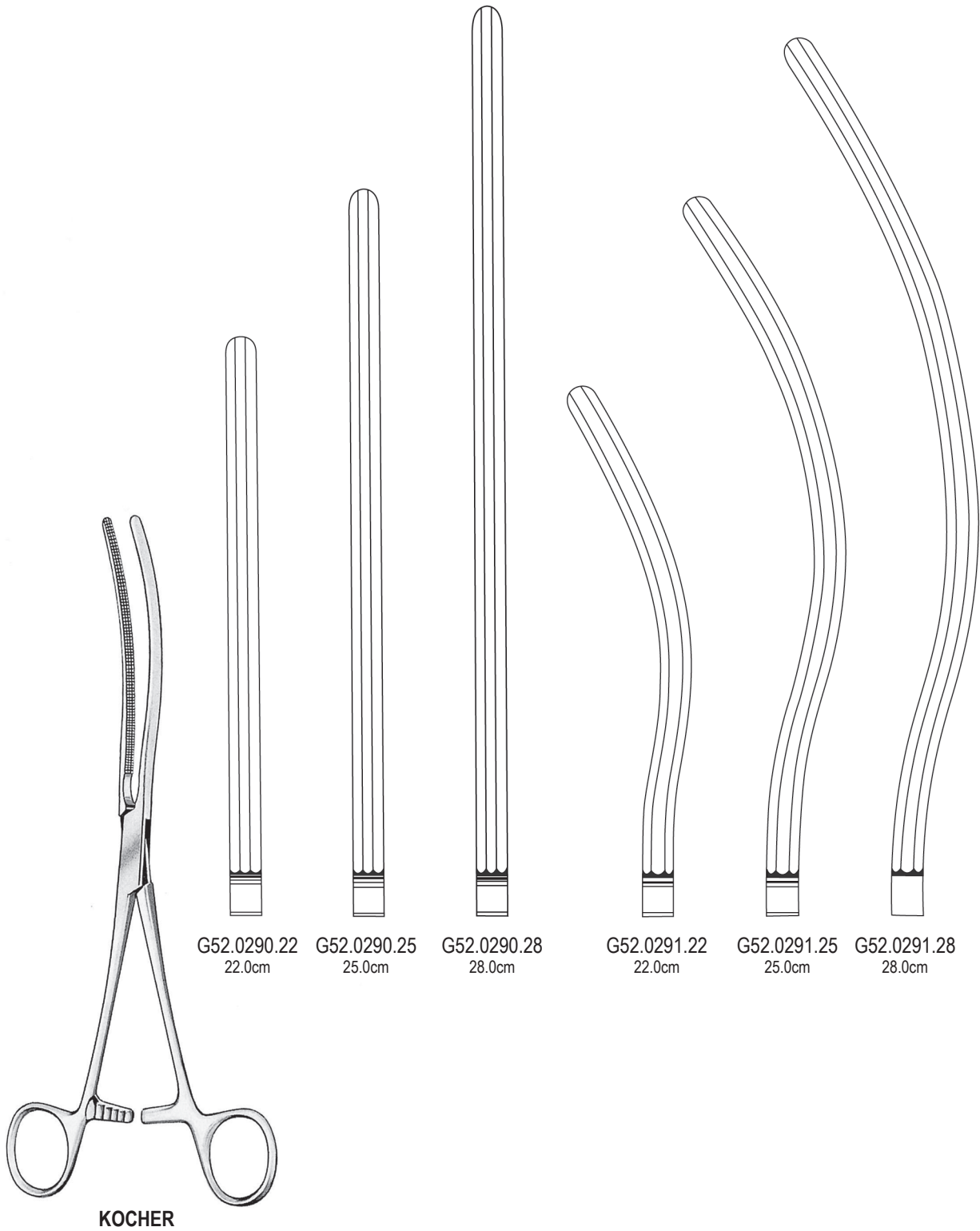

DE Atrauma-Darm-und Magenklappen
 EN Atrauma Intestinal and Stomach Clamps
 ES Atrauma pinzas clamps intestinales y estomacales
 AR المشابك المعوية والمعدة لاراضي

ATRAUMA



DOYEN-ATRAUMA



G52.0300.16
16.0cm



G52.0300.18
18.0cm



G52.0300.21
21.0cm



G52.0300.23
23.0cm

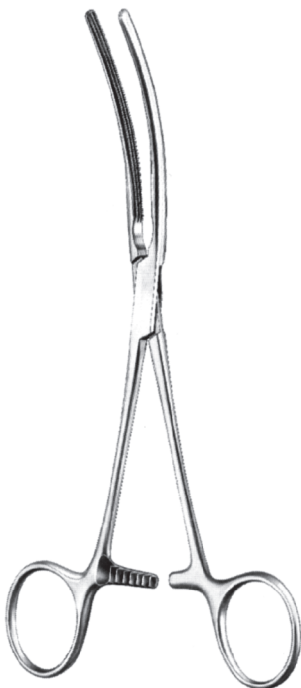

DOYEN-ATRAUMA

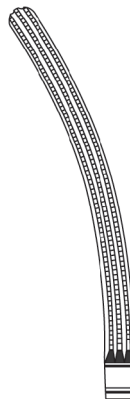

G52.0301.16
16.0cm

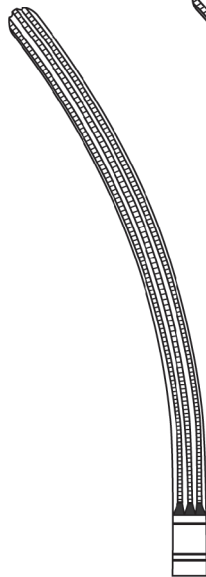

G52.0301.18
18.0cm

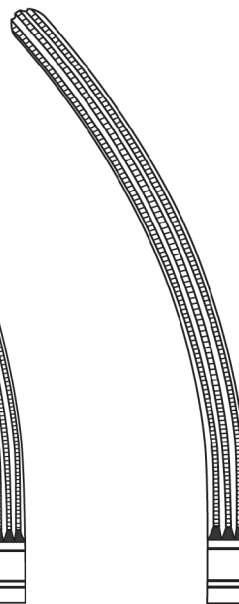

G52.0301.21
21.0cm

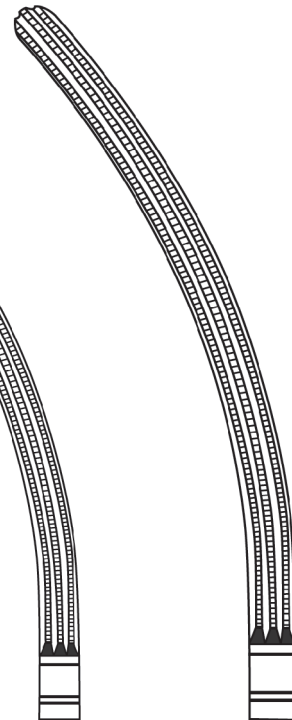

G52.0301.23
23.0cm

G52.0301.23 **G52-009**



Atrauma-Darm-und Magenklammern DE

Atrauma Intestinal and Stomach Clamps EN

Atrauma pinzas clamps intestinales y estomacales ES

المشابك المعوية والمعدة لاراضي AR

ATRAUMA



KOCHER-ATRAUMA

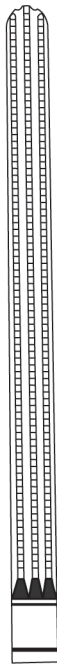

G52.0310.22
22.0cm

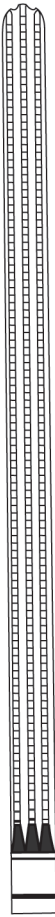

G52.0310.25
25.0cm

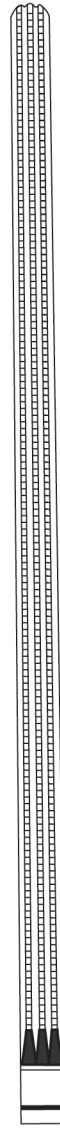

G52.0310.28
28.0cm

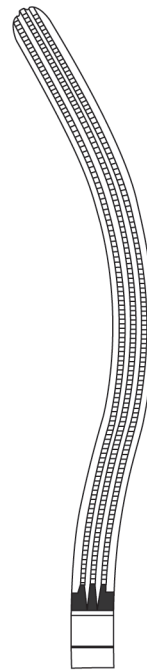

G52.0311.22
22.0cm

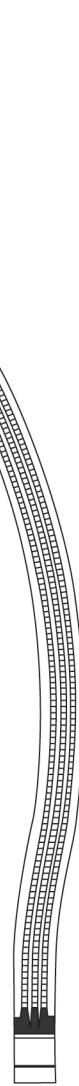

G52.0311.25
25.0cm

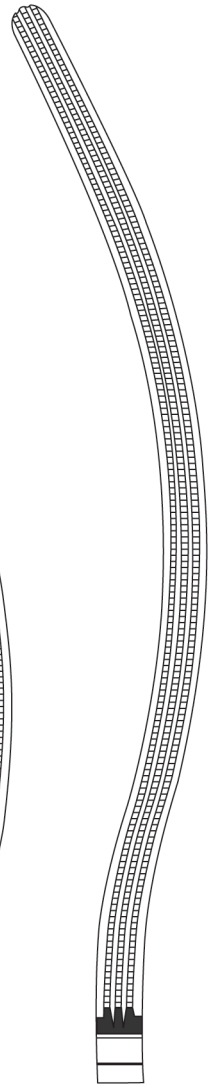

G52.0311.28
28.0cm



- DE Atrauma-Darm-und Magenklappen
- EN Atrauma Intestinal and Stomach Clamps
- ES Atrauma pinzas clamps intestinales y estomacales
- AR المشابك المعوية والمعدة لاراضي

ATRAUMA



MAYO-ROBSON-ATRAUMA
G52.0320.25 25.0cm

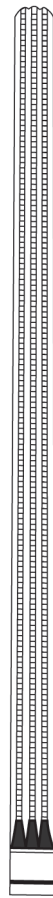

MAYO-ROBSON-ATRAUMA
G52.0321.25 25.0cm



ATRAUMA

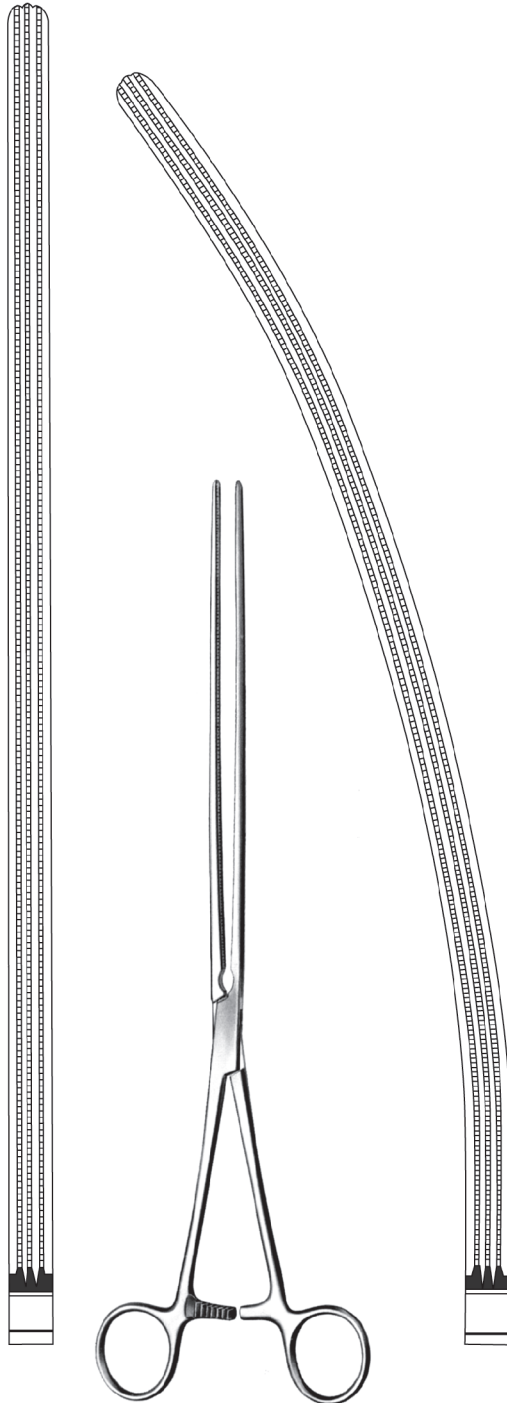

SCUDDER
G52.0330.33 33.0cm G52.0331.33

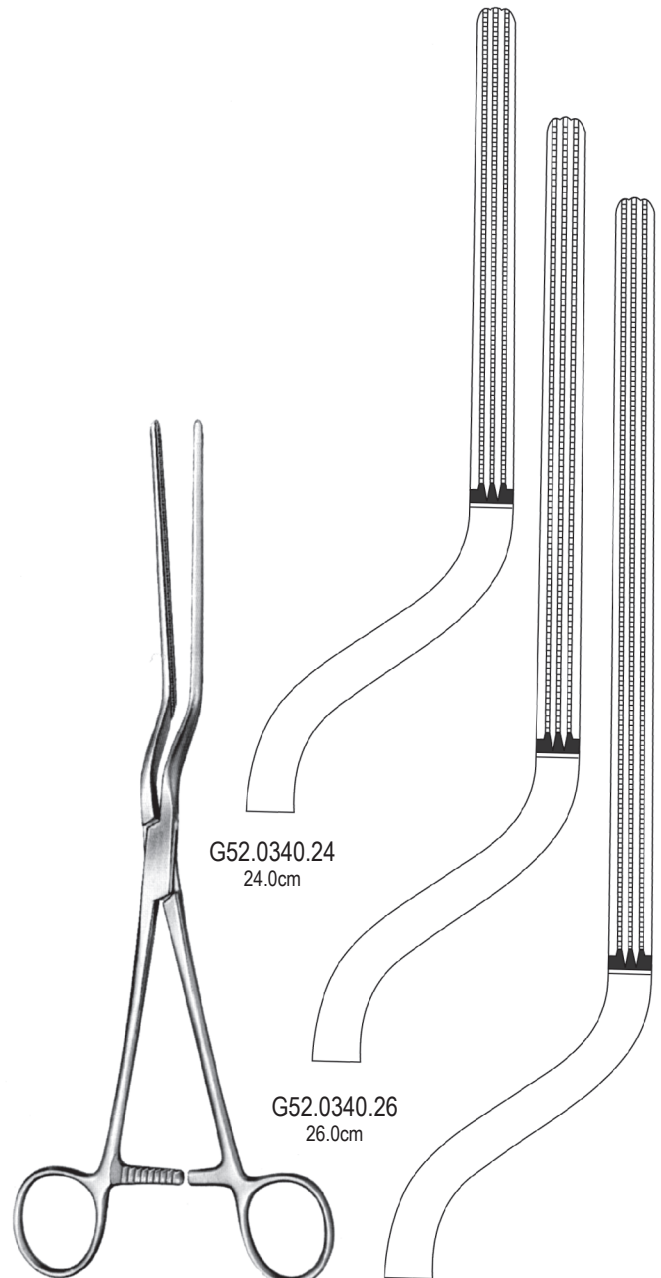

G52.0340.24
24.0cm

G52.0340.26
26.0cm

BRUNNER

G52.0340.28
28.0cm



- DE **Atrauma Rektum-Anastomosenklemmen**
- EN **Atrauma Sigmoid Anastomosis Forceps**
- ES **Atrauma pinzas para anastomosis del recto**
- AR **الاستيطاني الملقط التحام السيني**

ATRAUMA

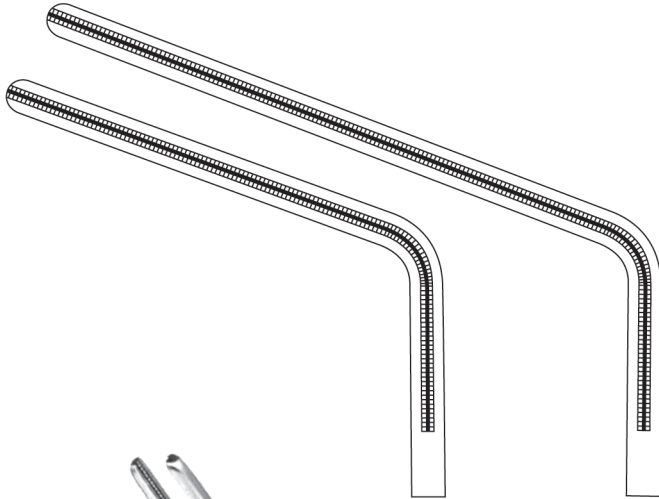

G52.0350.26 26.0cm G52.0350.28 28.0cm

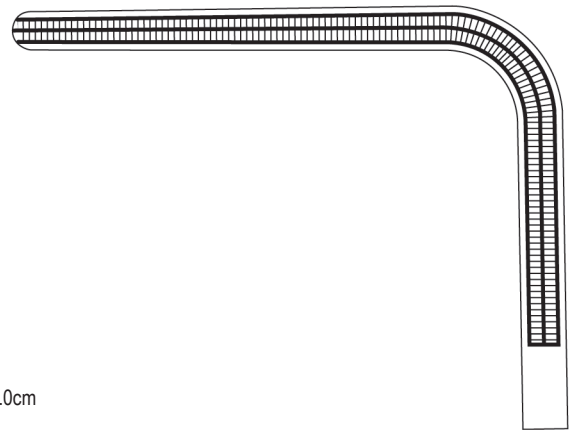

HAYES



VEIDENHEIMER
G52.0360.23 23.0cm

G52.0360.23 **G52-013**



Atrauma Rektum-Anastomosenklemmen DE

Atrauma Sigmoid Anastomosis Forceps EN

Atrauma pinzas para anastomosis del recto ES

الاستيطاني الملقط التحام السيني AR

ATRAUMA



RESANO
G52.0364.30 30.0cm



FEHLAND
G52.0370.24 24.0cm

G52-014 G52.0370.24



DE Darm-und Magenklappen
EN Intestinal and Stomach Clamps
ES Pinzas-clamps intestinales y estomacales
AR المشابك المعوية والمعدة

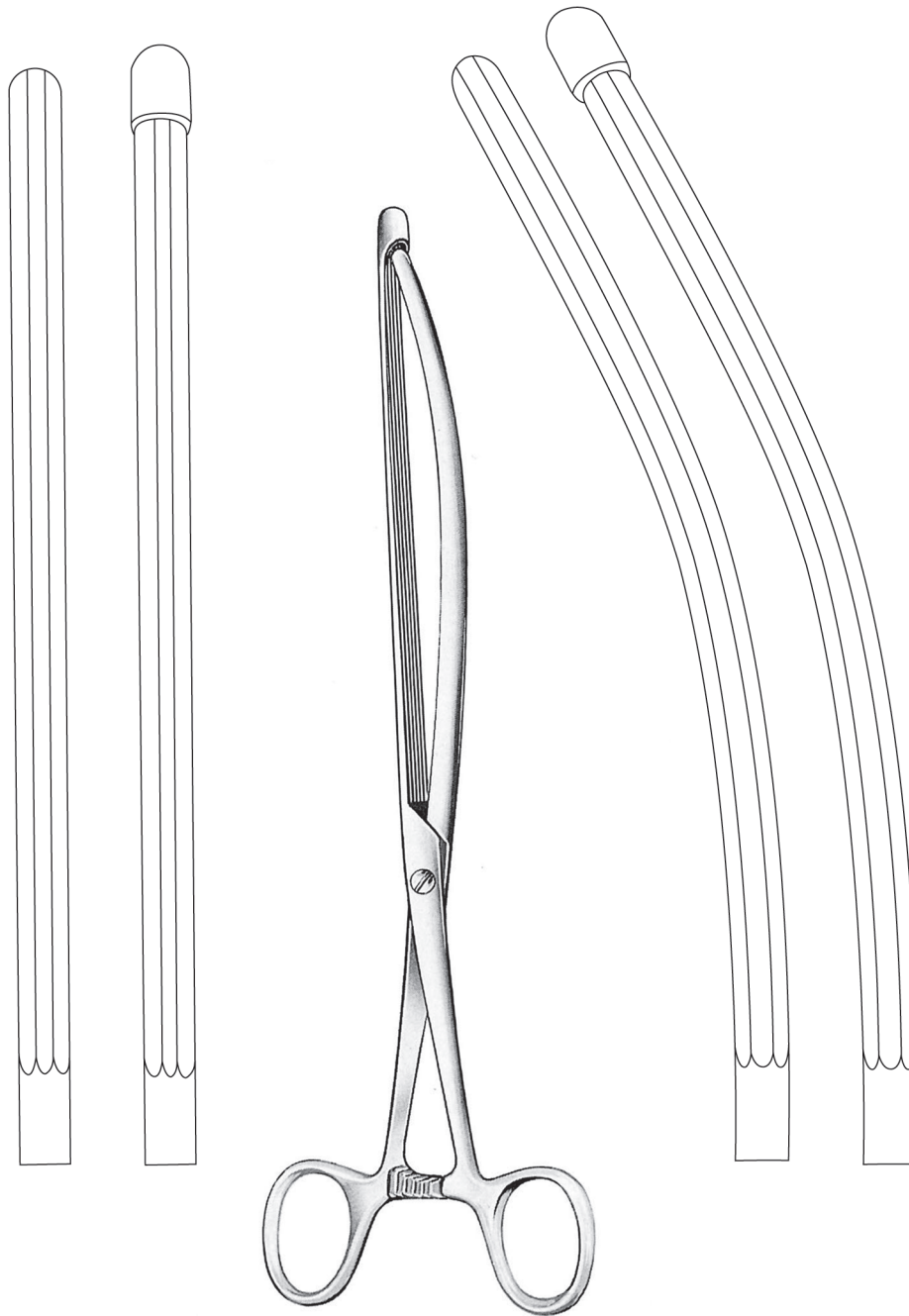

NUSSBAUM

G52.0380.25 25.0cm G52.0381.25
G52.0380.30 30.0cm G52.0381.30

G52.0381.30 **G52-015**



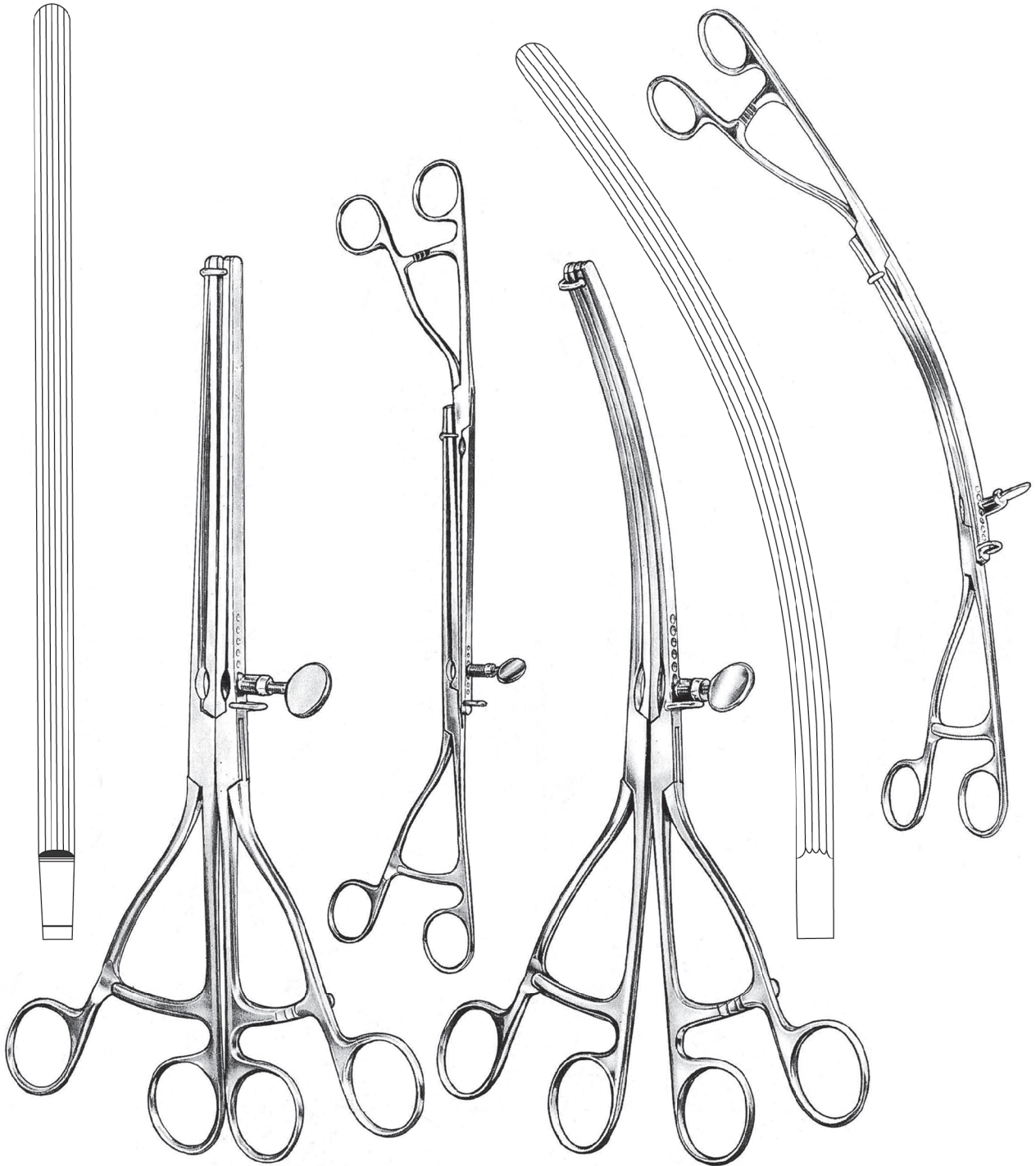

LANE
G52.0390.30 30.0cm

LANE
G52.0391.30 30.0cm

DE Darm-und Magenklappen
EN Intestinal and Stomach Clamps
ES Pinzas-clamps intestinales y estomacales
AR المشابك المعوية والمعدة



ROOSEVELT
G52.0400.34 34.0cm



HABERER
G52.0410.36 36.0cm

G52.0410.36 **G52-017**





PAYR-BABY
G52.0420.15 15.0cm



PAYR
G52.0420.21 21.0cm



PAYR
G52.0420.29 29.0cm



PAYR
G52.0420.35 35.0cm



DE Darmklemmen, Anastomosenklemmen
 EN Intestinal and Anastomosis Clamps Forceps
 ES Pinzas-clamps intestinales y para anastomosis
 AR المعوية والتحام المشابك الملقط



STONE
G52.0430.15 15.5cm

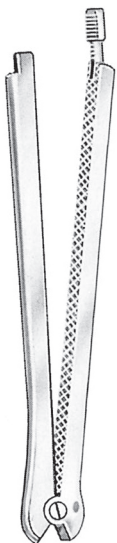

DE MARTEL-WOLFSON
G52.0440.05 5.0cm
G52.0440.07 7.0cm
G52.0440.10 10.0cm

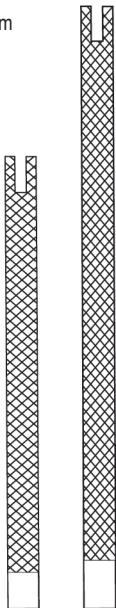

STONE-WATT
G52.0432.00



G52.0434.08 8.5cm



STONE-WATT
G52.0436.07 7.5cm
G52.0436.10 10.0cm



DE MARTEL-WOLFSON
G52.0444.23 23.0cm

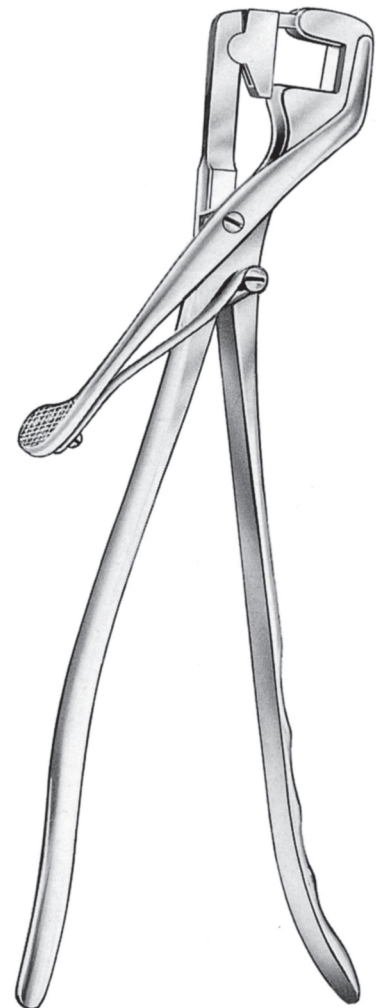

DE MARTEL-WOLFSON
G52.0450.26 26.0cm





www.gsi-medical.de