

- **Medical Equipment**
- **Surgical instruments**

## Tonsillen

DE	Tonsillen
EN	Tonsil
ES	Amigdala
AR	لوزة الحلق

**G50**

PAGE 001 to 015



DE Tonsillennadeln

EN Tonsil Needles

ES Agujas para suturas de amígdalas

AR الإبر لوزة



**HURD**  
G50.0010.21 21.0cm G50.0012.21

**DURHAM**  
G50.0020.25 25.0cm G50.0022.25

**ROTTER**  
G50.0030.26 26.0cm G50.0032.26

G50.0032.26 **G50-001**

# G50

Tonsillennadeln DE

Tonsil Needles EN

Agujas para suturas de amígdalas ES

الإبر لوزة AR



**NAGER**  
G50.0040.24 24.0cm

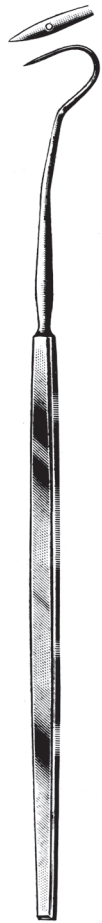

**CLAUS-EICKEN**  
G50.0046.23 23.0cm



**DUPUY-WEISS**  
G50.0050.22 22.0cm G50.0052.22

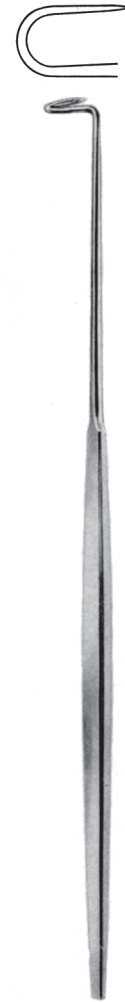

**FALK**  
G50.0060.24 24.0cm G50.0062.24



**G50-002** G50.0062.24



DE	Tonsillennmesser
EN	Tonsil Knives
ES	Bisturries
AR	السكاكين لوزة



**BRUENINGS**  
G50.0070.23 23.0cm



**ABRAHAM**  
G50.0074.21 21.0cm



**FISHER**  
G50.0080.22 22.5cm



**COLVER**  
G50.0084.22 22.5cm

G50.0084.22 **G50-003**





Tonsillennmesser und Dissektoren DE

Tonsil Knives and Dissector EN

Bisturios p / amígdalas y disecadores ES

السكاكين لوزة ومشرح AR

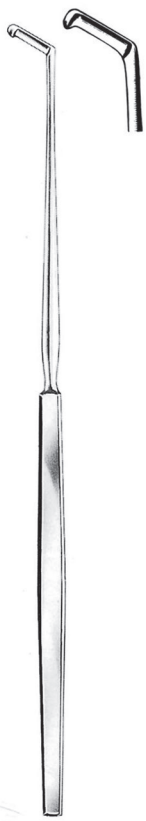

**DOUGLAS**

G50.0090.21 21.0cm



**CANFIELD**

G50.0094.21 21.0cm



**TYDING**

G50.0100.21 21.0cm



**LYNCH**

G50.0104.20 20.0cm



**DAY**

G50.0110.21 21.5cm

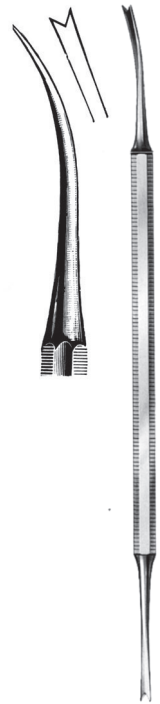

**LUNIATSCHEK**

50.0114.19 19.0cm



DE Tonsillenmesser, dissektoren, Enukleator, Retraktor usw.

EN Tonsil Knives, Dissectors, Enucleators, Retractor etc.

ES Bisturías, disecadores, enucleador, separador etc.

AR السكاكين لوزة استئصال اللوزتين واستئصال اللوزتين بالتسليخ



**HURD**  
G50.0120.22 22.5cm

**HENKE**  
G50.0124.23 23.0cm

**HENKE**  
G50.0130.23 23.0cm

**CARPENTER**  
G50.0134.25 25.0cm

**CARPENTER**  
G50.0140.24 24.0cm

Dissektoren, Enukleator, Retraktor usw. DE

Dissectores, Enucleator, Retractor etc. EN

Discadores, enucleador, separador etc. ES

مشرح، استأصل، المختنق الخ AR

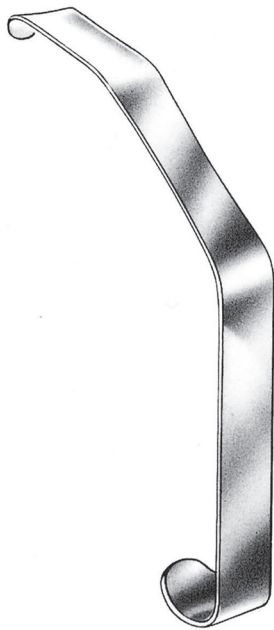

**LOVE**

15.0cm

G50.0150.18 18mm

G50.0150.20 20mm

G50.0150.22 22mm

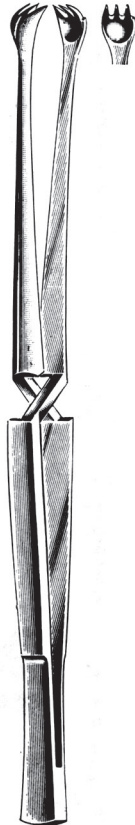

**MARSCHIK**

G50.0154.22 22.0cm



**NAGER**

G50.0160.24 24.0cm

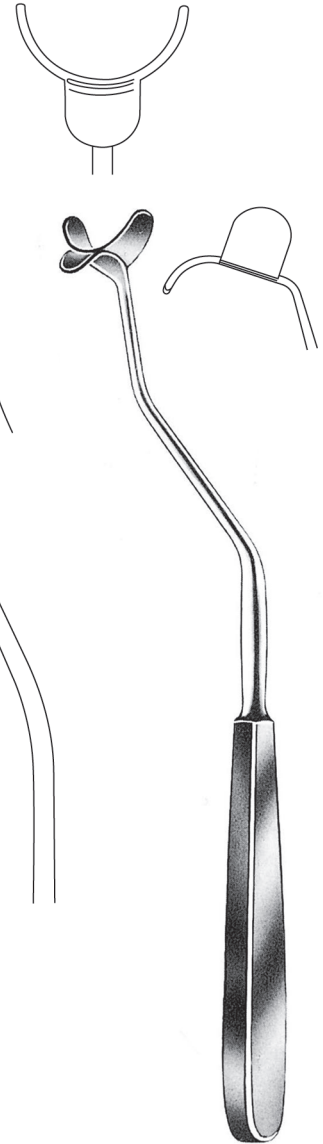

**HOFER**

G50.0164.24 24.0cm



DE Tonsillenzangen

EN Tonsil Seizing Forceps

ES Pinzas para coger las amígdalas

AR الملقط لوزة الاستيلاء على

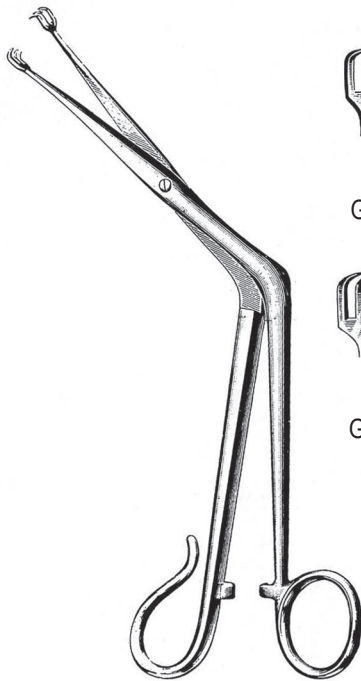

**TIVNEN-TYDING**  
21.0cm



Fig. 1

G50.0170.21

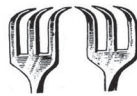
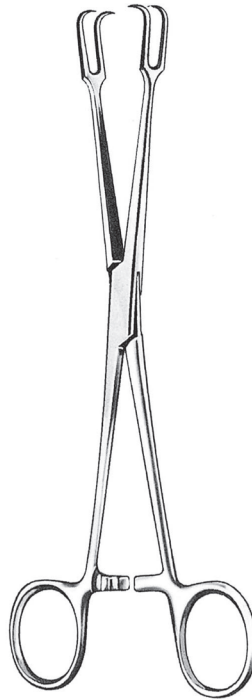
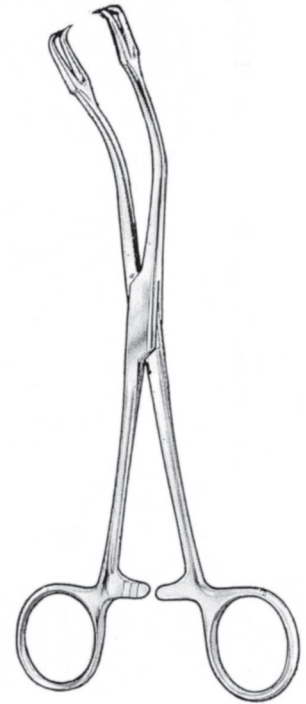

Fig. 2

G50.0172.21



**MUSEUX**  
G50.0180.20 20.0cm



**MUSEUX**  
G50.0181.20 20.0cm

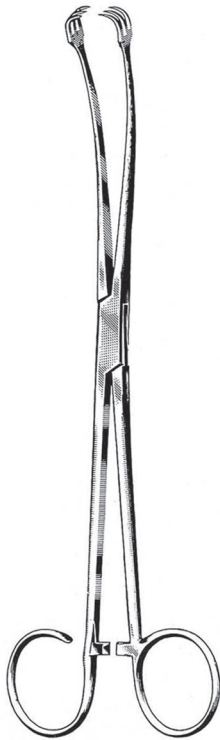

**BALLENGER**  
G50.0184.21 21.5cm



**WHITE**  
G50.0190.18 18.0cm  
G50.0190.23 23.0cm



G50.0194.19

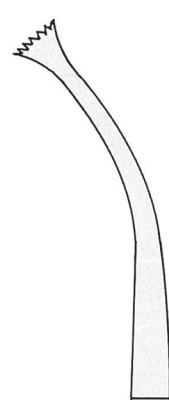

G50.0195.19

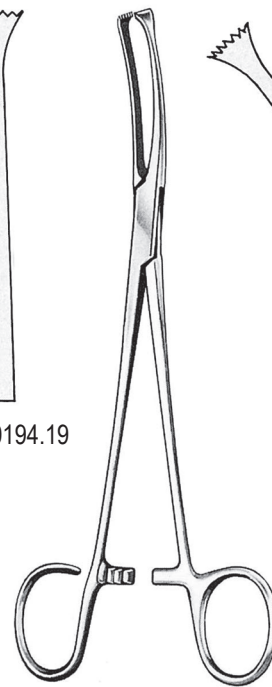

**COLVER**  
19.0cm

G50.0195.19 **G50-007**



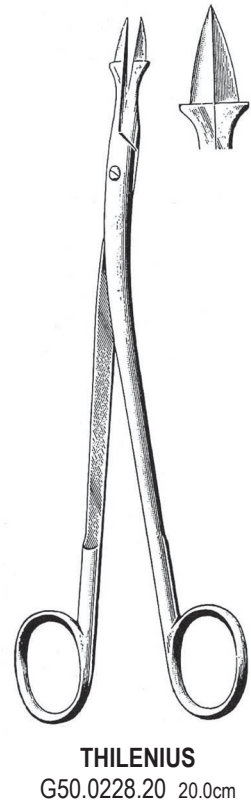
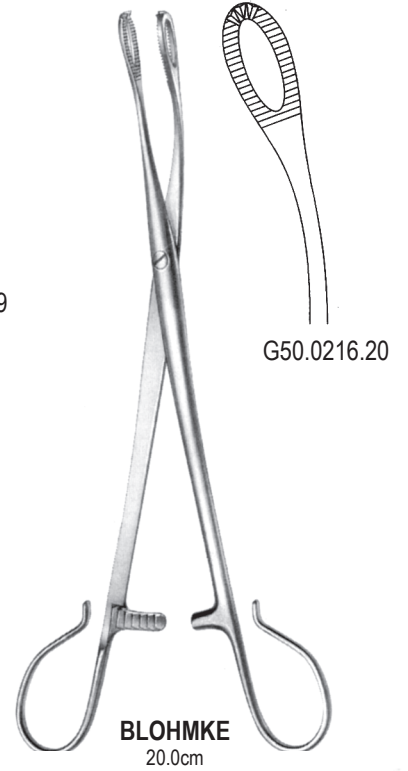
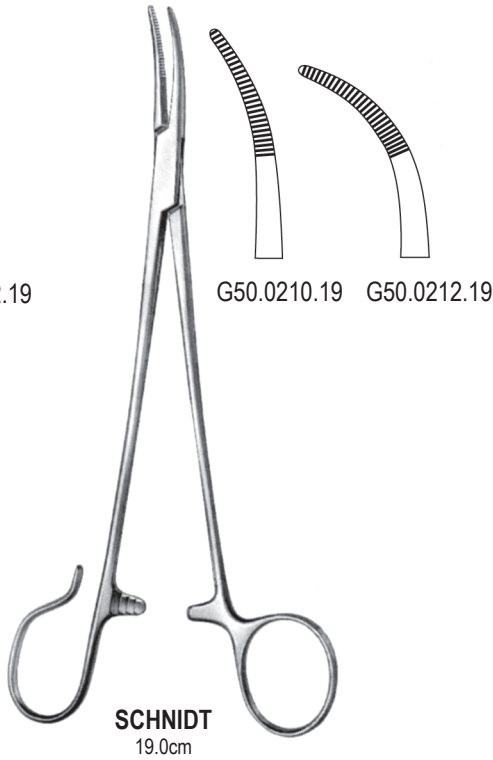
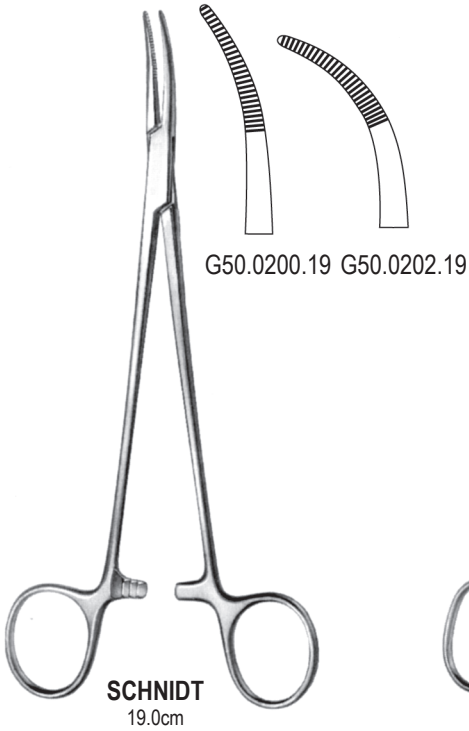

- DE Tonsil Haemostatic zange
- EN Tonsil Haemostatic Forceps
- ES Pinzas de amigdala haemostatic
- AR لوزة الحلق الملقط تخثر الدم



**NEGUS**  
19.0cm

G50.0230.19



G50.0232.19

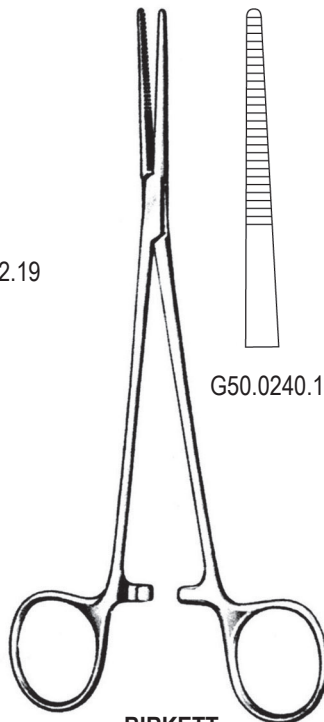

**BIRKETT**  
19.0cm

G50.0240.19



G50.0241.19

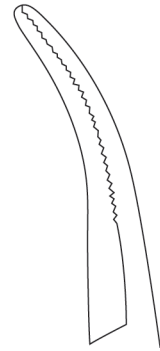

G50.0243.19

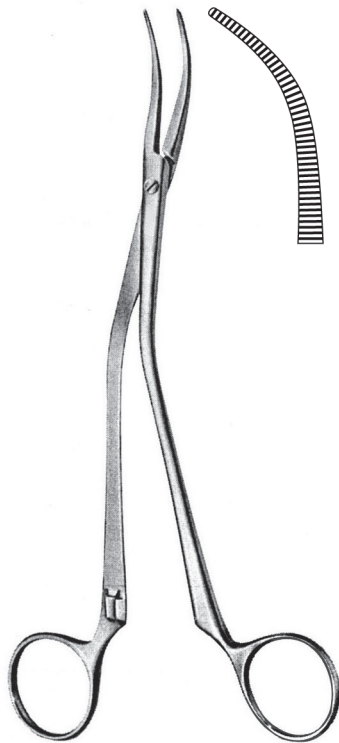

**WILSON**  
G50.0250.19 19.0cm



**MOLLISON**  
G50.0254.18 18.0cm (with horizontal opening)  
G50.0256.18 18.0cm (with vertical opening)

G50.0256.18 **G50-009**





Tonsillenschnürer DE  
Tonsil Snares EN  
Cierra-nudos para amígdalas ES  
الافخاخ لوزة AR



**EYES**  
G50.0260.28 28.0cm



**EYES**  
G50.0270.28 28.0cm

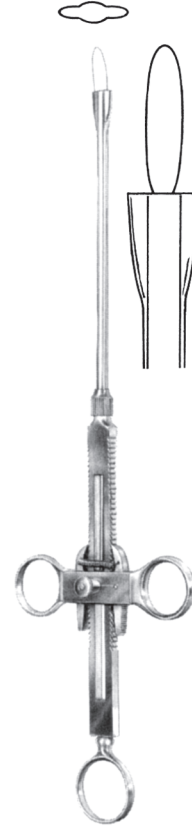

**BRUENINGS**  
G50.0280.28 28.0cm

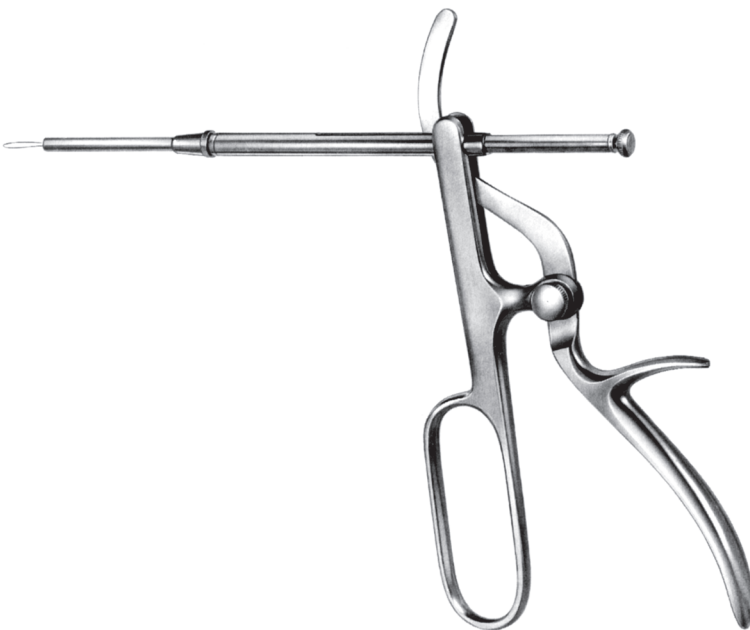

**TYDING**  
G50.0290.00

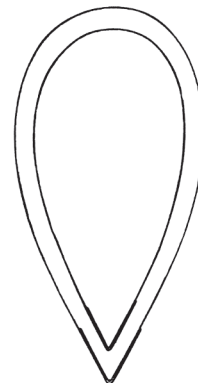

G50.0300.40 40mm  
G50.0300.50 50mm



G50.0306.03 0.3mm Ø

**G50-010** G50.0306.03



DE Tonsillotome  
EN Tonsillectomes  
ES Amigdalotomos  
AR إستئصال اللوزتين

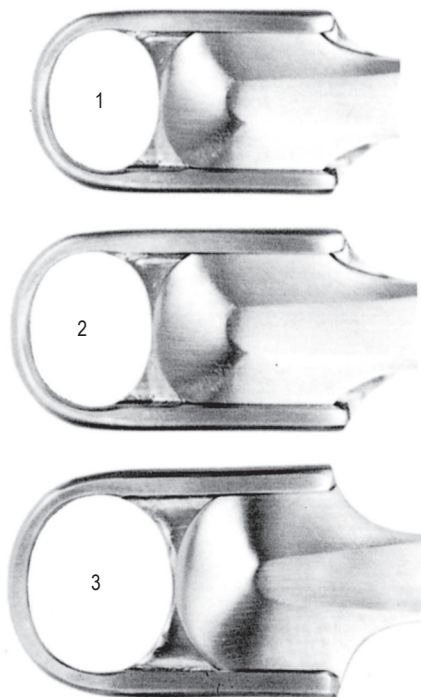
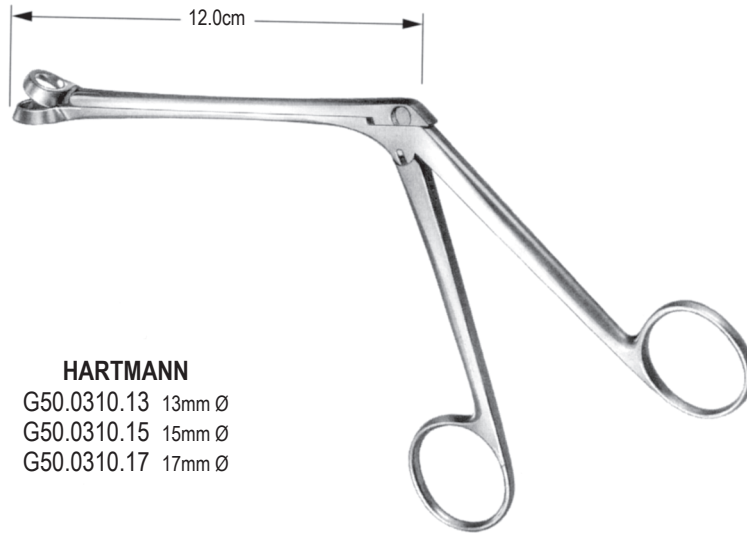

**SLUDER-BALLENGER**  
G50.0320.00 compl.  
3-tips  
G50.0320.01  
G50.0320.02  
G50.0320.03

G50.0320.03 **G50-011**



Universalgriffe und Veriangerungsröhre, Broncho-Oesophagoskopiezangen **DE**  
 Universal Handles and Interchangeable Tubes, Broncho-Esophagoscopy Forceps **EN**  
 Mangos universales y tubos de extension, pinzas para bronco-esofagoscopia **ES**

عالمي مقابض وأنايب قابلة للتبديل، الملقط الشعبة الهوائية تنظير المريء **AR**

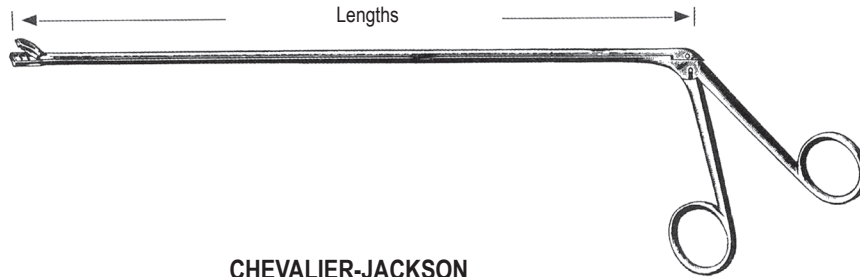

**CHEVALIER-JACKSON**



30.0cm	G50.0331.30	G50.0332.30	G50.0333.30	G50.0334.30	G50.0335.30	G50.0336.30	G50.0337.30
40.0cm	G50.0331.40	G50.0332.40	G50.0333.40	G50.0334.40	G50.0335.40	G50.0336.40	G50.0337.40
50.0cm	G50.0331.50	G50.0332.50	G50.0333.50	G50.0334.50	G50.0335.50	G50.0336.50	G50.0337.50
60.0cm	G50.0331.60	G50.0332.60	G50.0333.60	G50.0334.60	G50.0335.60	G50.0336.60	G50.0337.60



**HUBER**  
G50.0340.00



**BRUENINGS (straight)**

G50.0344.20	20.0cm
G50.0344.30	30.0cm
G50.0344.40	40.0cm
G50.0344.50	50.0cm
G50.0344.60	60.0cm

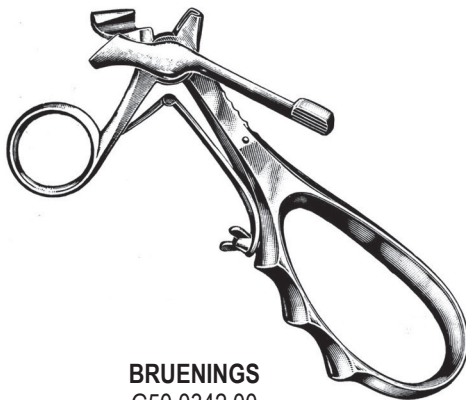

**BRUENINGS**  
G50.0342.00

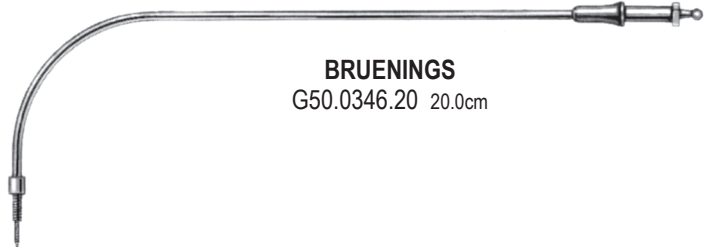

**BRUENINGS**  
G50.0346.20 20.0cm

**G50-012** G50.0346.20



DE **Auswechselbare Zangenaufsätze**  
 EN **Cutting and Grasping Forceps Tips**  
 ES **Pinzas intercambiables**  
 AR **قطع واستيعاب ذروة الملقط**

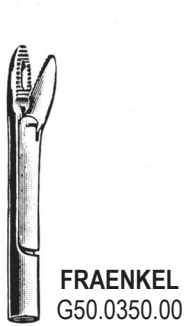

**FRAENKEL**  
G50.0350.00

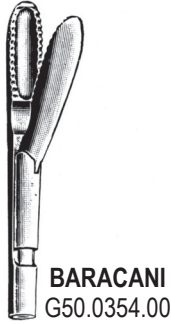

**BARACANI**  
G50.0354.00

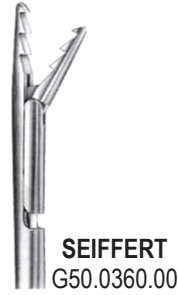

**SEIFFERT**  
G50.0360.00



**FRAENKEL**  
G50.0364.00

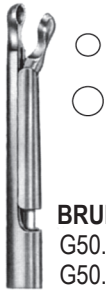

**BRUENINGS**  
G50.0370.01  
G50.0370.02

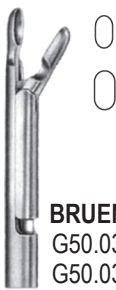

**BRUENINGS**  
G50.0374.01  
G50.0374.02



**LANGE**  
G50.0380.00



**KRAUSE**  
G50.0384.01  
G50.0384.02



**SCHUMACHER**  
G50.0390.00

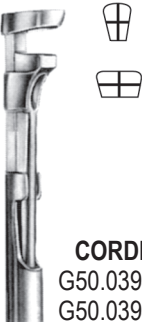

**CORDES**  
G50.0394.01  
G50.0394.02



**CORDES**  
G50.0400.00



**ROSENBERG**  
G50.0404.00



**KRAUSE**  
G50.0410.00

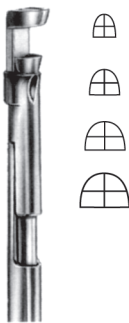

**CORDES**  
G50.0414.01  
G50.0414.02  
G50.0414.03  
G50.0414.04



**SCHEINMANN**  
G50.0420.00



**SCHEINMANN**  
G50.0424.00



# G50

Laryngeal Behandelt und Spiegelt wider **DE**  
 Laryngeal Handles and Mirrors **EN**  
 Los maneja y espejos laríngeos **ES**  
 مقابض الحنجرة و مرآيا **AR**



G50.0430.11



G50.0434.10



G50.0440.11



G50.0444.12



G50.0450.00



**MICHEL**  
25.0cm



G50.0460.12



G50.0460.14



G50.0460.16



G50.0460.18



G50.0464.08

G50.0464.10

G50.0464.12

G50.0464.14

G50.0464.16

G50.0464.18

G50.0464.20

G50.0464.22

G50.0464.24

G50.0464.26

G50.0464.28

G50.0464.30

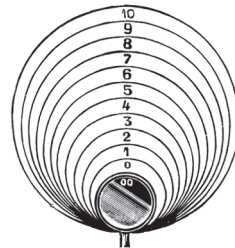

fig.00, 8mm Ø

fig.0, 10mm Ø

fig.1, 12mm Ø

fig.2, 14mm Ø

fig.3, 16mm Ø

fig.4, 18mm Ø

fig.5, 20mm Ø

fig.6, 22mm Ø

fig.7, 24mm Ø

fig.8, 26mm Ø

fig.9, 28mm Ø

fig.10, 30mm Ø



G50.0466.08

G50.0466.10

G50.0466.12

G50.0466.14

G50.0466.16

G50.0466.18

G50.0466.20

G50.0466.22

G50.0466.24

G50.0466.26

G50.0466.28

G50.0466.30

**G50-014** G50.0466.30

- DE Kehlkopfpolypenzangen, Deckelhalter, Tamponpinzetten  
 EN Laryngeal Polypus Forceps, Epiglottis Retractor, Tampon Forceps  
 ES Pinzas para polipos laringeos, depresor para epiglotis, pinzas para toponamientos  
 AR الزوائد اللحمية الحنجرة الملقط، هاة سحب لل، الحشا الملقط



G50.0470.01



G50.0470.02

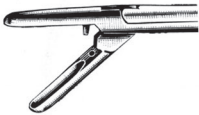

GF50.0470.03

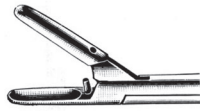

G50.0470.04



**JURASZ**  
23.0cm

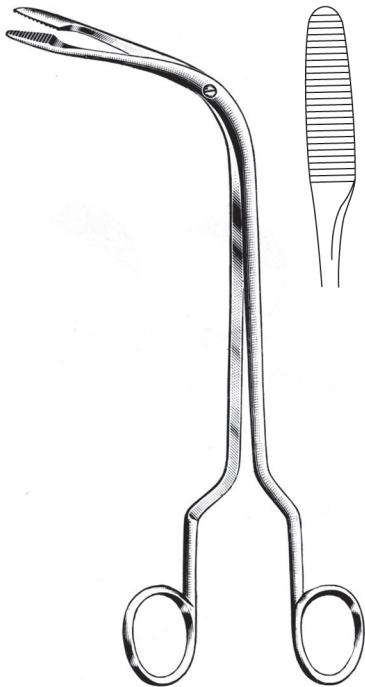

**FRAENKEL**  
G50.0474.19 19.0cm

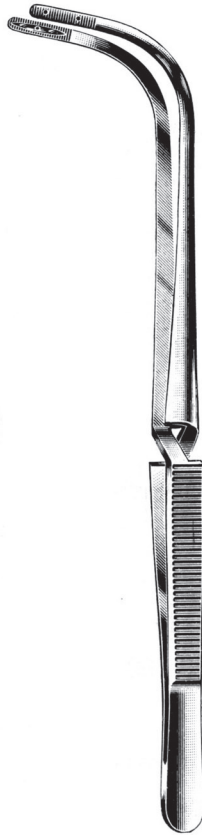

**JACKSON**  
22.0cm



G50.0480.22



G50.0482.22

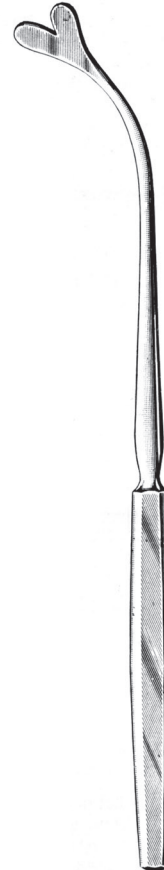

**REICHERT**  
G50.0486.24 24.0cm







[www.gsi-medical.de](http://www.gsi-medical.de)