

- **Medical Equipment**
- **Surgical instruments**

## Mündliche Instrumente

DE Mündliche Instrumente

EN Oral Instruments

ES Instrumentos orales

AR أدوات الفم

**G48**

PAGE 001 to 011



DE Serviettenhalter, Mundkeile, Fingerschutzet

EN Napkin Holders, Oral Wedges, Finger Protectors

ES Porta-servilletas, garrotes, dedales

AR أصحاب منديل، الأوتاد عن طريق الفم، وحماة فمجر



28 x 30 x 30 mm

**PITHA**  
G48.0010.02



G48.0012.00  
length adjustable



**ADAMS**  
G48.0014.00

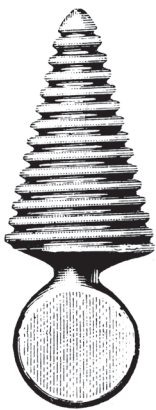

**MAUNDER**  
G48.0020.10

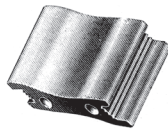

G48.0030.11

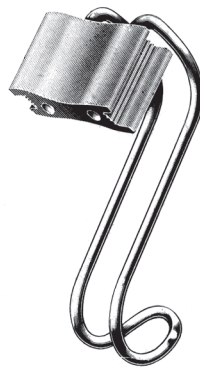

**PITHA**  
G48.0036.10



G48.0040.01



**LANGENBECK**  
G48.0040.02

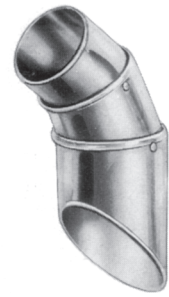

G48.0040.03



# G48

Mundsperrer DE

Mouth Gags EN

Abre-bocas ES

الكمامات فاح الفكين AR

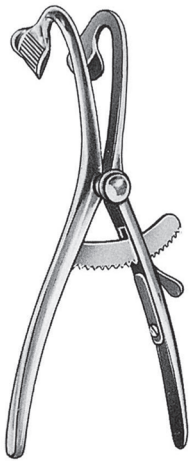

**DENHART**  
G48.0050.12 12.0cm



**DENHART**  
G48.0054.12 12.5cm

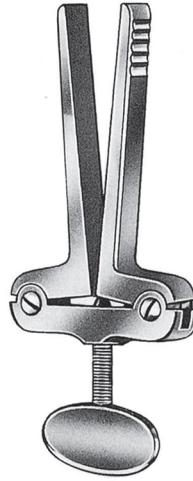

**HEISTER**  
G48.0060.13 13.0cm

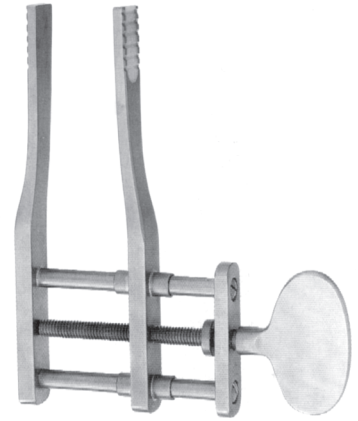

**OBWEGESER**  
G48.0064.12 12.5cm

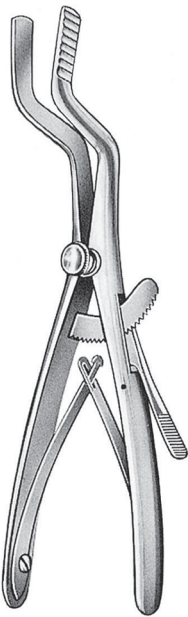

**ROSER-KÖNIG**  
G48.0070.16 16.0cm  
G48.0070.19 19.0cm

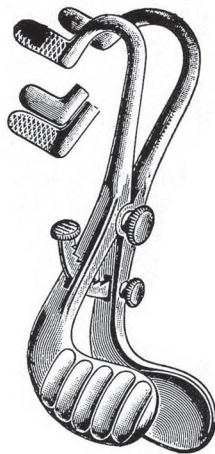

**BUXTON**  
ackland jaws parallel jaws  
G48.0080.01 G48.0080.02

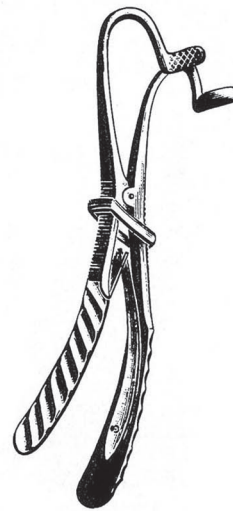

**FERGUSON**  
ackland jaws parallel jaws  
G48.0090.16 16.0cm G48.0092.16 15.0cm  
G48.0090.19 19.0cm G48.0092.19 19.0cm

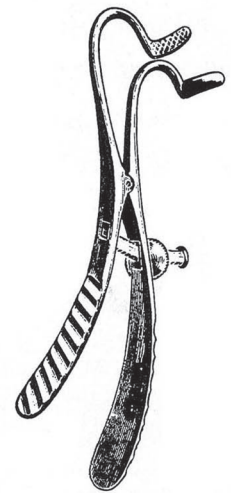

**MASON**  
ackland jaws parallel jaws  
G48.0100.15 15.0cm G48.0102.15 15.0cm  
G48.0100.19 19.0cm G48.0102.19 19.0cm

**G48-002** G48.0102.19



DE Mundsperrer  
EN Mouth Gags  
ES Abre-bocas  
AR الكمامات فاتح الفكين

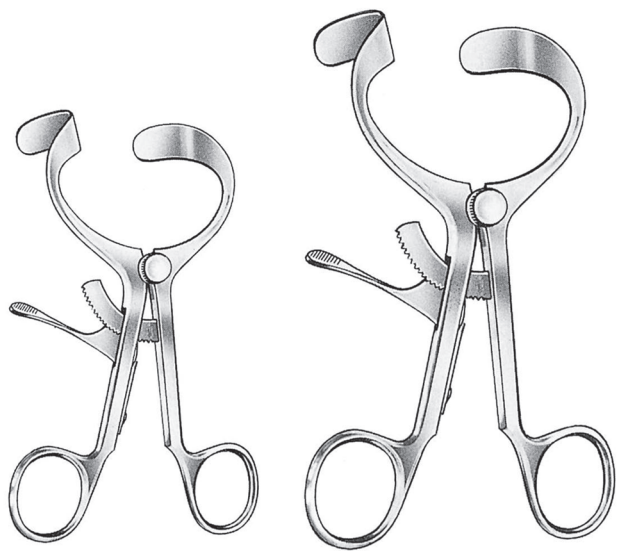

**MOLT**  
G48.0110.11 11.0cm

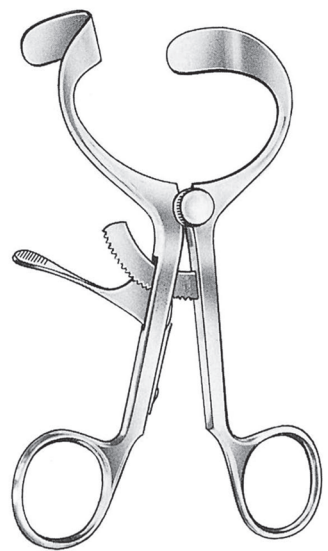

**MOLT**  
G48.0112.14 14.0cm



**MALEK**  
13.0cm

- G48.0120.00 compl. set
- G48.0120.13 frame only
- G48.0120.01 blade, fig.1, 15-19 x 36mm
- G48.0120.02 blade, fig.2, 17-21 x 44mm
- G48.0120.03 blade, fig.3, 19-23 x 59 mm
- G48.0120.04 blade, fig.4, 25-31 x 78 mm



fig. 1  
fig. 2  
fig. 3  
fig. 4



**KILNER-DOUGHTY**  
G48.0124.00 compl. set  
G48.0124.10 frame only



fig. 1

G48.0124.01



fig. 2

G48.0124.02



fig. 3

G48.0124.03



fig. 4

G48.0124.04

G48.0124.04 **G48-003**

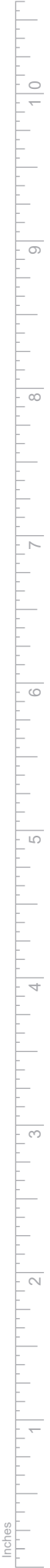

# G48

Mundsperrer DE

Mouth Gags EN

Abre-bocas ES

الكمامات فاح الفكين AR



**DAVIS-BOYLE**

G48.0130.00 compl. set  
G48.0130.10 frame only

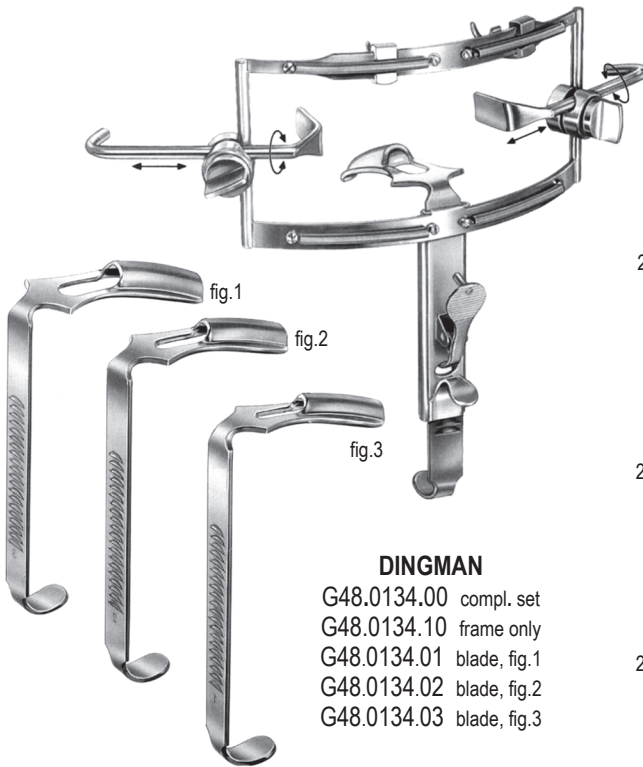

**DINGMAN**

G48.0134.00 compl. set  
G48.0134.10 frame only  
G48.0134.01 blade, fig.1  
G48.0134.02 blade, fig.2  
G48.0134.03 blade, fig.3

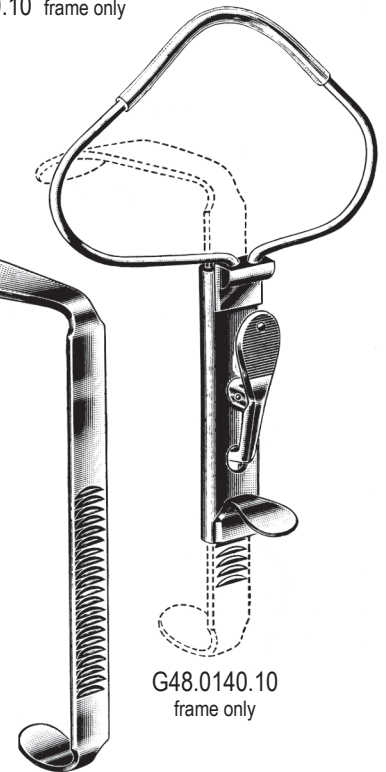

**McIVOR**

G48.0140.00 compl. set

G48-004 G48.0140.10



DE Zungendrucker  
EN Tongue Depressors  
ES Abajalenguas  
AR خافض اللسان



**LACK**  
12.0cm  
G48.0210.13 13mm  
G48.0210.19 19mm  
G48.0210.22 22mm

**HARTMANN**  
G48.0214.15 15.0cm

**TOBOLD**  
G48.0220.14 14.5cm

**TOBOLD**  
G48.0222.14 14.5cm



**ANDREW**  
G48.0226.11 11.0cm

**WIEDER**  
G48.0230.03 16.5cm

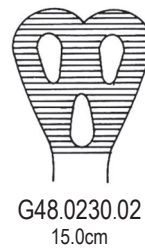
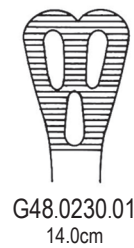

**WIEDER (modif)**  
G48.0232.14 14.5cm  
with fibre optic cable fitting

G48.0232.14 **G48-007**



# G48

Wangen-und-Lippenhalter, Zungendrucker **DE**  
 Cheek and Lip Retractors, Tongue Depressors **EN**  
 Separadores para labios y mejillas, abaja-lenguas **ES**  
 الخدوششفاه الكامشات، خافض اللسان **AR**

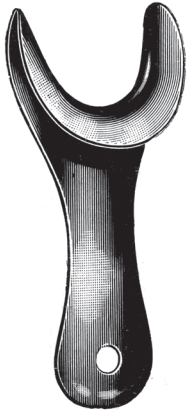

**SIMPLEX**  
G48.0170.11 11.0cm



**BISHOP**  
G48.0174.13 13.0cm



**CAWOOD**  
G48.0180.15 15.5cm



G48.0184.14 14.0cm

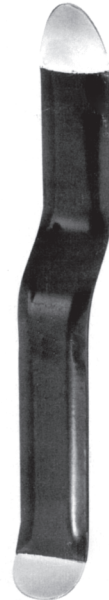

G48.0186.18 18.5cm

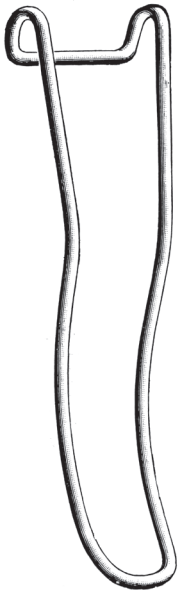

**STERNBERG**  
G48.0190.14 14.0cm  
G48.0190.16 16.0cm  
G48.0190.18 18.0cm



**STERNBERG**  
G48.0192.12 12.0cm  
G48.0192.14 14.0cm  
G48.0192.16 16.0cm



G48.0200.19 19.0cm

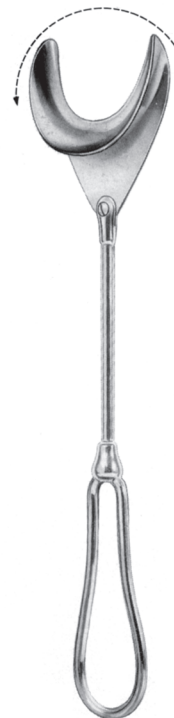

G48.0200.21 21.0cm



**ORIGINAL TESSIER**  
20.5cm  
G48.0204.01 for children  
G48.0204.02 for adults

G48-006 G48.0204.02



DE Zungendrucker  
EN Tongue Depressors  
ES Abajalenguas  
AR خافض اللسان



**LACK**  
12.0cm  
G48.0210.13 13mm  
G48.0210.19 19mm  
G48.0210.22 22mm



**HARTMANN**  
G48.0214.15 15.0cm

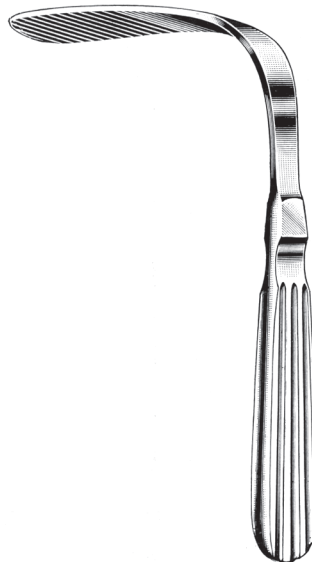

**TOBOLD**  
G48.0220.14 14.5cm

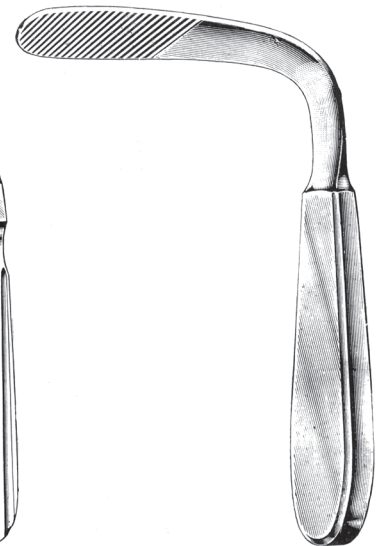

**TOBOLD**  
G48.0222.14 14.5cm



**ANDREW**  
G48.0226.11 11.0cm



**WIEDER**  
G48.0230.03 16.5cm

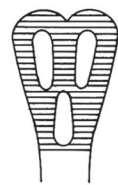

G48.0230.01  
14.0cm

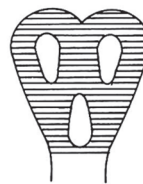

G48.0230.02  
15.0cm



**WIEDER (modif)**  
G48.0232.14 14.5cm  
with fibre optic cable fitting

G48.0232.14 **G48-007**





# G48

Zungenspatel DE

Tongue Depressors EN

Abaja-lengue ES

خافض اللسان AR

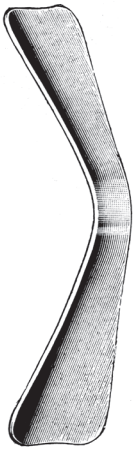

**DOYEN**  
G48.0236.13 13.0cm  
G48.0236.16 16.0cm



**KROENIG**  
G48.0240.15  
15.0cm



**MAYO**  
G48.0244.17  
17.0cm



**BRUENINGS**  
G48.0250.19  
19.0cm



**COLLIN**  
G48.0254.16  
16.5cm

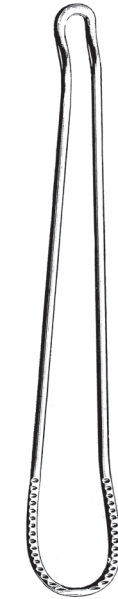

G48.0260.16  
16.5cm

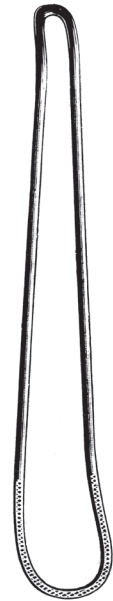

**FRENZEL**  
G48.0262.16  
16.5cm

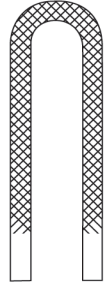

G48.0266.16  
16.0cm  
of wood



G48.0270.15  
15.0cm  
of plastic



**HAAS**  
G48.0274.16  
16.0cm  
of acrylic glass



**BUCHWALD**  
G48.0280.17  
17.0cm



G48.0284.18  
18.5cm  
nylon boilable



G48.0290.14  
14.5cm

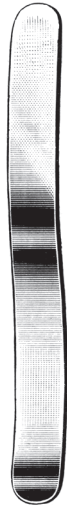

G48.0294.14  
14.5cm

**G48-008** G48.0294.14



DE Septum Scheren  
EN Septum Scissor  
ES Tijeras pára tabique nasal  
AR مقص الحاجز



**CAPLAN**  
G48.0420.21 21.5cm



**CAPLAN**  
G48.0422.21 21.0cm



# G48

Skalpellgriffe	DE
Scalpel Handles	EN
Mangos de bisturi	ES
المقابض مشرط	AR



**DUMBACH**  
G48.0400.01 15.0cm  
for blades, size 11 and 12



**DUMBACH**  
G48.0400.02 15.0cm  
for blades, size 11,12 and 15



**DUMBACH**  
G48.0400.03 15.0cm  
for blades, size 11,12 and 15



G48.0404.15 15.0cm  
for blades, size 9-17, 40 and 42



G48.0410.14 14.5cm  
No.3, straight



G48.0411.14 14.5cm  
No.3, angled



G48.0412.16 16.0cm  
No.4 straight



G48.0413.16 16.0cm  
No.4, angled

**G48-010** G48.0413.16



DE Septum Scheren  
EN Septum Scissor  
ES Tijeras pára tabique nasal  
AR مقص الحاجز



**CAPLAN**  
G48.0420.21 21.5cm



**CAPLAN**  
G48.0422.21 21.0cm





[www.gsi-medical.de](http://www.gsi-medical.de)