

- **Medical Equipment**
- **Surgical instruments**

## Rhinologie

DE Rhinologie

EN Rhinology

ES Rinologia

AR طب الأنف

**G46**

PAGE 001 to 034



DE Nasenspekula  
EN Nasal Specula  
ES Especulos nasales  
AR مناظير الأنف

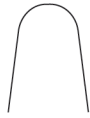

G46.0014.01

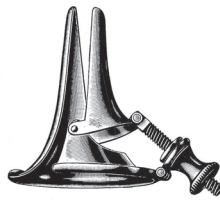

**VACHER**  
G46.0010.00

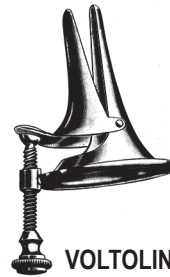

**VOLTOLINI**



G46.0014.02



G46.0014.03



Fig. 1

G46.0020.01



Fig. 2

G46.0020.02



Fig. 5

G46.0020.05



Fig. 3

G46.0020.03



Fig. 6

G46.0020.06



Fig. 4

G46.0020.04

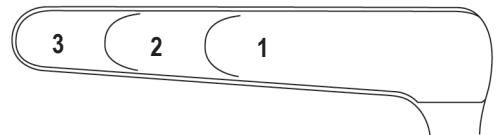

Fig. 7

G46.0020.07



**GOLDSMITH (Thudichum)**  
G46.0020.00 set / 7



**ST. CLAIR THOMSON**

G46.0024.00 set / 3

G46.0024.01 35mm Fig. 1

G46.0024.02 50mm Fig. 2

G46.0024.03 75mm Fig. 3



# G46

Nasenspekula DE

Nasal Specula EN

Especulos nasales ES

مناظير الأنف AR



**HARTMANN-HALLE**

15.0cm

G46.0030.01 Fig. 1

G46.0030.02 Fig. 2

G46.0030.03 Fig. 3

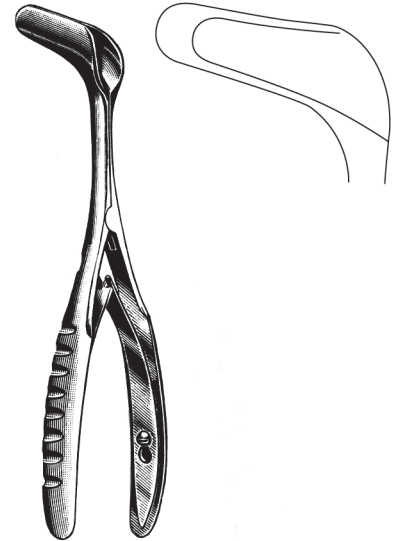
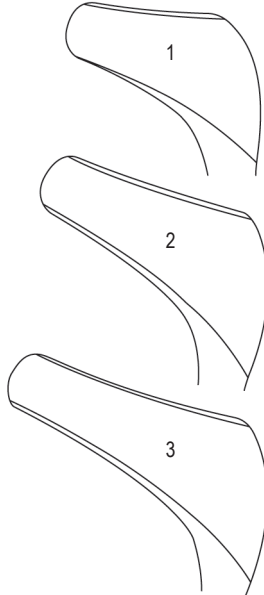

**SCHWARZ**

G46.0036.14 14.0cm

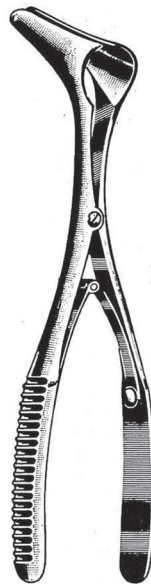

**VIENNA**

14.5cm

G46.0040.01 (infant)

G46.0040.02 (child)

G46.0040.03 (adult)

G46.0040.04 (sheet metal)



**MOD WIEN**

G46.0044.14 14.5cm

**G46-002** G46.0044.14



DE Nasenspekula  
EN Nasal Specula  
ES Especulos nasales  
AR مناظير الأنف



Pediatrics

G46.0048.13 13.0cm



G46.0049.13 13.0cm

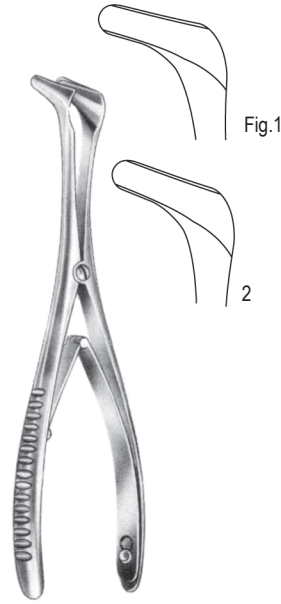

**TIECK-HALLE**  
13.5cm  
G46.0052.01  
G46.0052.02



**TIECK-HALLE**  
G46.0056.13 13.5cm



**KILLIAN**  
13.0cm  
G46.0060.35  
G46.0060.50  
G46.0060.75  
G46.0060.90

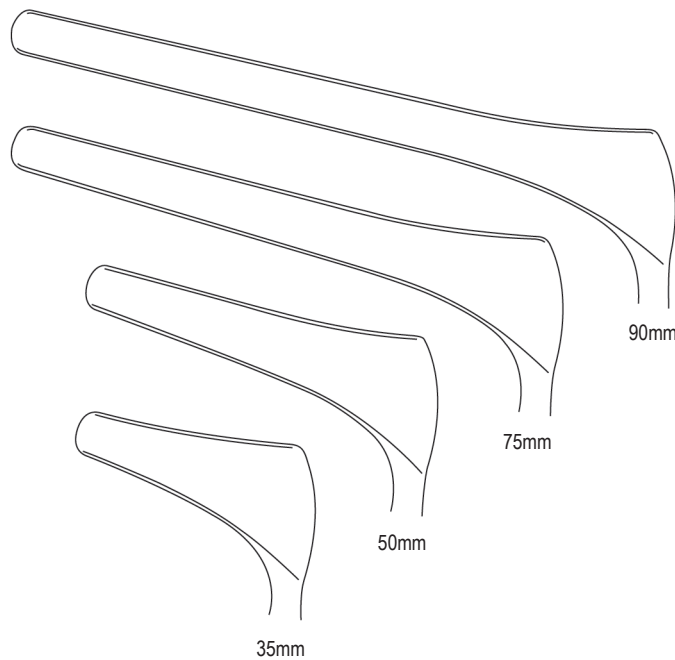

**KILLIAN (with side screw)**  
13.0cm  
G46.0062.35  
G46.0062.50  
G46.0062.75  
G46.0062.90

G46.0062.90 **G46-003**



# G46

Nasenspekula DE

Nasal Specula EN

Especulos nasales ES

مناظير الأنف AR



**COTTLE**

15.0cm  
G46.0070.35  
G46.0070.50  
G46.0070.75  
G46.0070.90

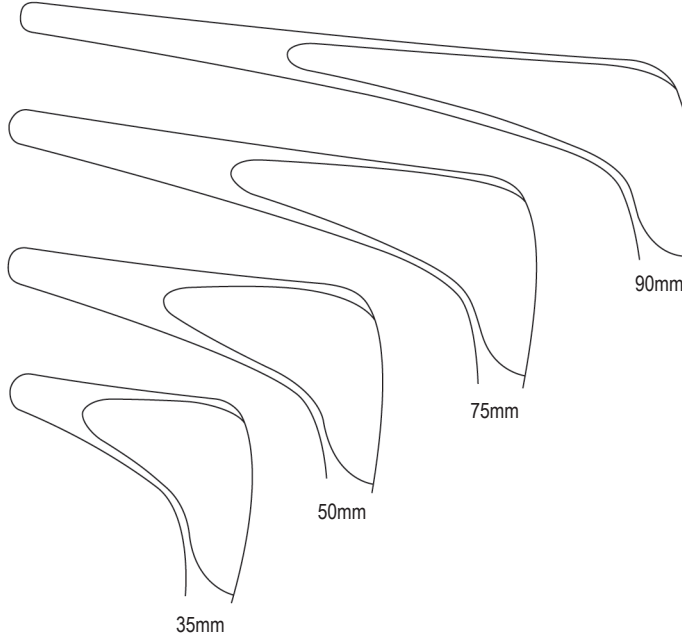

**COTTLE (with side screw)**

15.0cm  
G46.0072.35  
G46.0072.50  
G46.0072.75  
G46.0072.90



**COTTLE**  
(dull black chromium plated)  
14.0cm

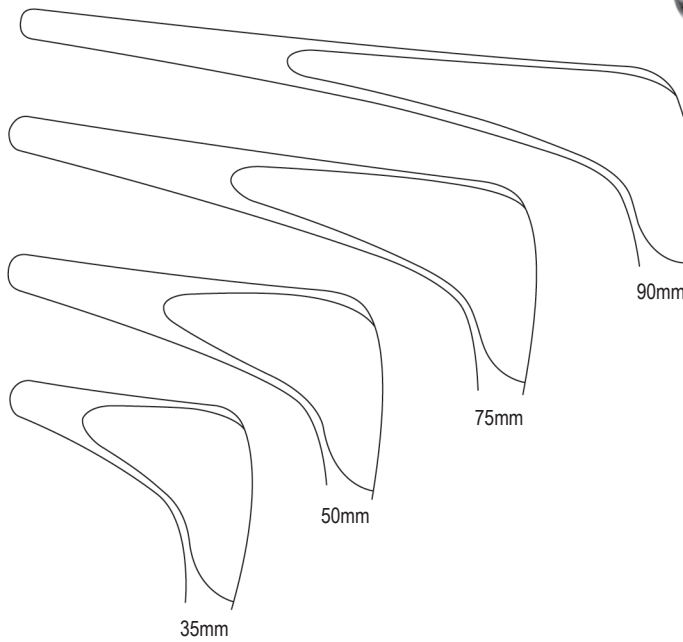

G46.0076.35  
G46.0076.50  
G46.0076.75  
G46.0076.90



**YANKAUER**  
G46.0080.19 19.0cm

**G46-004** G46.0080.19



DE Polypenschnurer  
EN Nasal Snares  
ES Polipotomos  
AR الافخاخ الأنف

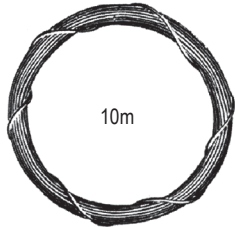

G44.0270.03 0.3mm Ø  
G44.0270.04 0.4mm Ø



G44.0274.02 0.2mm Ø  
G44.0274.03 0.3mm Ø



**KRAUSE**  
G46.0100.26 26.0cm

**KRAUSE-VOSS**  
G46.0104.26 26.0cm

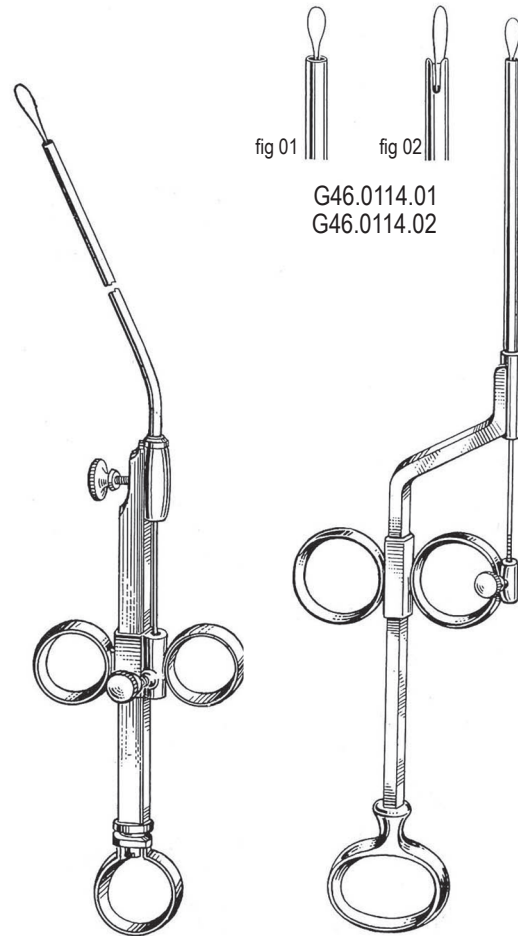

**KRAUSE**  
G46.0110.00

**GLEGG**

fig 01  
fig 02  
G46.0114.01  
G46.0114.02

G46.0114.02 **G46-005**



# G46

Polypenzangen, Septumzange DE

Nasal Polypus and Septum Compression Forceps EN

Pinzas para polipos, pinzas para el tabique nasal ES

سليطة الأنف والملقط ضغط الحاجز AR



**KILLIAN**  
G46.0120.17 17.0cm



**LITTAUER**  
G46.0124.18 18.0cm

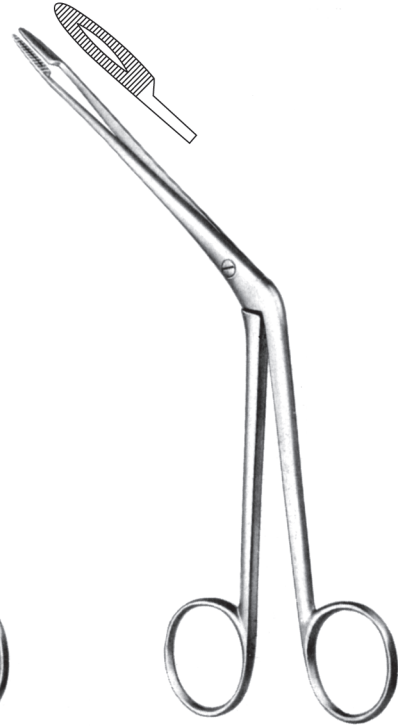

**HARTMANN**  
G46.0130.20 20.0cm



**QUIRE**  
G46.0134.12 12.0cm

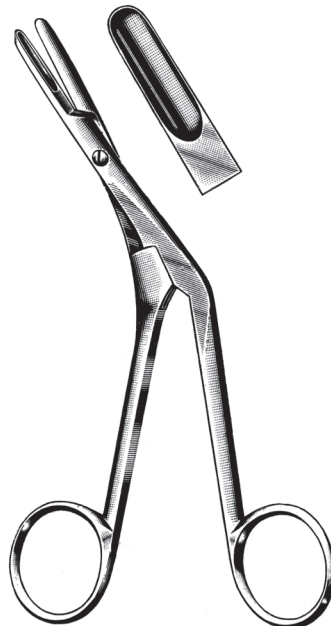

**GRAIG**  
G46.0140.18 18.0cm



G46.0144.01 G46.0144.02

18.0cm

G46-006 G46.0144.02



DE Polypenzangen, Septumzange  
 EN Nasal Polypus and Septum Compression Forceps  
 ES Pinzas para polipos, pinzas para el tabique nasal  
 AR سلية الأنف والملقط ضغط الحاجز



**KNIGHT**  
G46.0150.18 18.0cm

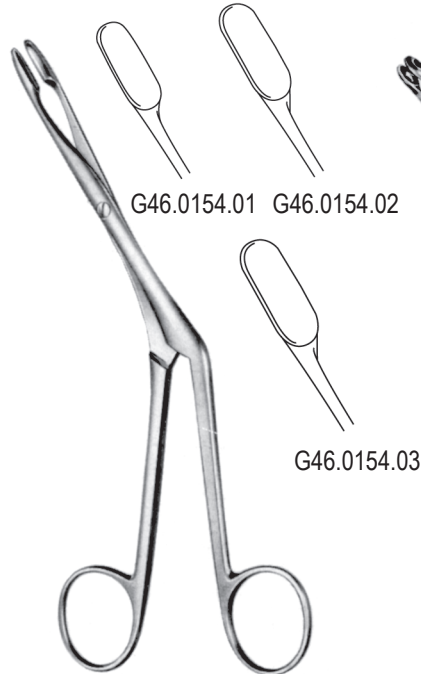

**HEYMANN**  
18.0cm

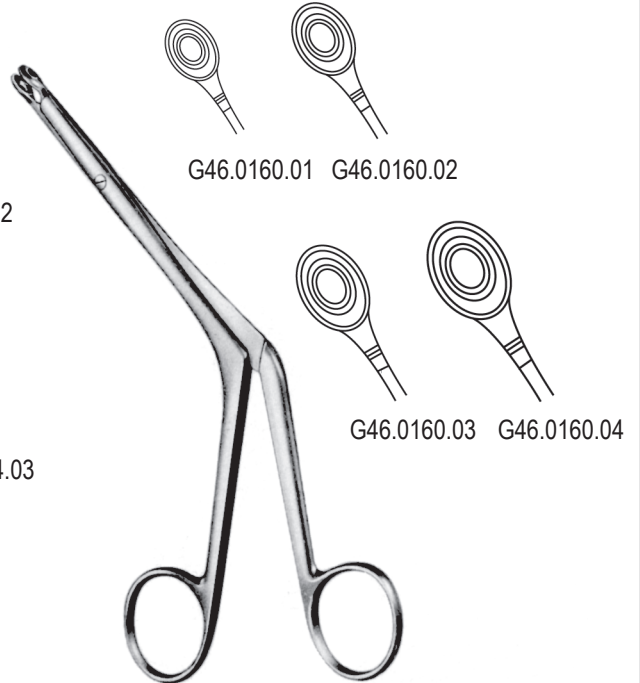

**BRUENINGS**  
19.0cm

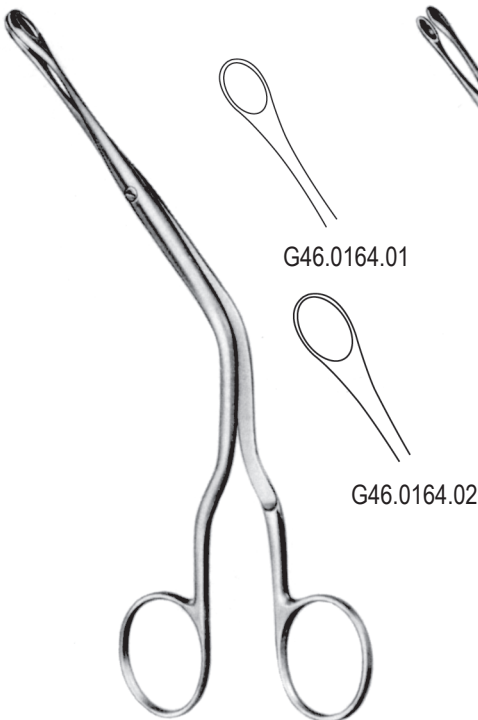

**LUC**  
20.0cm

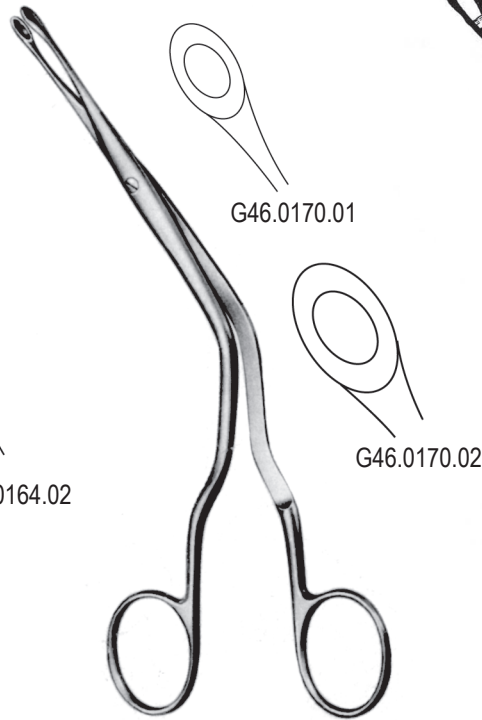

**LUC**  
20.0cm

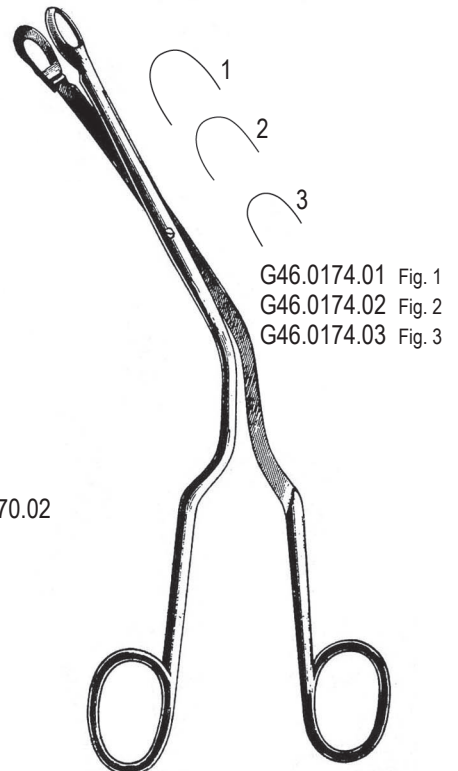

**LUC**  
20.0cm

G46.0174.03 **G46-007**





Tamponpinzetten und-zangen, Polypenzangen DE

Dressing and Tampon Forceps, Nasal Polypus Forceps EN

Pinzas para compresas y taponamientos, pinzas para pollipos ES

الملقط الضماد والملقط الدك AR

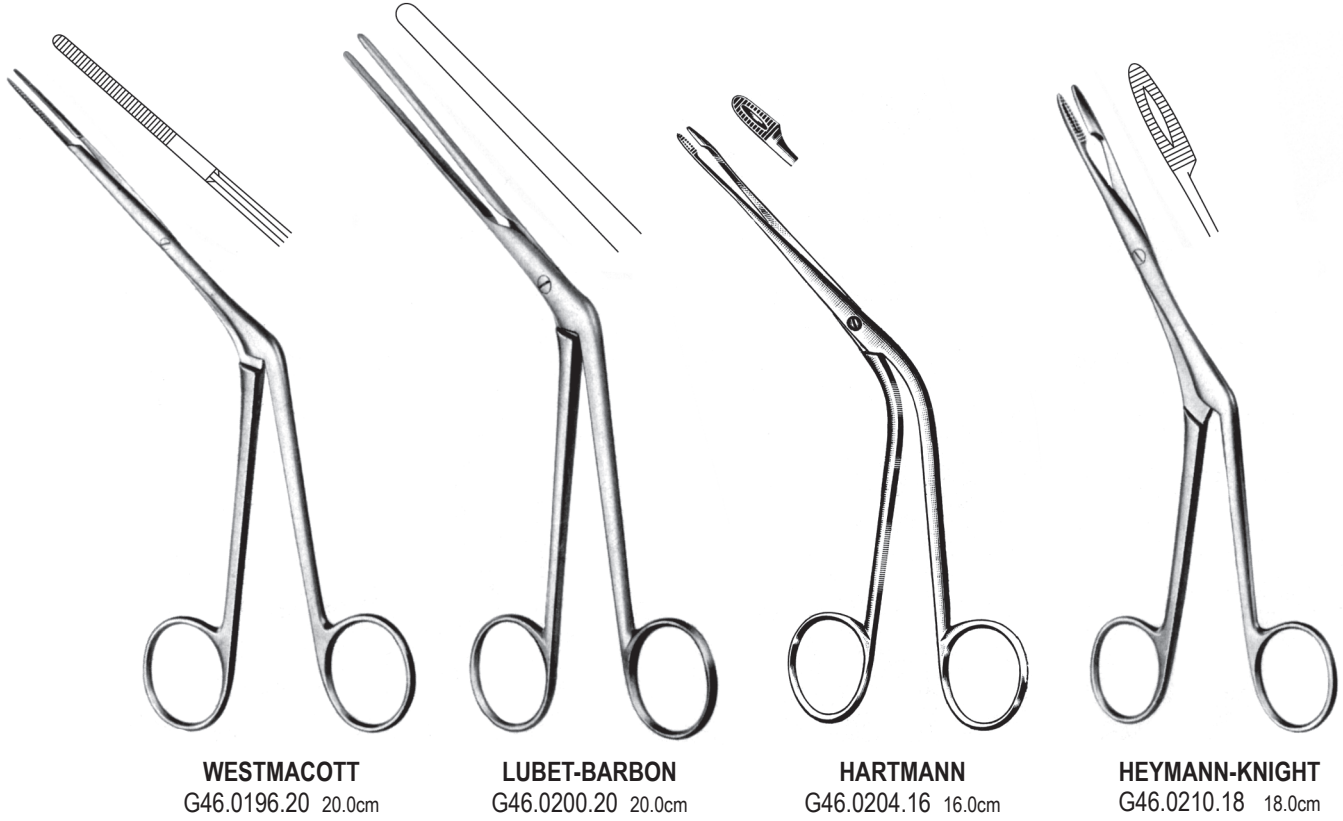
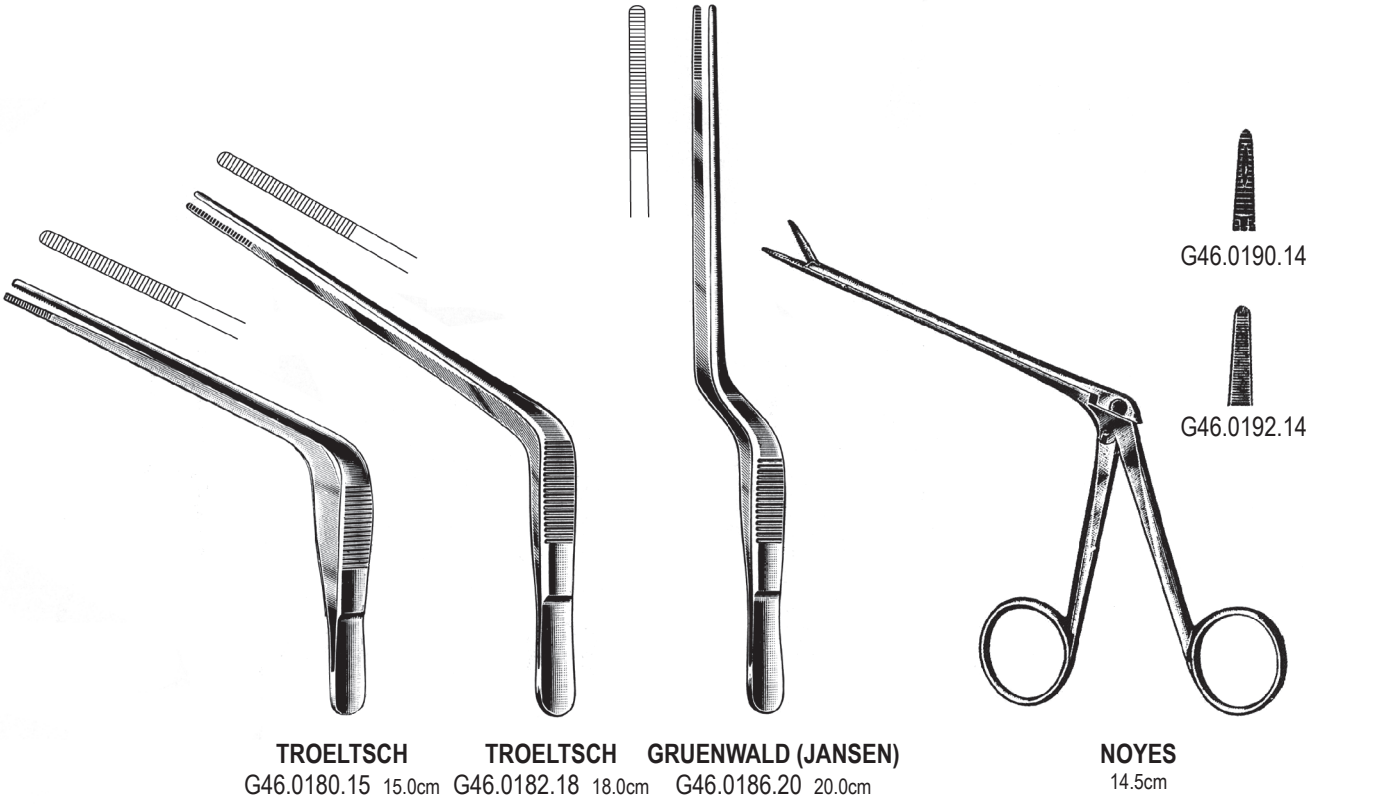

**G46-008** G46.0210.18

DE Scharfe Nasenzangen

EN Nasal Cutting Forceps

ES Pinzas cortantes cara la nariz

AR الملقط قطع الأنف

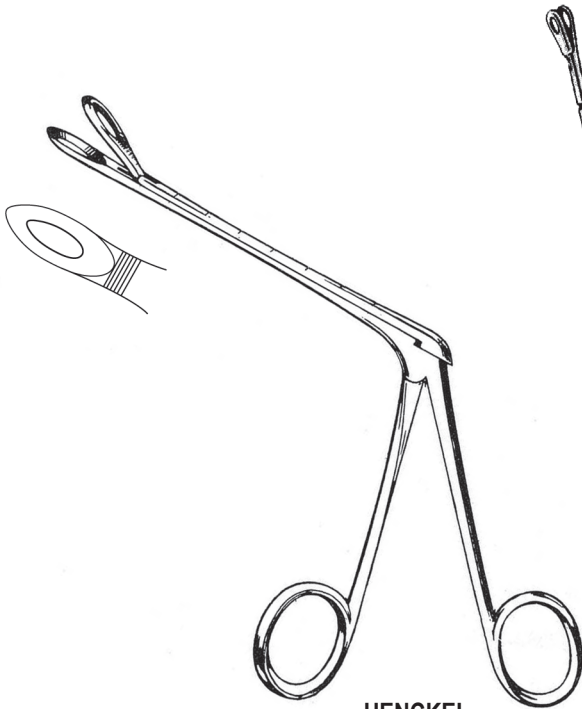

**HENCKEL**  
G46.0214.20 20.0cm



**JATHO**  
G46.0220.15

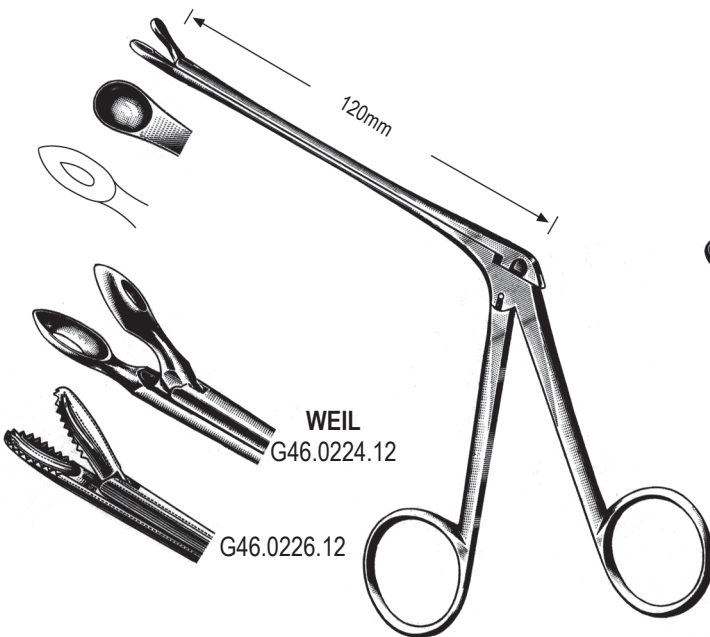

**WATSON-WILLIAMS**  
G46.0222.12 19.0cm

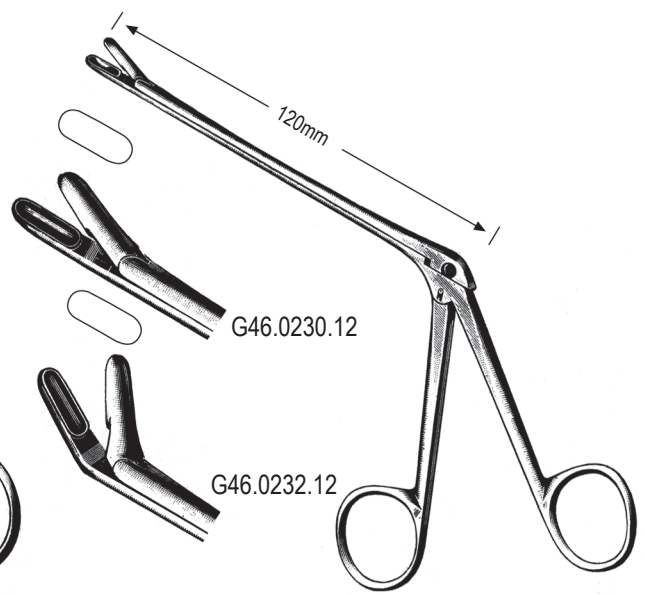

**TAKAHASHI**  
19.0cm

G46.0232.12 **G46-009**



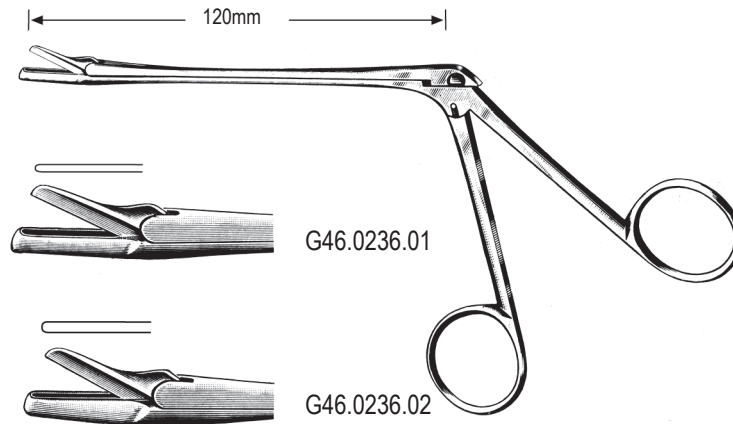

**STRUYCKEN**  
19.0cm

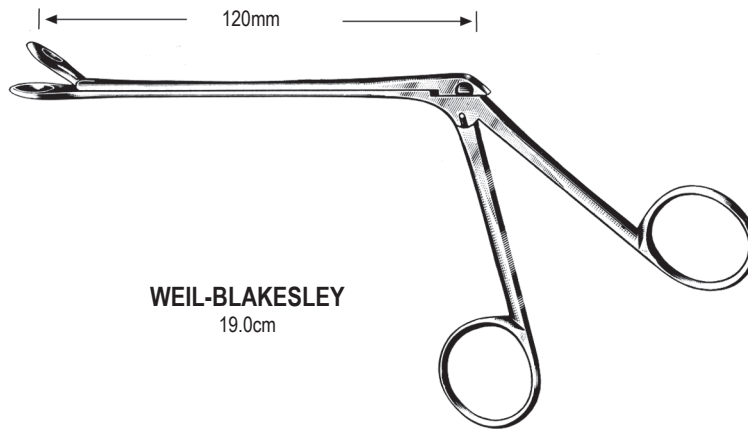

**WEIL-BLAKESLEY**  
19.0cm



DE **Scharfe Nasenzangen**  
 EN **Nasal Cutting Forceps**  
 ES **Pinzas cortantes cara la nariz**  
 AR **الملقط قطع الأنف**

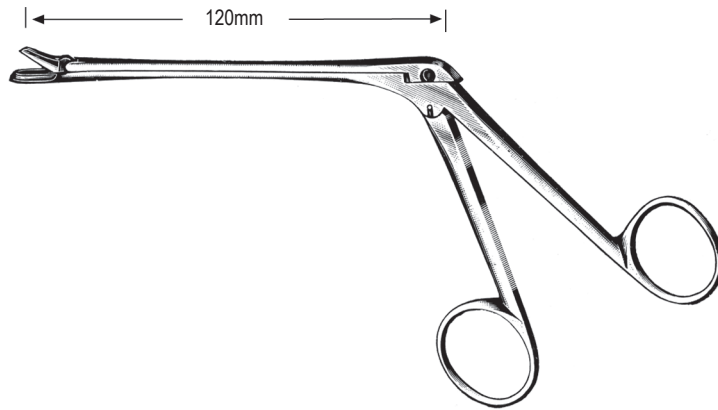

**HAJEK**  
19.0cm

G46.0250.12

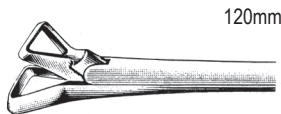

**SCHMEDEN**  
19.0cm

G46.0254.12

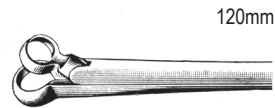

**HARTMANN**  
19.0cm

G46.0260.01  
5mm

G46.0260.02  
7mm

G46.0260.03  
9mm

G46.0260.04  
11mm

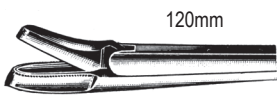

**MYLES**  
19.0 cm

G46.0264.01  
2.2mm

G46.0264.02  
2.6mm

G46.0270.01

G46.0270.02

G46.0264.03  
3mm

G46.0264.04  
3.4mm

G46.0270.03



# G46

Keibeinstanzen, Meibelzangen DE

Sphenoid Punches and Rongeur Forceps EN

Pinzas cortantes para seno esfesoidal, pinzas-gubias ES

اللكمات الوتدي، مقراض الملقط AR

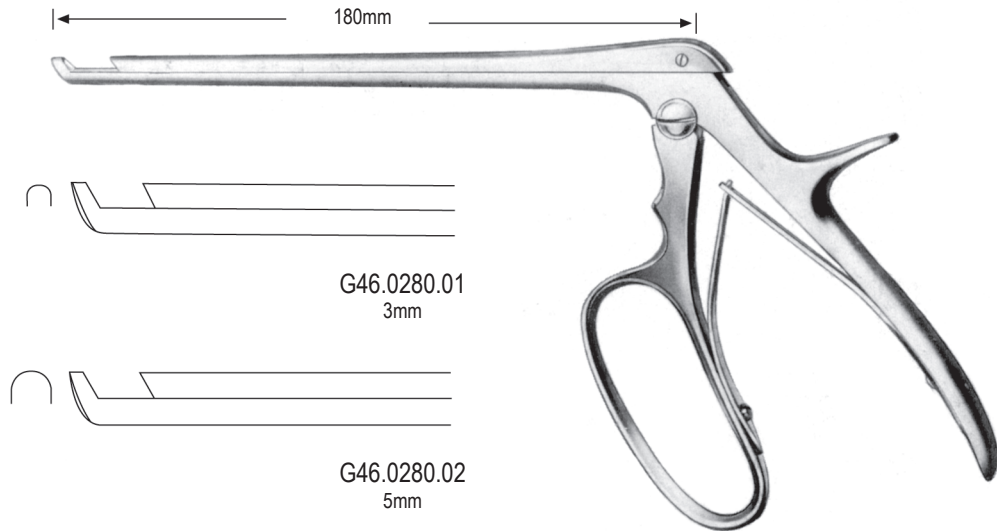

**FERRIS-SMITH-KERRISON  
(CLOWARD HARPER)**

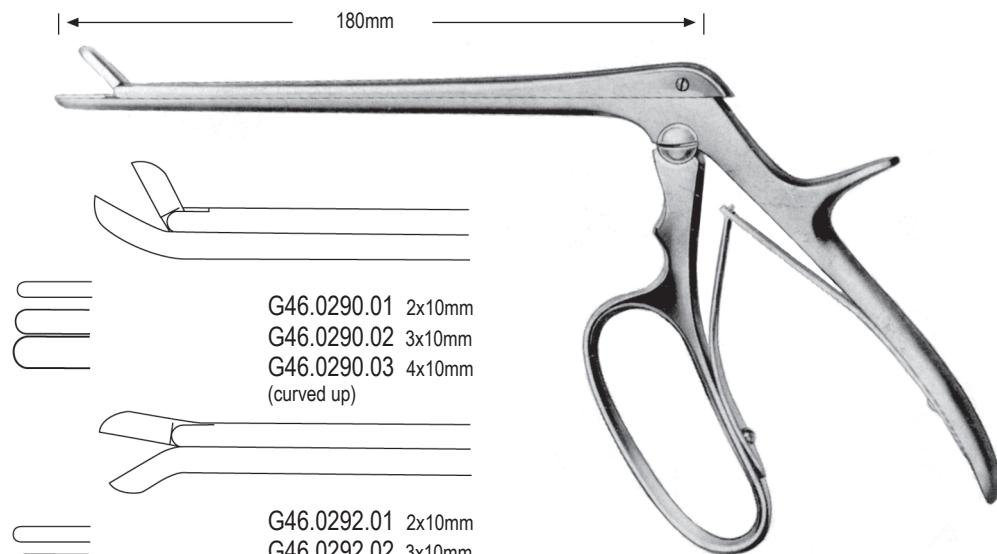

**FERRIS-SMITH-CUSHING**

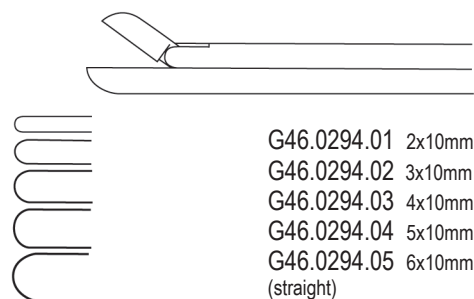

G46.0294.01 2x10mm  
G46.0294.02 3x10mm  
G46.0294.03 4x10mm  
G46.0294.04 5x10mm  
G46.0294.05 6x10mm  
(straight)

**G46-012** G46.0294.05



- DE Keibeinstanzen, Kieferhohlenstanzen
- EN Sphenoid Punches, Antrum Punch Forceps
- ES Pinzas cortantes para seno esfenoidal y maxilar
- AR خرامة الوتدي والملقط قطع العظام

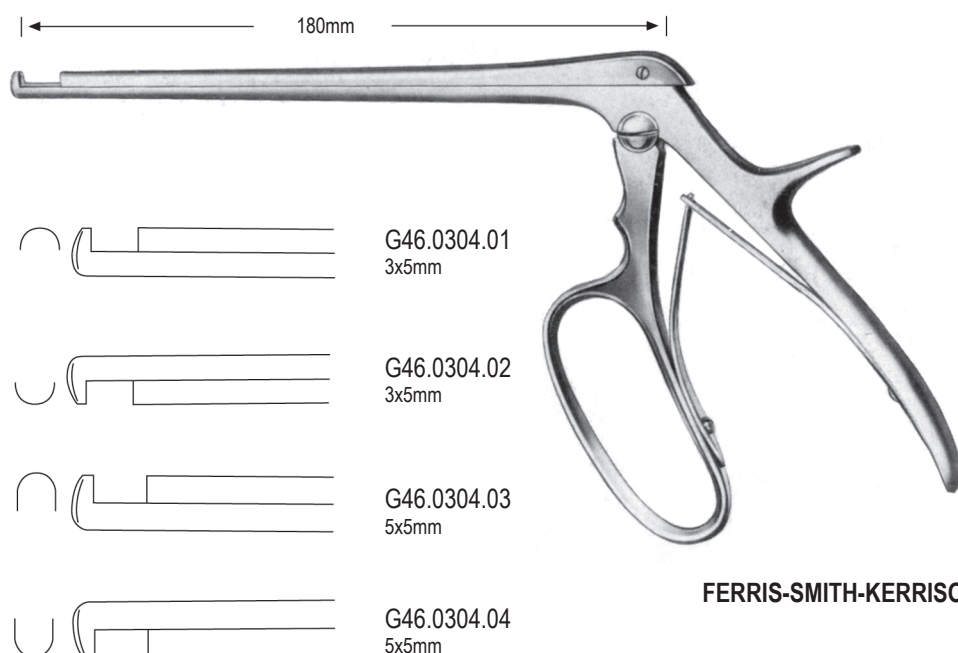
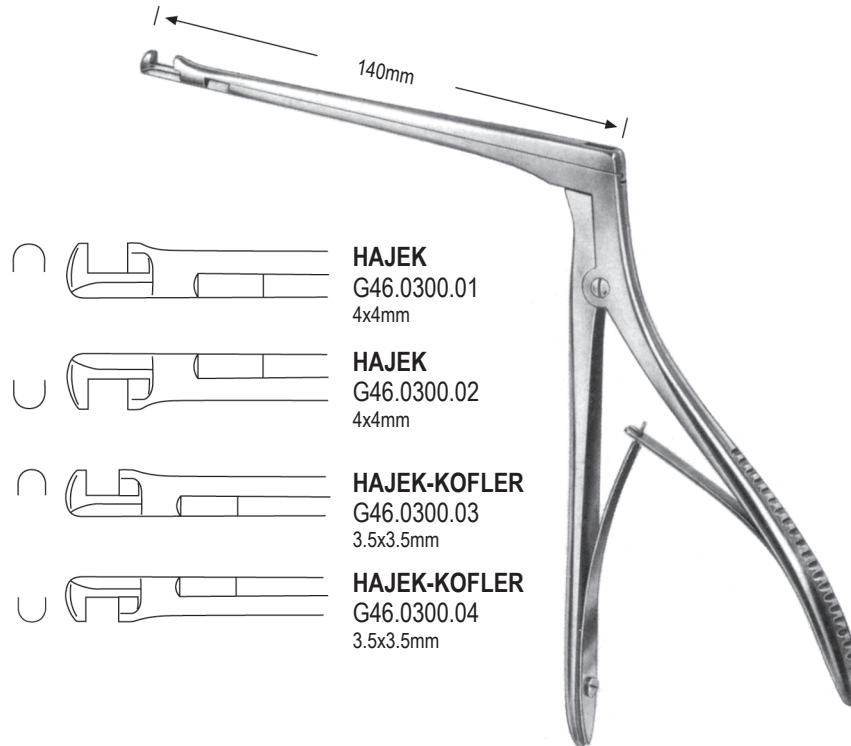

**FERRIS-SMITH-KERRISON**

G46.0304.04 **G46-013**



# G46

Keilbeinstanzen, Kieferhohlenstanzen DE  
Sphenoid Punches, Antrum Punch Forceps EN  
Pinzas cortantes para seno esfenoidal y maxilar ES  
اللكمات الوتدي، التجوييف لكمة الملقط AR



**KERRISON**  
20.0cm



**HAJEK-CLAUS**  
G  
46.0312.20 20.0cm



**CITELLI**  
G46.0314.10 1mm  
G46.0314.25 2.5mm  
G46.0314.30 3mm  
G46.0314.35 3.5mm  
G46.0314.40 4mm



**BEYER**  
G46.0316.19 2mm



**BEYER**  
G46.0318.19 1mm

**G46-014** G46.0318.19



DE Septum Compression Forceps, Septum Scissors

EN Septum Compression Forceps, Septum Scissors

ES Pinzas para el tabique nasal, tijeras para el tabique nasal

AR الملقط ضغط الحاجز، مقص الحاجز

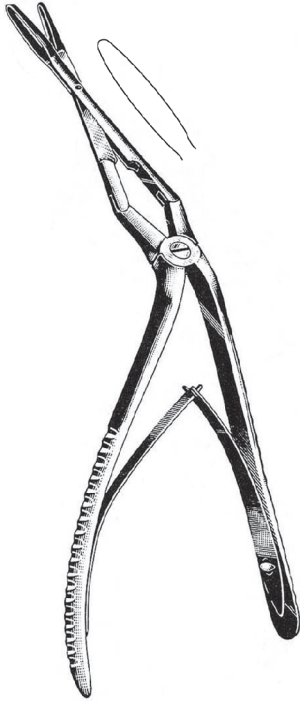

**JANSEN-STRUYCKEN**  
G46.0320.19 19.0cm



**MIDDLETON-JANSEN**  
G46.0322.19 19.0cm



**MIDDLETON-JANSEN**  
G46.0324.19 19.0cm



**CAPLAN**  
G46.0330.20  
20.0cm

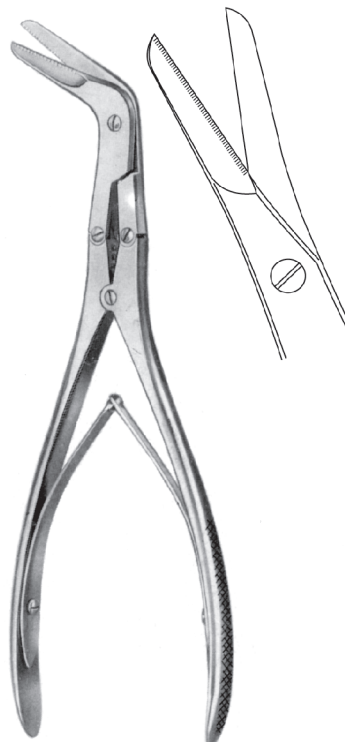

**KILLIAN**  
G46.0334.21  
21.0cm



**RUBIN**  
G46.0340.21  
21.0cm

G46.0340.21 **G46-015**





# G46

Nasenplastik-und Operationsmesser DE

Rhinoplastic and Nasal Knives EN

Bisturías para plástica y operaciones de la nariz ES

السكاكين رأب الأنف والأنف AR



**JOSEPH (sharp)**  
15.0cm

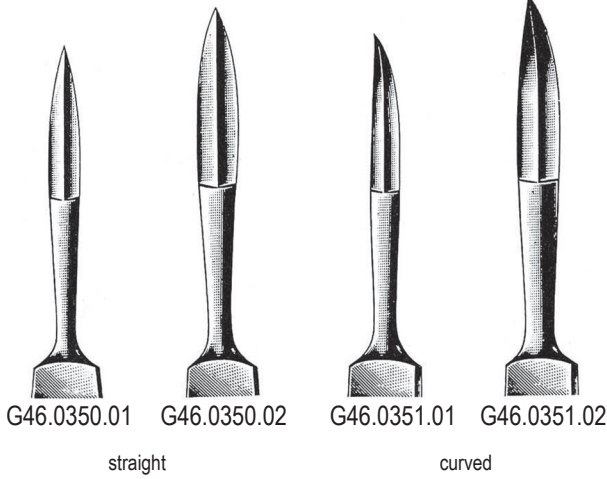

straight

curved



**JOSEPH (blunt)**  
15.0cm

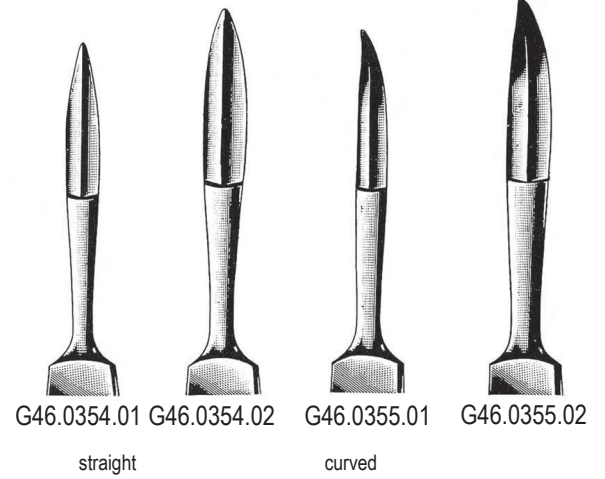

straight

curved



**BALLENGER**  
G46.0360.00



**FOMON**  
G46.0364.16  
16.0cm



**CONVERSE**  
G46.0370.16  
16.0cm

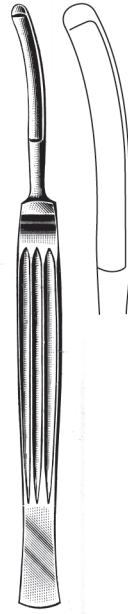

**JOSEPH**  
G46.0374.15  
15.0cm



**COTTLE**  
G46.0380.15  
15.0cm



**COTTLE**  
G46.0384.15  
15.0cm

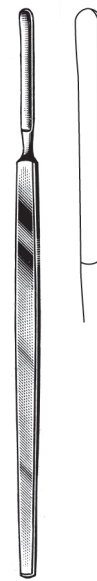

**HEYMANN**  
G46.0390.00



**KRIEG**  
G46.0394.00

**G46-016** G46.0394.00

DE Septummesser, Mukosamesser, Schwingmesser

EN Septum Knife, Mucous Knives, Swivel Knives

ES Cuchillo para el tabique nasal, la mucosa, cuchillos y hojas movibles

AR سكين الحاجز، سكاكين مخاط، سكاكين دوارة



**BALLENGER**  
20.0cm



G46.0400.03  
3mm



G46.0400.04  
4mm



G46.0400.05  
5mm



**BALLENGER**  
20.0cm



G46.0401.03  
3mm



G46.0401.04  
4mm

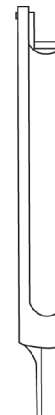

G46.0401.05  
5mm



**BRUENINGS**  
46.0404.16 16.5cm



**FREER**  
G46.0406.00



**FREER**  
G46.0408.15  
15.0cm



**FREER**  
G46.0410.19  
19.0cm



**FREER**  
G46.0412.19  
19.0cm



**FREER**  
G46.0414.19  
19.0cm

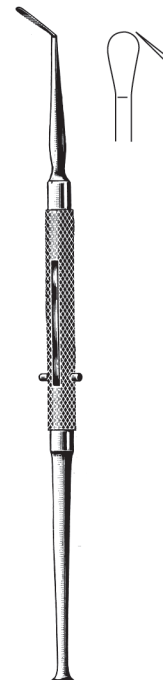

**FREER**  
G46.0416.19  
19.0cm



# G46

Septum-Elevatoren und Raspatorien **DE**  
 Septum Elevators and Raspatories **EN**  
 Elecadores para el tabique nasal y lagras **ES**  
 مبردو رافع الشظية **AR**



**McKENTY**  
15.0cm

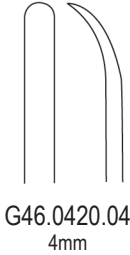

G46.0420.04  
4mm

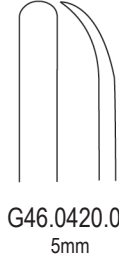

G46.0420.05  
5mm



**HALLE**  
G46.0424.16  
16.5cm



**JOSEPH**  
G46.0430.16  
16.0cm



**FREER**  
G46.0434.19  
19.0cm



**FREER**  
G46.0436.19  
19.0cm

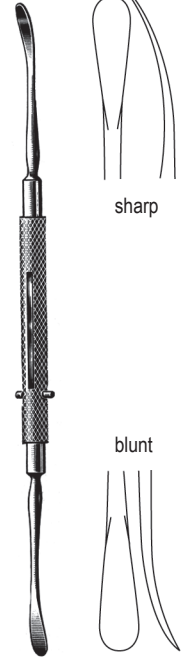

**FREER**  
G46.0440.18  
18.0cm



**BALLENGER**  
G46.0444.22  
22.0cm

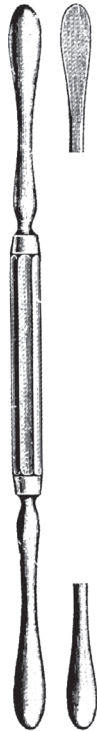

**HAJEK-BALLENGER**  
G46.0450.22  
22.0cm

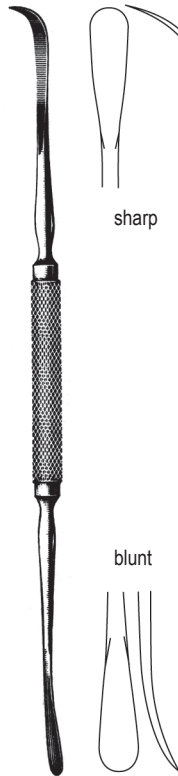

**FREER**  
G46.0454.20  
20.5cm



**FREER**  
G46.0460.20  
20.0cm



**DURHAM**  
G46.0464.19  
19.0cm



**HOWARTH**  
G46.0470.22  
22.0cm

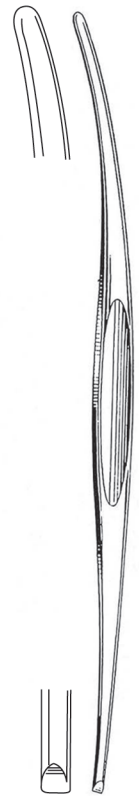

**HILL**  
G46.0474.22  
22.0cm

**G46-018** G46.0474.22



DE Septum-und Periost-Elevatoren  
 EN Septum and Periosteal Elevators  
 ES Elevadores para el tabique nasal y para el periostia  
 AR الحاجز ومساعد السمحاقى



**KILLIAN**  
G46.0480.18  
18.0cm

**KILLIAN**  
G46.0484.22  
22.0cm

**PIERCE**  
46.0490.21  
21.0cm

**PENNINGTON**  
G46.0494.21  
21.0cm

**ROGER**  
G46.0500.19  
19.0cm

**McKENTY**  
G46.0504.22  
22.0cm

**COTTLE**  
G46.0510.23  
23.0cm

G46.0510.23 **G46-019**



Septum-und Periost-Elevatoren DE

Septum Elevators and Raspatories EN

Elevadores para el tabique nasal y para el periostio ES

الحاجز ومساعد السمحاقى AR

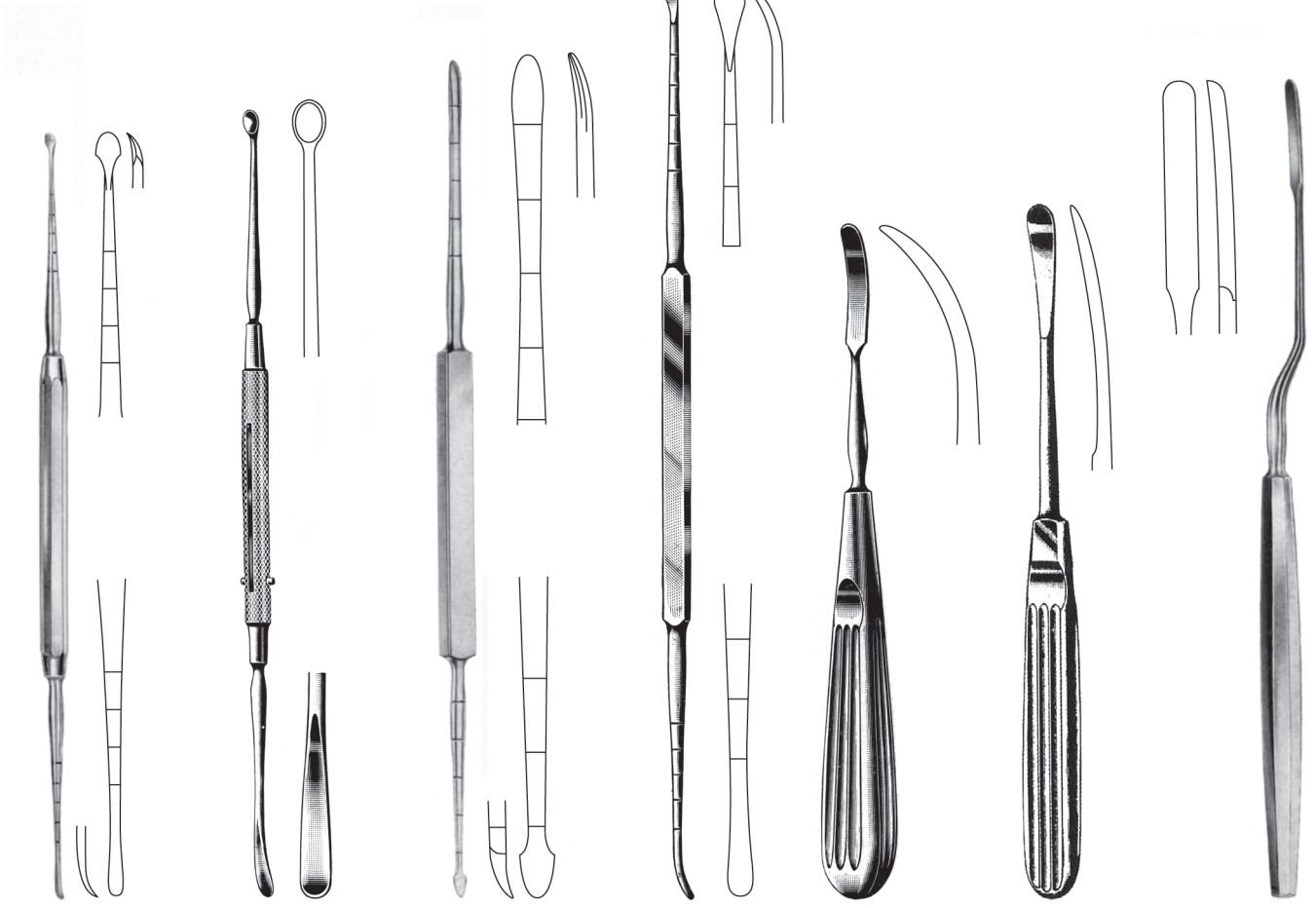

**MASING**  
G46.0514.21  
21.0cm

**CARTER**  
G46.0520.21  
21.0cm

**COTTLE**  
G46.0524.21  
21.0cm

**COTTLE**  
G46.0530.22  
22.0cm

**JOSEPH**  
G46.0534.16  
16.0cm

**COTTLE**  
G46.0540.19  
19.0cm

**JOSEPH-MASING**  
G46.0544.22  
22.0cm

DE Septum-Hohlmeißel, -Meißel  
 EN Septum Gouges, Chisels  
 ES Gubias y cinceles para tabique nasal  
 AR الحفارات الحاجز منقاش



**KILLIAN**  
G46.0550.17 17.0cm

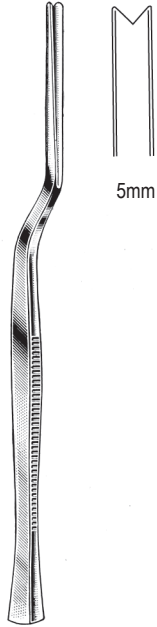

**KILLIAN-CLAUS**  
G46.0554.17 17.0cm



**BALLENGER**



**FREER**  
G46.0564.15  
15.0cm



**WEST**  
G46.0570.16 16.0cm



**WEST**  
G46.0572.16 16.0cm



**FREER**  
G46.0580.16

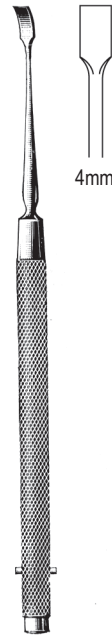

**FREER**  
G46.0582.16

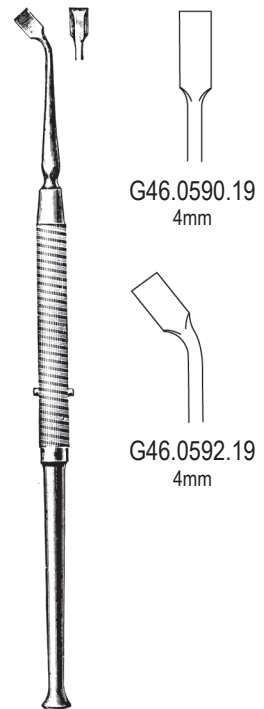

**FREER**

G46.0592.19 **G46-021**



# G46

Nasel Sägen, Nasenmeißel, Osteotome DE

Nasal Saws, Chisels, Osteotomes EN

Sierras nasales, cinceles nasales, osteótomos ES

مناشير الأنف، أزامل، العظم AR



G46.0600.17

G46.0602.17

**JOSEPH**  
17.0cm

**JOSEPH**  
19.0cm

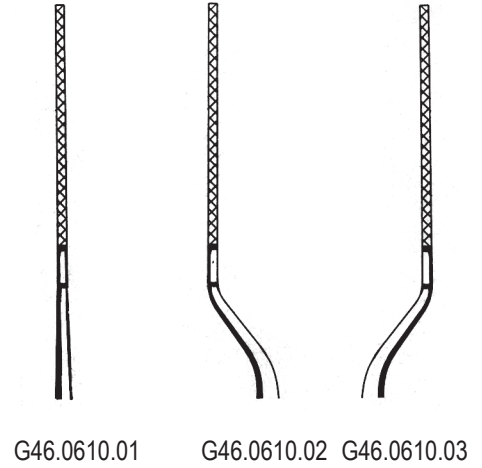

G46.0610.01

G46.0610.02

G46.0610.03

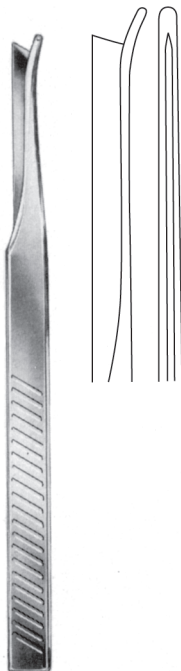

**SILVER**  
G46.0614.01

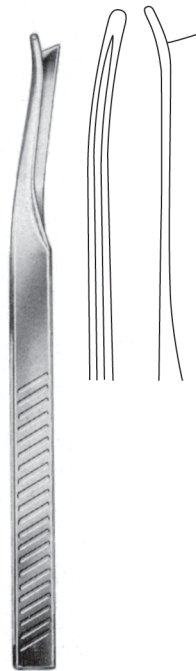

**SILVER**  
G46.0614.02 18.0cm

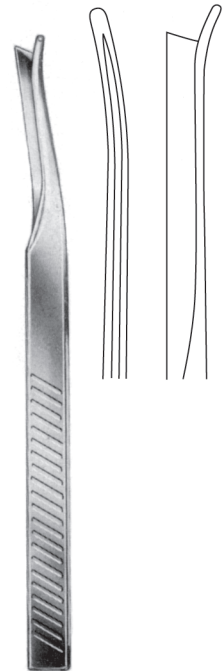

**SILVER**  
G46.0614.03

**G46-022** G46.0614.03



DE Osteotome, Hohlmeißel, Meißel  
 EN Osteotomes, Gouges, Chisels  
 ES Osteótomos, gubias, cinceles  
 AR العظم، الحفارات، أزامليل



**COTTLE**  
G46.0620.18 18.0cm

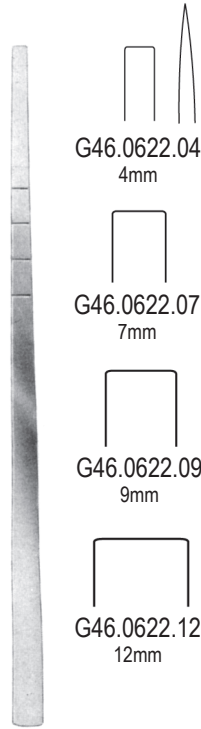

**COTTLE**  
18.0cm

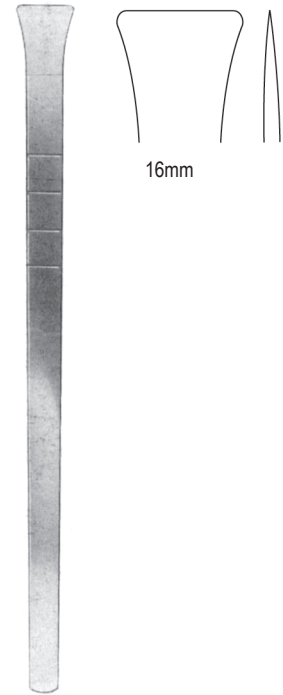

**COTTLE**  
G46.0624.18 18.0cm

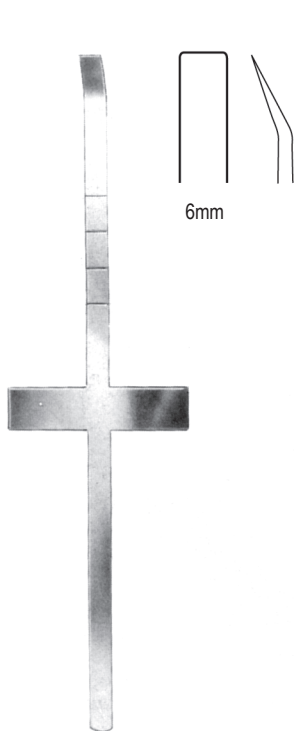

**COTTLE**  
G46.0623.18 18.0cm

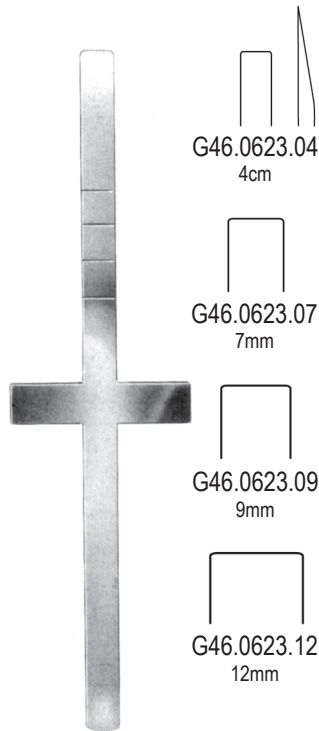

**COTTLE**  
18.0cm

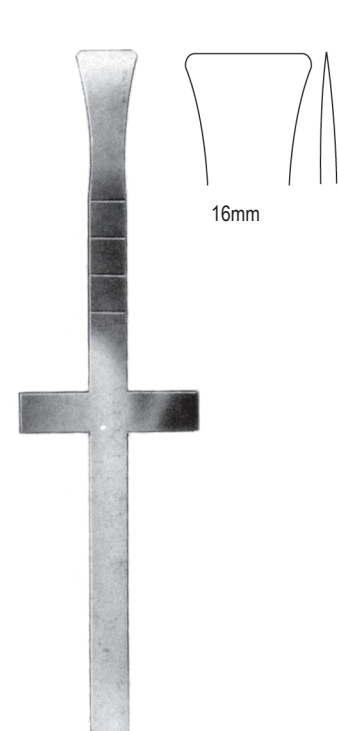

**COTTLE**  
G46.0625.18 18.0cm

G46.0628.18 **G46-023**





# G46

Osteotome, Hohlmeißel, Meißel **DE**

Osteotomes, Gouges, Chisels **EN**

Osteótomos, gubias, cincelos **ES**

العظم، الحفارات، أزامل **AR**

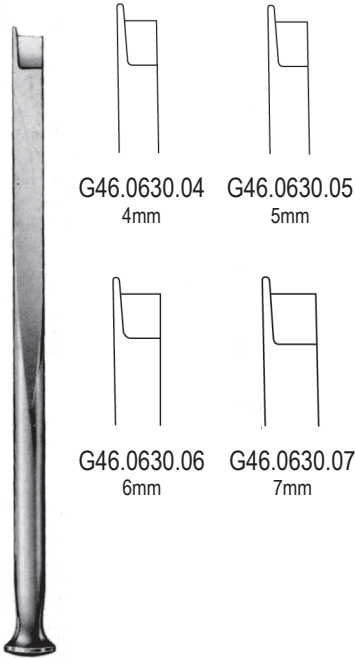

G46.0630.04 4mm  
G46.0630.05 5mm

G46.0630.06 6mm  
G46.0630.07 7mm

**FOMON**  
17.0cm

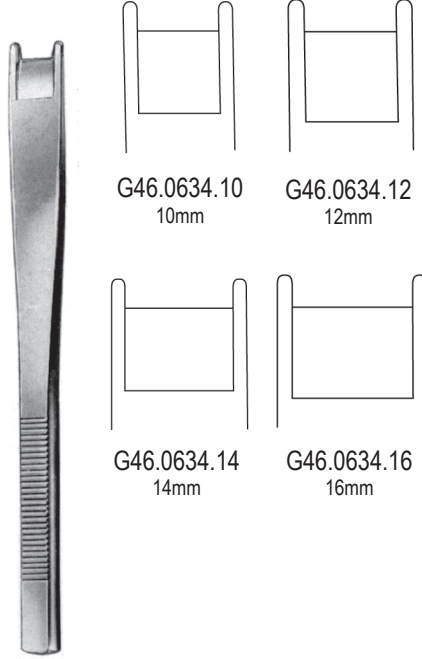

G46.0634.10 10mm  
G46.0634.12 12mm

G46.0634.14 14mm  
G46.0634.16 16mm

**CINELLI**  
16.0cm

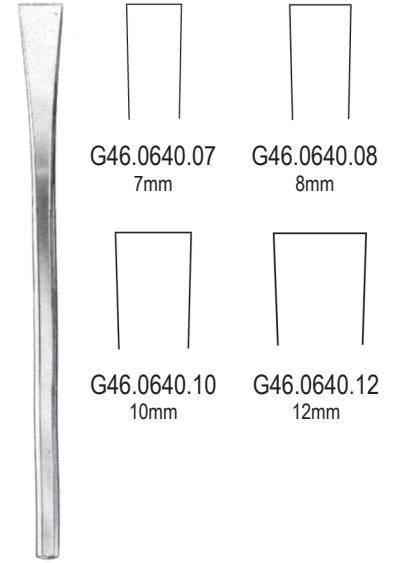

G46.0640.07 7mm  
G46.0640.08 8mm

G46.0640.10 10mm  
G46.0640.12 12mm

**SHEEHAN**  
17.0cm

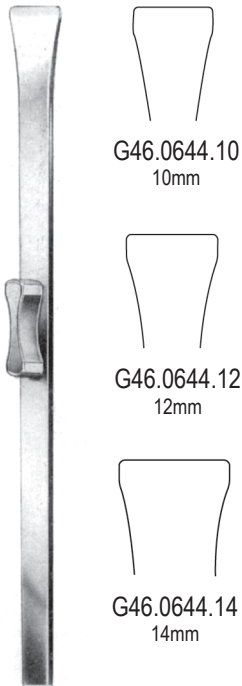

G46.0644.10 10mm

G46.0644.12 12mm

G46.0644.14 14mm

**RUBIN**  
18.0cm



G46.0650.03 3mm

G46.0650.04 4.5mm

**WALTER**  
19.0cm

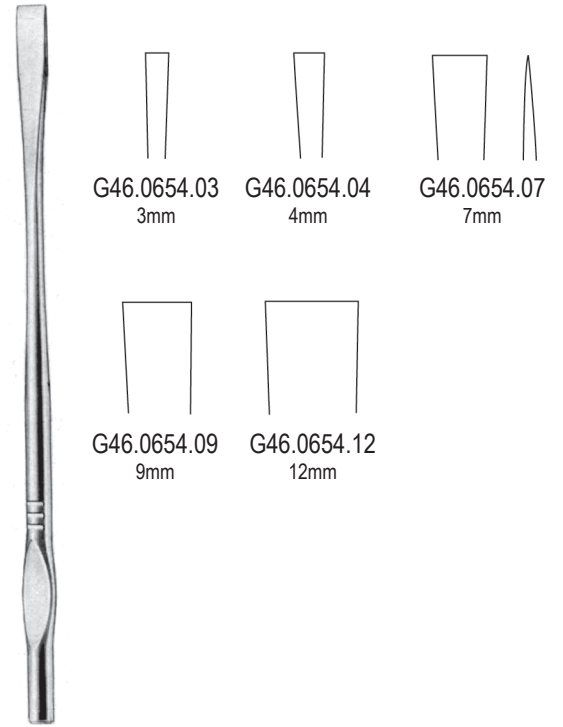

G46.0654.03 3mm  
G46.0654.04 4mm  
G46.0654.07 7mm

G46.0654.09 9mm  
G46.0654.12 12mm

**WALTER**  
19.0cm

**G46-024** G46.0654.12



DE Knochenfeilen, Nasenraspeln, Antrumraspeln

EN Nasal Rasps, Bone Files, Antrum Rasps

ES Limas para huesos, escofinas nasales, escofinas para el antro

AR المبارد الأنف، ملفات العظام، المبارد التجويف

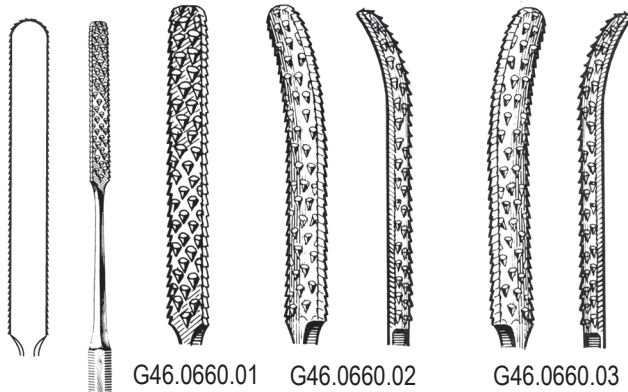

G46.0660.01

G46.0660.02

G46.0660.03

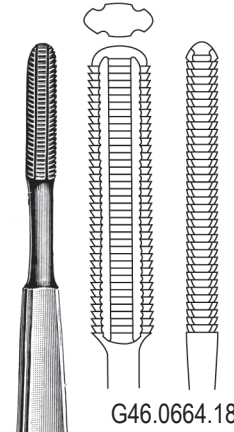

G46.0664.18

G46.0670.16



**GALLAHER**  
16.0cm

**MALTZ**  
18.0cm

**JOSEPH**  
16.0cm

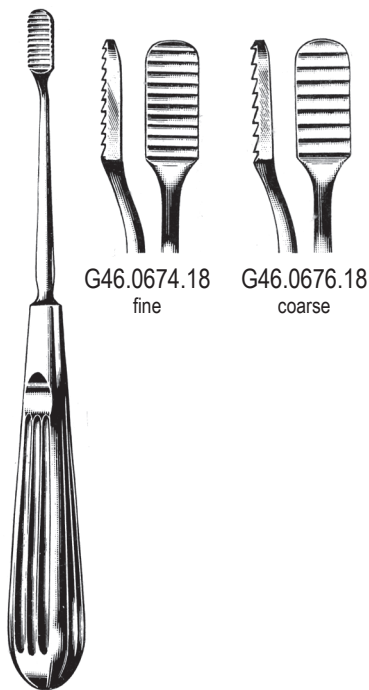

G46.0674.18  
fine

G46.0676.18  
coarse

**LEWIS**  
18.0cm

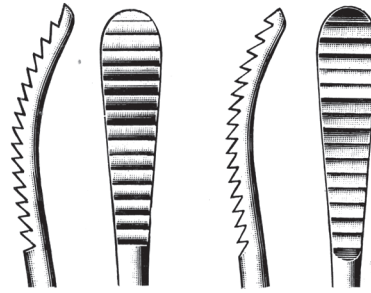

G46.0680.21

G46.0682.21

**AUFRICHT**  
21.0cm

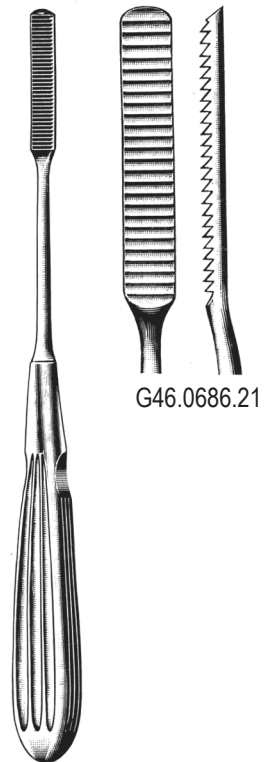

G46.0686.21

**COTTLE**  
21.0cm



# G46

Antrum und Nasenraspeln DE

Antrum and Nasal Rasps EN

Escofinas para el antro y nasales ES

المبارد الأنف AR



**WIENER**  
18.0cm

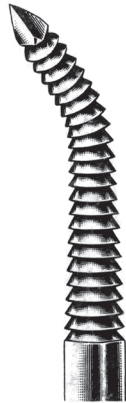

G46.0690.18



G46.0692.18

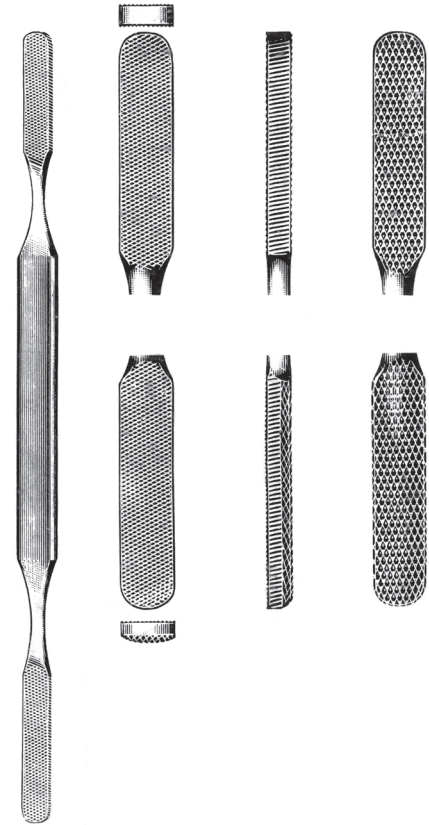

**FOMON**  
G46.0696.21 21.0cm

G46-026 G46.0696.21

DE Nasenhaken, Nasenhäkchen  
 EN Nasal Retractors, Nasal Hooks  
 ES Separadores nasales, ganchitos nasales  
 AR غاروالأنف المبارد



**KILNER**  
G46.0700.10 10.0cm



**CONVERSE**  
G46.0704.12 12.0cm



**AUFRICHT**  
G46.0710.16 16.0cm

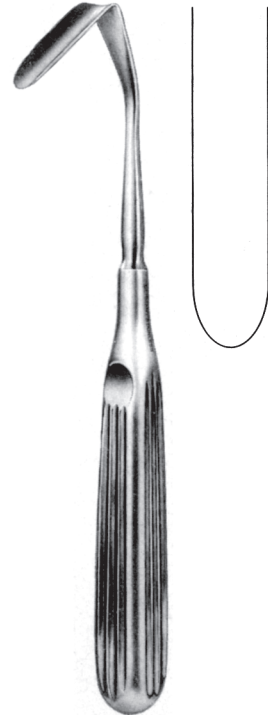

**AUFRICHT**  
G46.0712.19 19.0cm



15.0cm



**LANGE**  
G46.0720.22 22.0cm



**FOMON**  
G46.0724.17 17.0cm



**COTTLE**  
G46.0730.16 16.0cm



**FREER**  
G46.0740.15 15.0cm

G46.0740.15 **G46-027**





**OGURA**  
G46.0744.11 11.0cm



**COTTLE**  
G46.0750.11 11.0cm



**COTTLE**  
G46.0754.14 14.0cm



**COTTLE**  
15.0cm



G46.0760.14



G46.0762.01



G46.0762.02



**FOMON**  
G46.0766.16 16.0cm



**COTTLE-NEIVERT**  
G46.0770.20 20.0cm

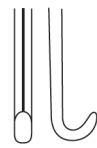

DE Septumnadeln, Nasenhaken  
 EN Septum Suture Needles, Nasal Retractors  
 ES Aguja para sutura del tabique nasal, separadores nasales  
 AR أبرخياطة الحاجز، الكامشات الأنف



G46.0774.01 G46.0774.02 G46.0774.03 G46.0774.04 G46.0774.05

G46.0774.06 G46.0774.07 G46.0774.08 G46.0774.09

**YANKAUER**



**COTTLE**  
G46.0780.14 14.0cm

**NEIVERT**  
G46.0784.16 16.0cm

**COTTLE**  
G46.0800.15 15.0cm

**COTTLE**  
G46.0802.15 15.0cm

**AUFRICHT**  
G46.0806.13 13.5cm

G46.0806.13 **G46-029**



# G46

Scharfe Löffel und Kuretten **DE**

Sharp Curettes **EN**

Ceretas cortantes **ES**

الملاعق حادة وكرتس **AR**

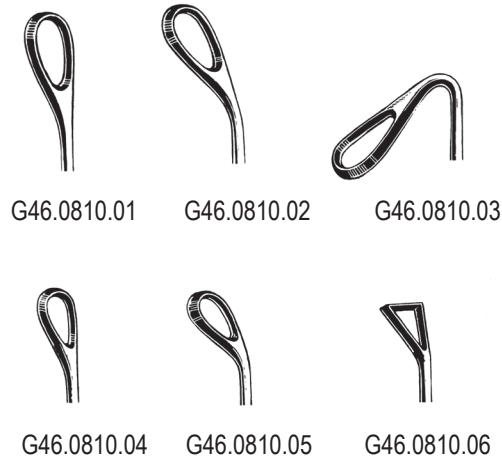

**COAKLEY**  
17.0cm



**MYLES**  
17.0cm

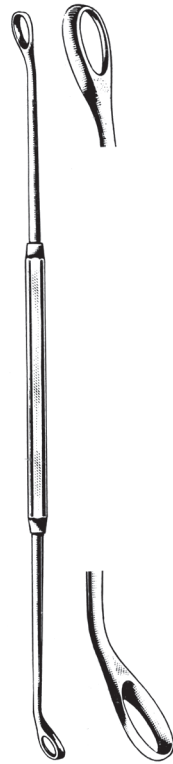

G46.0820.12 12.0cm

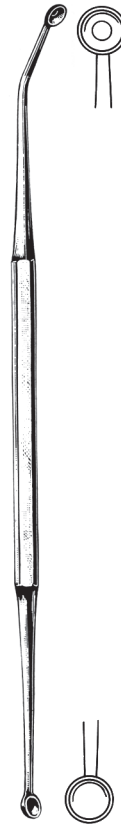

**PRATT**  
G46.0824.21 21.0cm

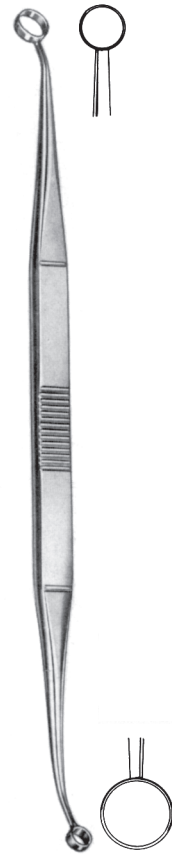

**FAULKNER**  
G46.0826.21 21.0cm

**G46-030** G46.0826.21

DE Instrumente zur Nasanplastik usw.  
EN Rhinoplastic Instruments etc.  
ES Instrumentos para la plastica nasal etc.  
AR تجميل الأنف الادوات الخ



**KRESSNER**  
G46.0830.20 20.0cm

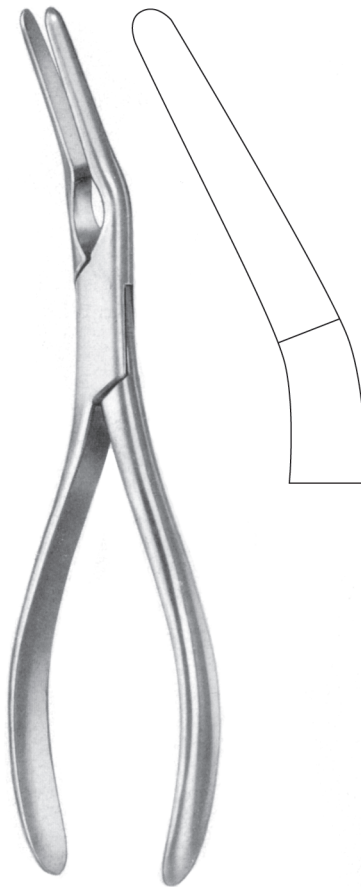

**ASCH**  
G46.0834.23 23.0cm



G46.0840.23  
straight



G46.0842.23  
left



G46.0844.23  
right



**COTTLE-WALSHAM**  
23.0cm





# G46

Ringmesser DE

Adenoid Currettes EN

Cuchillos para vegetaciones adenoides ES

المجارف الغدانيات AR



**BECKMANN** 22.0cm  
G46.0850.01 - G46.0850.06



**BECKMANN** 22.0cm  
G46.0852.01 - G46.0852.06

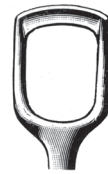

G46.0850.01  
G46.0852.01



G46.0850.02  
G46.0852.02



G46.0850.03  
G46.0852.03



G46.0850.04  
G46.0852.04

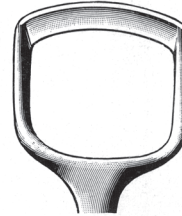

G46.0850.05  
G46.0852.05

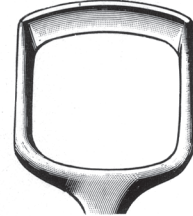

G46.0850.06  
G46.0852.06



**BECKMANN**  
22.0cm



G46.0856.01

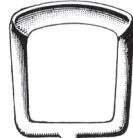

G46.0856.02

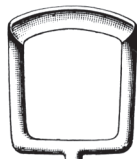

G46.0856.03

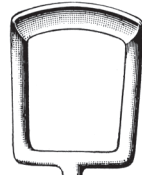

G46.0856.04

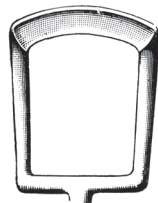

G46.0856.05



**ST.CLAIR-THOMSON**  
21.0cm



G46.0860.08  
8mm



G46.0860.10  
10mm



G46.0860.16  
16mm



G46.0860.18  
18mm



G46.0860.20  
20mm



G46.0860.22  
22mm

**G46-032** G46.0860.18



DE Kierfer hohlenhaken, Tonsillotome  
 EN Antrum Retractor, Adentomes  
 ES Separador para seno maxilar, Adenotomos  
 AR المجارف الغدانيات



**BRUENINGS-BRUNK**  
G46.0864.21 21.5cm

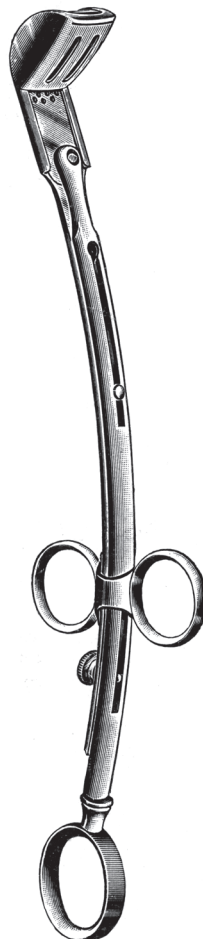

**LA FORCE**  
25.0cm

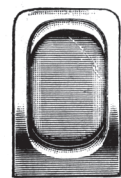

1

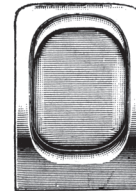

2

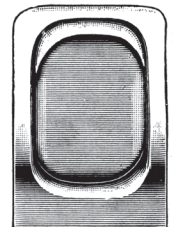

3

with unperforated blade  
 G46.0870.01 Fig. 1  
 G46.0870.02 Fig. 2  
 G46.0870.03 Fig. 3

spare blades  
 G46.0874.01 Fig. 1  
 G46.0874.02 Fig. 2  
 G46.0874.03 Fig. 3

with perforated blade  
 G46.0872.01  
 G46.0872.02  
 G46.0872.03

G46.0876.01  
 G46.0876.02  
 G46.0876.03



# G46

Antrum and Frontal Sinus Wash Cannulas, Wash Catheters, Probes **DE**

Antrum and Frontal Sinus Wash Cannulas, Wash Catheters, Probes **EN**

Canulas lavadoras para senos maxilar y frontal, cateteres lavadores, estiletos **ES**

الغارية وأمامي الجيوب الأنفية غسل قنية **AR**

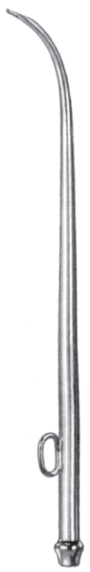

**SIEBENMANN**  
15.0cm

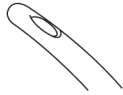

- G46.0880.15 1.5mm Ø
- G46.0880.17 1.7mm Ø
- G46.0880.20 2.0mm Ø
- G46.0880.25 2.5mm Ø
- G46.0880.30 3.0mm Ø



- G46.0882.15 1.5mm Ø
- G46.0882.17 1.7mm Ø
- G46.0882.20 2.0mm Ø
- G46.0882.25 2.5mm Ø
- G46.0882.30 3.0mm Ø



**GUILLEN**  
G46.0886.20 20.0cm



**RITTER-HALLE**  
G46.0890.25 2.5mm Ø  
G46.0890.30 3.0mm Ø  
G46.0890.45 4.5mm Ø

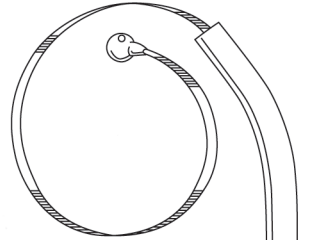

with screw



**BELLOCQ**  
G46.0894.14 14.0cm



**HAJEK**  
17.0cm  
G46.0900.15 1.5mm  
G46.0900.20 2.0mm



**MYLES**  
G46.0904.09 9.0cm  
G46.0904.11 11.5cm  
1.8mm Ø

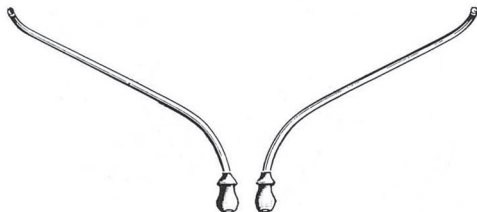

**HARTMANN**  
G46.0910.20 2.0mm G46.0912.20  
G46.0910.25 2.5mm G46.0912.25  
G46.0910.30 3.0mm G46.0912.30



**HARTMANN**  
G46.0916.20 2.0mm Ø  
G46.0916.25 2.5mm Ø  
G46.0916.30 3.0mm Ø



**EICKEN-KILLIAN**  
G46.0920.14 14.0cm, 3mm Ø



**EICKEN-KILLIAN**  
G46.0922.14 14.0cm, 3mm Ø



**KILLIAN**  
G46.0926.17 17.0cm, 1.5mm Ø

**G46-034** G46.0926.17