

- **Medical Equipment**
- **Surgical instruments**

Herz-und Gefäßchirurgie

DE	Herz-und Gefäßchirurgie
EN	Cardiovascular Surgery
ES	Cirugia cardiovascular
AR	جراحة القلب والأوعية الدموية

G34

PAGE 001 to 050



DE **Atrauma Pinzetten**
 EN **Atrauma Tissue Forceps**
 ES **Pinzas de diseccion atrauma**
 AR **الملقط النسيج لارضي**

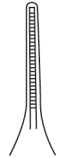

1.5mm

G34.0010.12 12.5cm

DEBAKEY-ADSON



1.0mm

G34.0014.15 15.0cm
 G34.0014.18 18.0cm

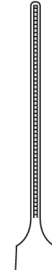

1.2mm

G34.0016.15 15.0cm
 G34.0016.18 18.0cm
 G34.0016.24 24.0cm

DEBAKEY-GERALD

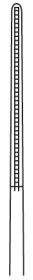

1.0mm

G34.0020.18 18.0cm

DEBAKEY-CUSHING



1.0mm

G34.0024.15 15.0cm G34.0026.15
 G34.0024.19 19.0cm G34.0026.19
 G34.0024.24 24.0cm G34.0026.24

DEBAKEY-DIETRICH



1.5mm



1.0mm

G34.0030.15 15.0cm
 G34.0030.19 19.0cm
 G34.0030.24 24.0cm

DEBAKEY-LIGHT

G34.0030.24 **G34-001**



G34

Atrauma Pinzetten DE

Atrauma Tissue Forceps EN

Pinzas de diseccion atrauma ES

الملقط النسيج لارضي AR

ALSO AVAILABLE IN TITANIUM



DE BAKEY

- G34.0034.16 16.0cm
- G34.0034.20 20.0cm
- G34.0034.24 24.0cm
- G34.0034.30 30.0cm

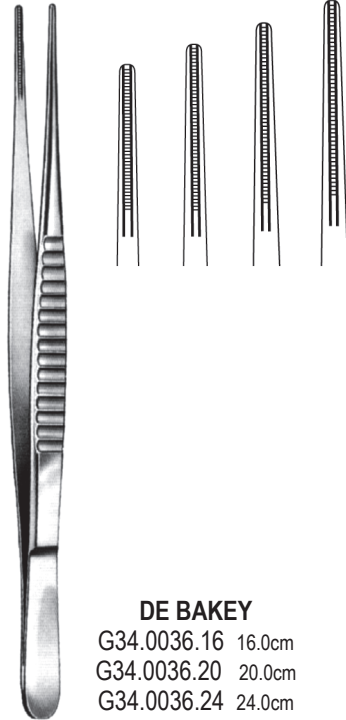

DE BAKEY

- G34.0036.16 16.0cm
- G34.0036.20 20.0cm
- G34.0036.24 24.0cm
- G34.0036.30 30.0cm



DE BAKEY

- G34.0038.16 16.0cm
- G34.0038.20 20.0cm
- G34.0038.24 24.0cm
- G34.0038.30 30.0cm

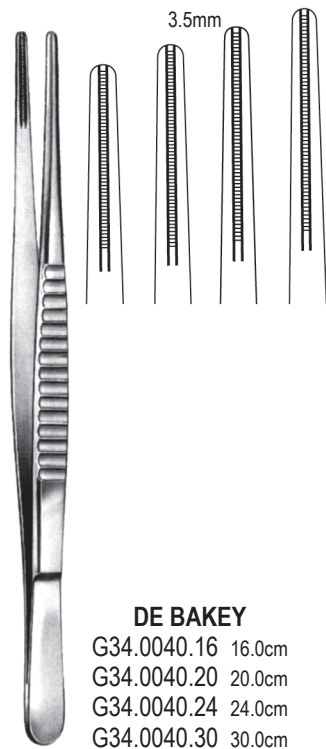

DE BAKEY

- G34.0040.16 16.0cm
- G34.0040.20 20.0cm
- G34.0040.24 24.0cm
- G34.0040.30 30.0cm

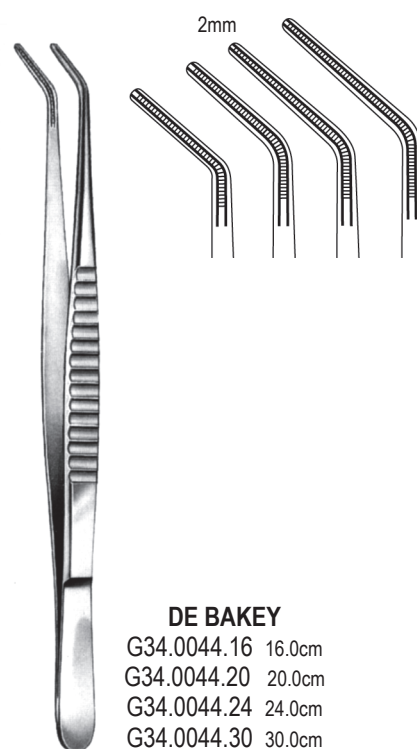

DE BAKEY

- G34.0044.16 16.0cm
- G34.0044.20 20.0cm
- G34.0044.24 24.0cm
- G34.0044.30 30.0cm



DE BAKEY

- G34.0046.16 16.0cm
- G34.0046.20 20.0cm
- G34.0046.24 24.0cm
- G34.0046.30 30.0cm

G34-002 G34.0046.30



- DE Atrauma Bulldogklemmen
- EN Atrauma Bulldog Clamps
- ES Atrauma clamps bulldog
- AR الاستيطاني المشابك بلدغ

ALSO AVAILABLE IN TITANIUM



MINI-GLOVER

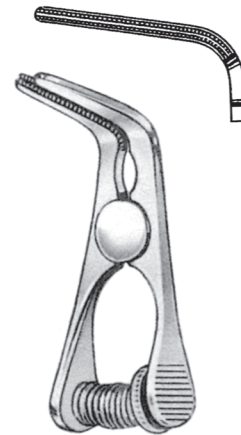
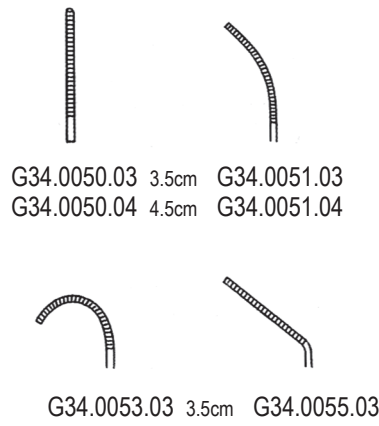

GLOVER
G34.0060.05 5.0cm

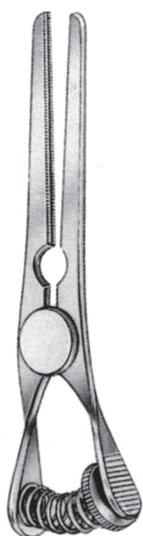

**GLOVER
(DELICATE)**

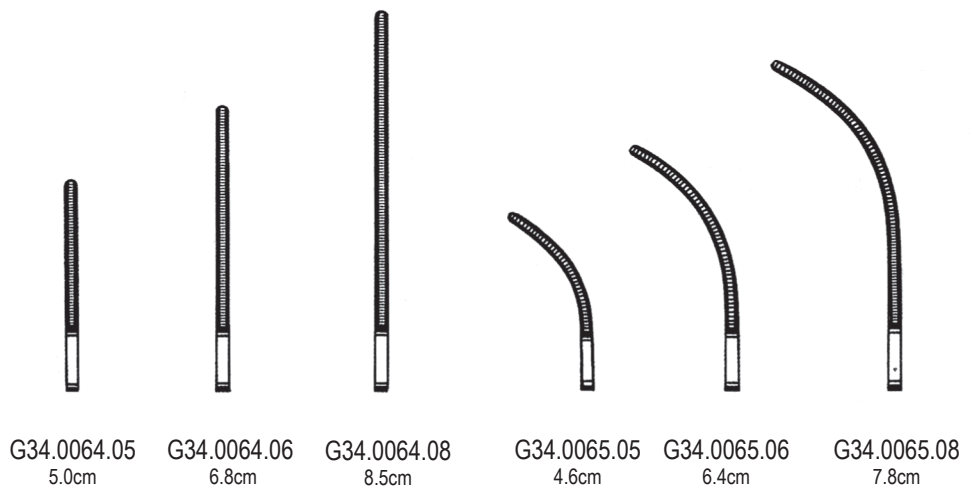

G34.0065.08 **G34-003**



G34

Atrauma Bulldogklemmen DE

Atrauma Bulldog Clamps EN

Atrauma clamps bulldog ES

الاستيطاني المشابك بلدغ AR

ALSO AVAILABLE IN TITANIUM

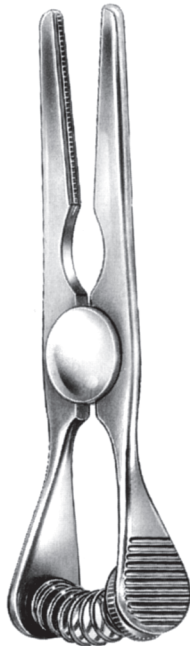

GLOVER



G34.0070.07
7.0cm



G34.0070.08
8.0cm



G34.0070.09
9.0cm



G34.0070.11
11.0cm



GLOVER



G34.0071.06
6.0cm



G34.0071.07
7.5cm



G34.0071.08
8.5cm



G34.0071.11
10.5cm

G34-004 G34.0071.11



- DE Atrauma Bulldogklemmen
- EN Atrauma Bulldog Clamps
- ES Atrauma clamps bulldog
- AR الاستيطاني المشابك بلدغ

ALSO AVAILABLE IN TITANIUM



DE BAKEY



G34.0074.07
7.5cm



G34.0074.08
8.5cm



G34.0074.10
10.5cm



G34.0074.12
12.0cm



DE BAKEY

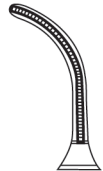

G34.0075.07
7.0cm

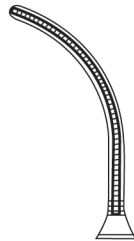

G34.0075.08
8.0cm

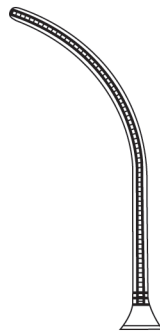

G34.0075.10
10.0cm

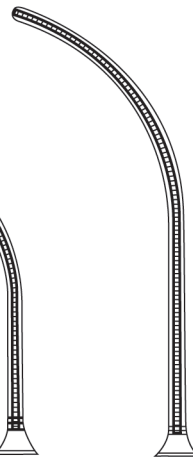

G34.0075.11
11.5cm



G34.0080.23 23.0cm

G34.0080.23 **G34-005**



G34

Atrauma Bulldogklemmen DE

Atrauma Bulldog Clamps EN

Atrauma clamps bulldog ES

الاستيطاني المشابك بلدغ AR

ALSO AVAILABLE IN TITANIUM

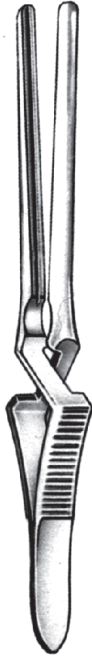

GREGORY SOFT

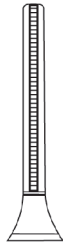

G34.0084.09
9.0cm

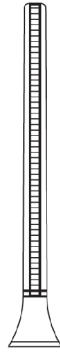

G34.0084.11
11.0cm



GREGORY SOFT



G34.0085.09
9.0cm

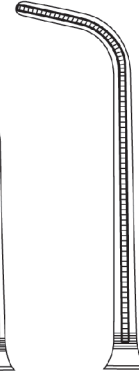

G34.0085.11
11.0cm



GREGORY SOFT
11.0cm



G34.0090.01

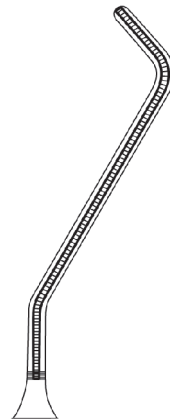

G34.0090.02



SANTULLI
G34.0094.07 7.0cm

G34-006 G34.0094.07



- DE Atrauma Bulldogklemmen
- EN Atrauma Bulldog Clamps
- ES Atrauma clamps bulldog
- AR الاستيطاني المشابك بلدغ

ALSO AVAILABLE IN TITANIUM



DE BAKEY-SATINSKY
G34.0100.07 7.0cm

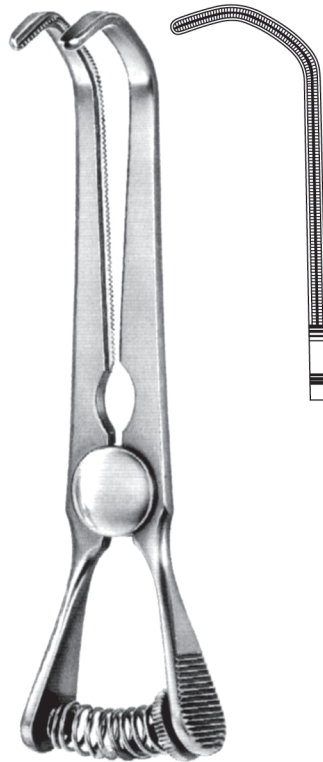

DE BAKEY-SATINSKY
G34.0100.10 10.0cm



DE BAKEY-CAROTIS
G34.0104.09 9.0cm

G34.0104.09 **G34-007**



G34

Atrauma Arterienklemmen **DE**
Atrauma Hemostatic Forceps **EN**
Atrauma hemostaticas pinzas **ES**
الاستيطاني الماقت مرقي **AR**

ALSO AVAILABLE IN TITANIUM

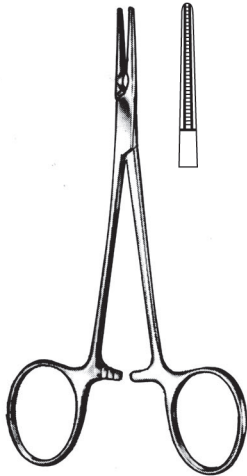

MOSQUITO
G34.0110.12 12.0cm



MOSQUITO
G34.0111.12 12.0cm

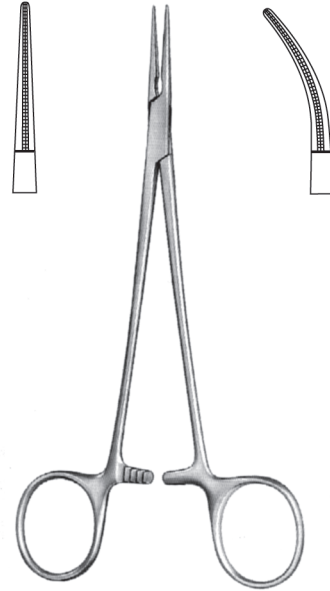

DE BAKEY-MOSQUITO
G34.0120.15 15.0cm G34.0121.15

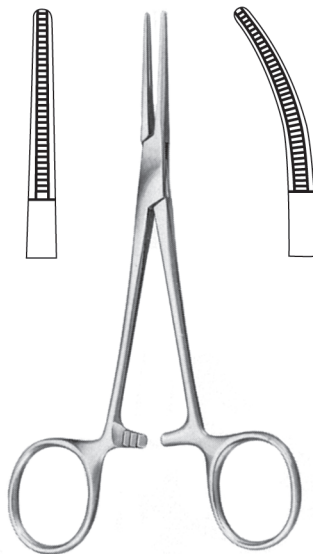

DE BAKEY-KELLY
G34.0124.14 14.0cm G34.0125.14

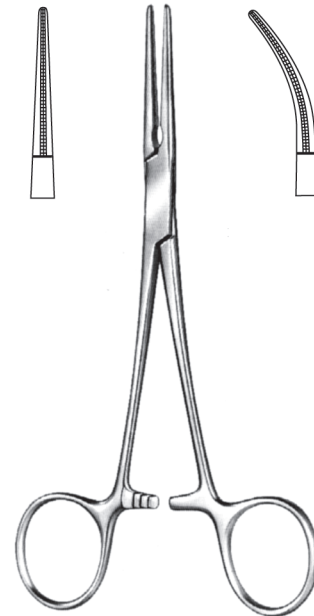

DE BAKEY-RAKIN
G34.0130.16 16.0cm G34.0131.16

G34-008 G34.0131.16



- DE **Atrauma Cardiovascular-Klemmen**
- EN **Atrauma Cardiovascular Forceps**
- ES **Atrauma pinzas-clamps cardiovasculares**
- AR **الاستيطاني القلب والأوعية الدموية الماقت**

ALSO AVAILABLE IN TITANIUM



DE BAKAY
G34.0134.10 10.0cm



DE BAKAY
G34.0140.13 13.0cm



DE BAKAY
G34.0150.12 12.0cm

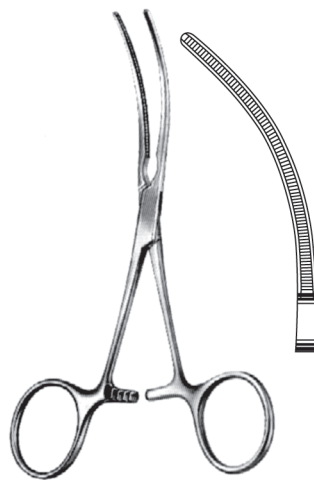

DE BAKAY
G34.0152.11 11.0cm

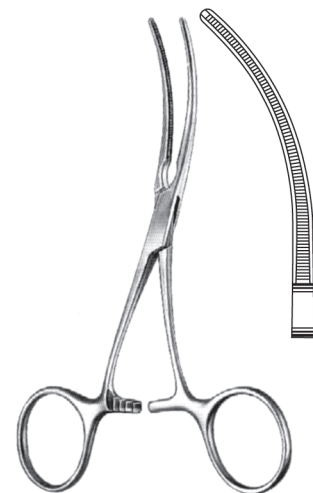

DE BAKAY
G34.0154.12 12.0cm

G34.0154.12 **G34-009**



G34

Atrauma Cardiovascular-Klemmen DE

Atrauma Cardiovascular Forceps EN

Atrauma pinzas-clamps cardiovasculares ES

الاستيطاني القلب والأوعية الدموية الماقت AR

ALSO AVAILABLE IN TITANIUM



HUSFELDT
G34.0160.17 17.0cm

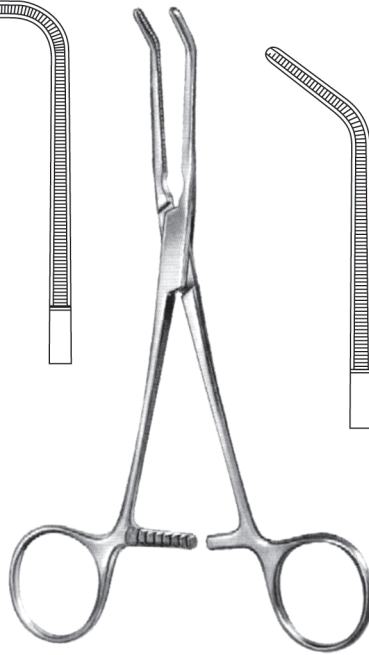

HUSFELDT
G34.0162.17 17.0cm



HUSFELDT
G34.0164.18 18.0cm

G34-010 G34.0164.18

DE **Atrauma Cardiovascular-Klemmen**
 EN **Atrauma Cardiovascular Forceps**
 ES **Atrauma pinzas-clamps cardiovasculares**
 AR **الاستيطاني القلب والأوعية الدموية الماقت**

ALSO AVAILABLE IN TITANIUM

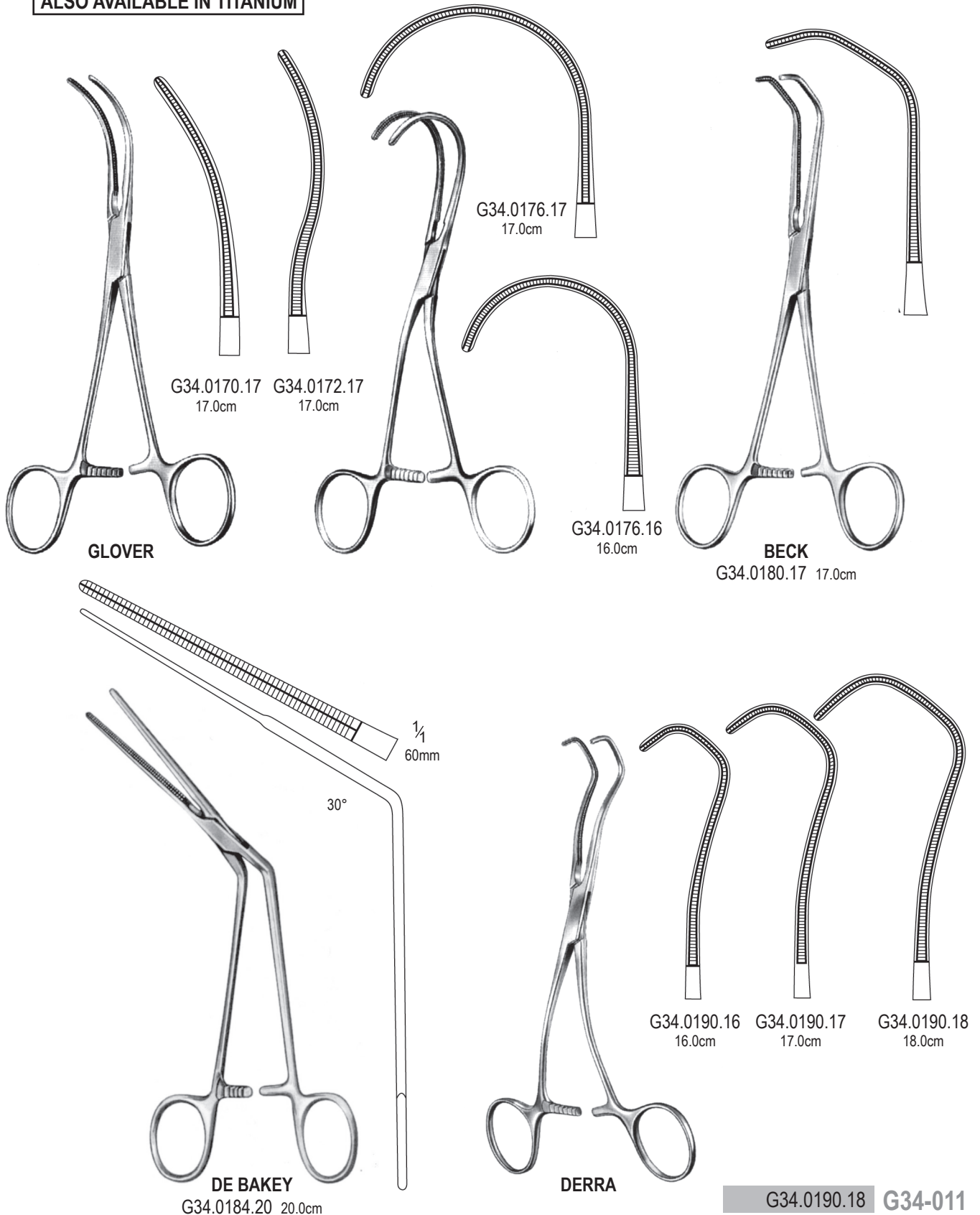

G34

Atrauma Cardiovascular-Klemmen DE

Atrauma Cardiovascular Forceps EN

Atrauma pinzas-clamps cardiovasculares ES

الاستيطاني القلب والأوعية الدموية الماقت AR

ALSO AVAILABLE IN TITANIUM

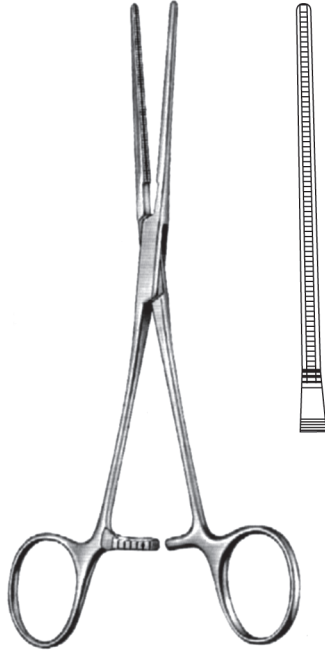

DE BAKEY
G34.0194.17 17.0cm

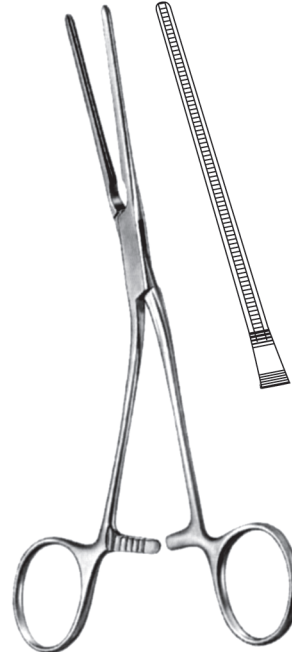

DE BAKEY
G34.0200.17 17.0cm



DE BAKEY
G34.0204.16 16.0cm

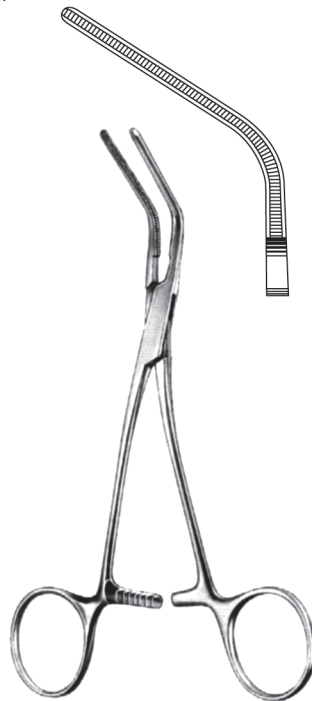

DE BAKEY
G34.0210.15 15.0cm



DE BAKEY
G34.0214.15 15.0cm

G34-012 G34.0214.15



- DE Atrauma Arterienklemmen
- EN Atrauma Hemostatic Forceps
- ES Atrauma hemostaticas pinzas
- AR الاستيطاني الماقت مرقي

ALSO AVAILABLE IN TITANIUM

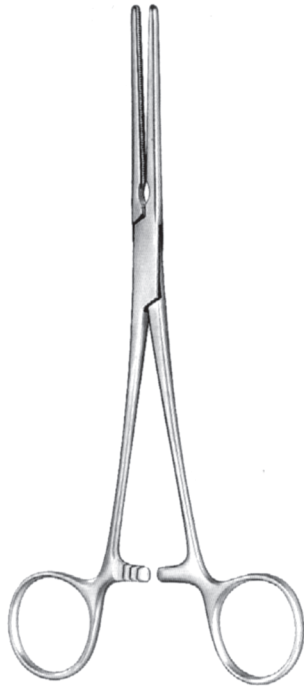

DE BAKEY-PEAN

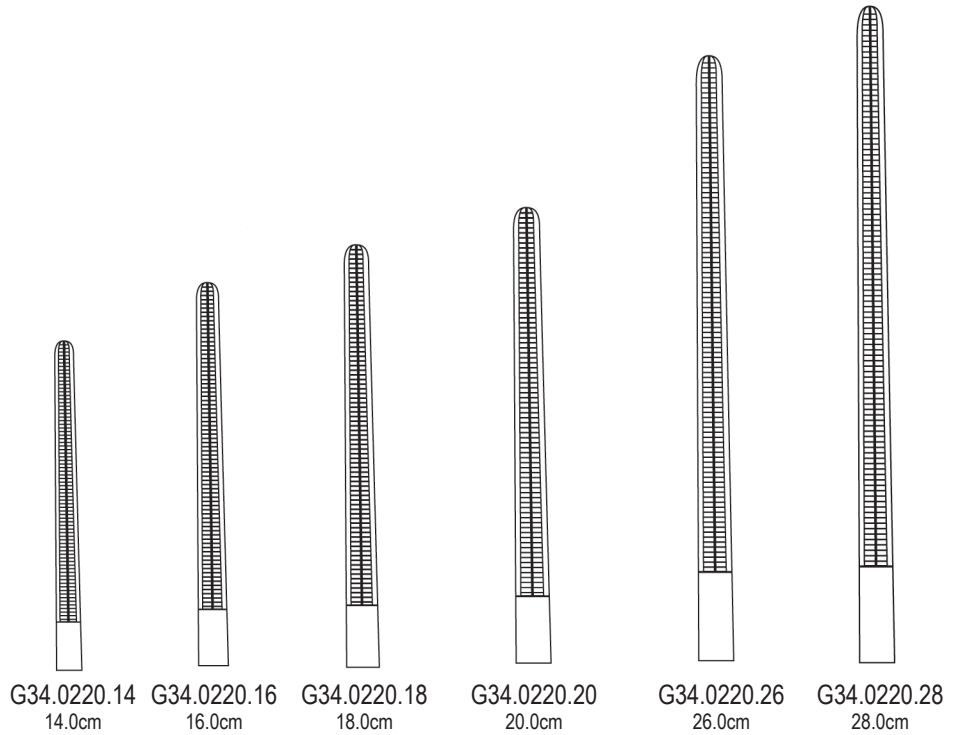

DE BAKEY-PEAN

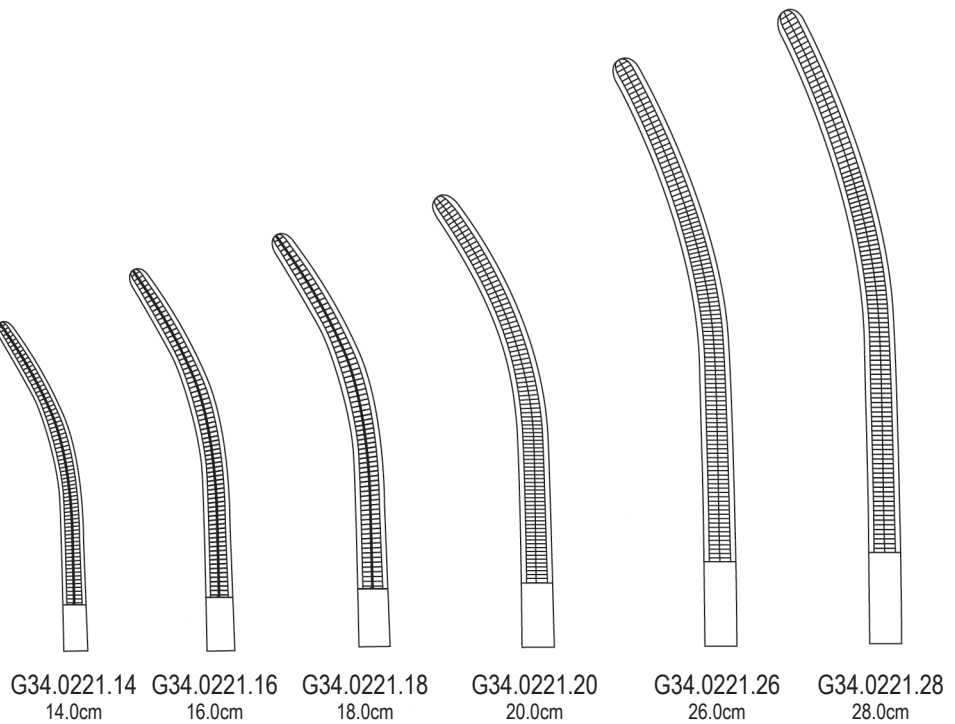

G34.0221.28 **G34-013**



G34

Atrauma Cardiovascular-Klemmen DE

Atrauma Cardiovascular Forceps EN

Atrauma pinzas-clamps cardiovasculares ES

الاستيطاني القلب والأوعية الدموية الماقت AR

ALSO AVAILABLE IN TITANIUM



LAMBERT-KEY

G34.0226.21
21.0cm

G34.0226.22
22.0cm

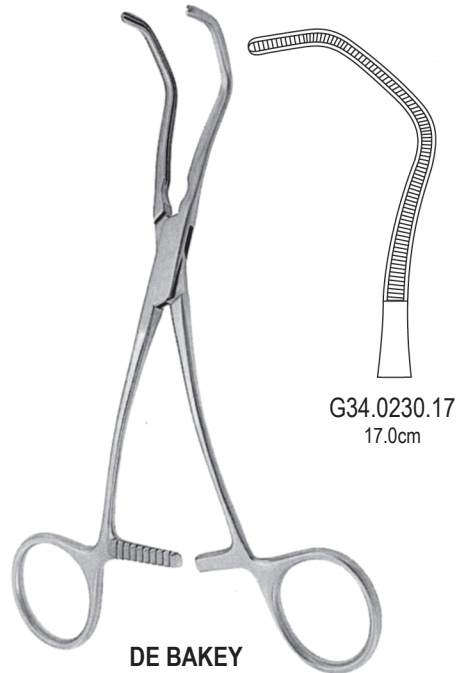

DE BAKEY

G34.0230.17
17.0cm

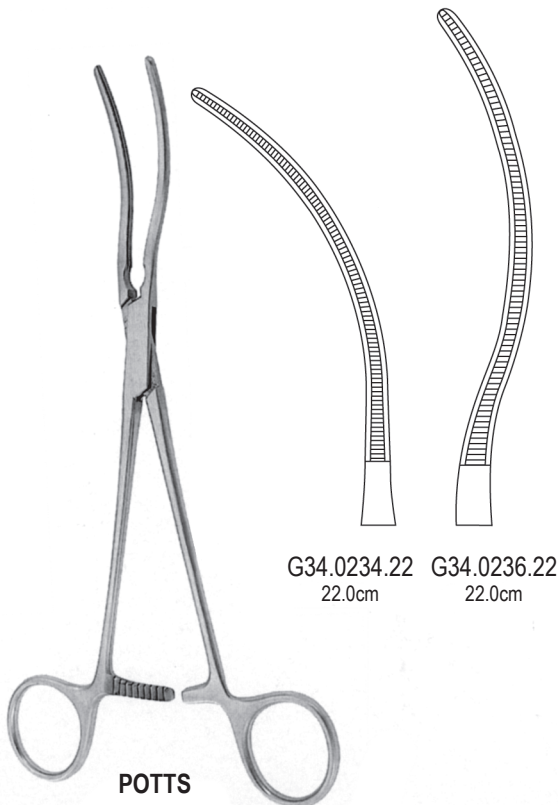

POTTS

G34.0234.22
22.0cm

G34.0236.22
22.0cm

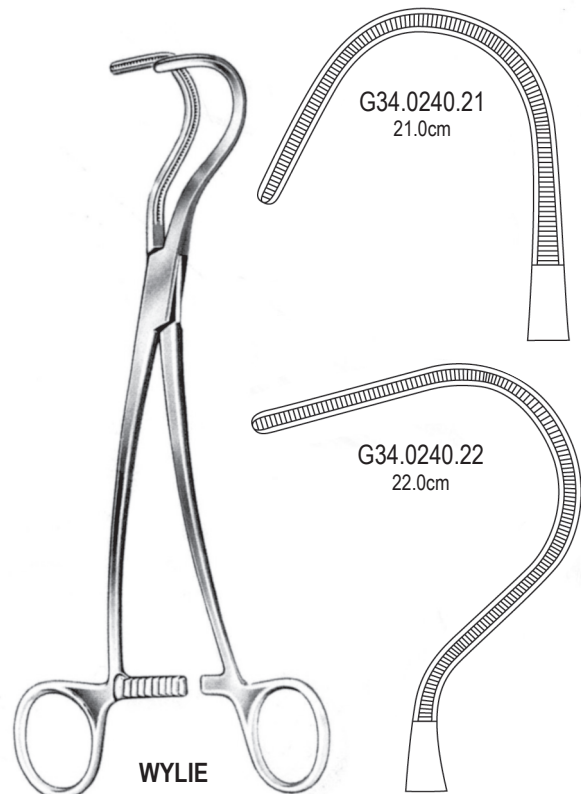

WYLIE

G34.0240.21
21.0cm

G34.0240.22
22.0cm

G34-014 G34.0240.22



DE **Atruma Cardiovascular-Klemmen**
EN **Atrauma Cardiovascular Forceps**
ES **Atrauma pinzas-clamps cardiovasculares**
AR **الاستيطاني القلب والأوعية الدموية الماقت**

ALSO AVAILABLE IN TITANIUM

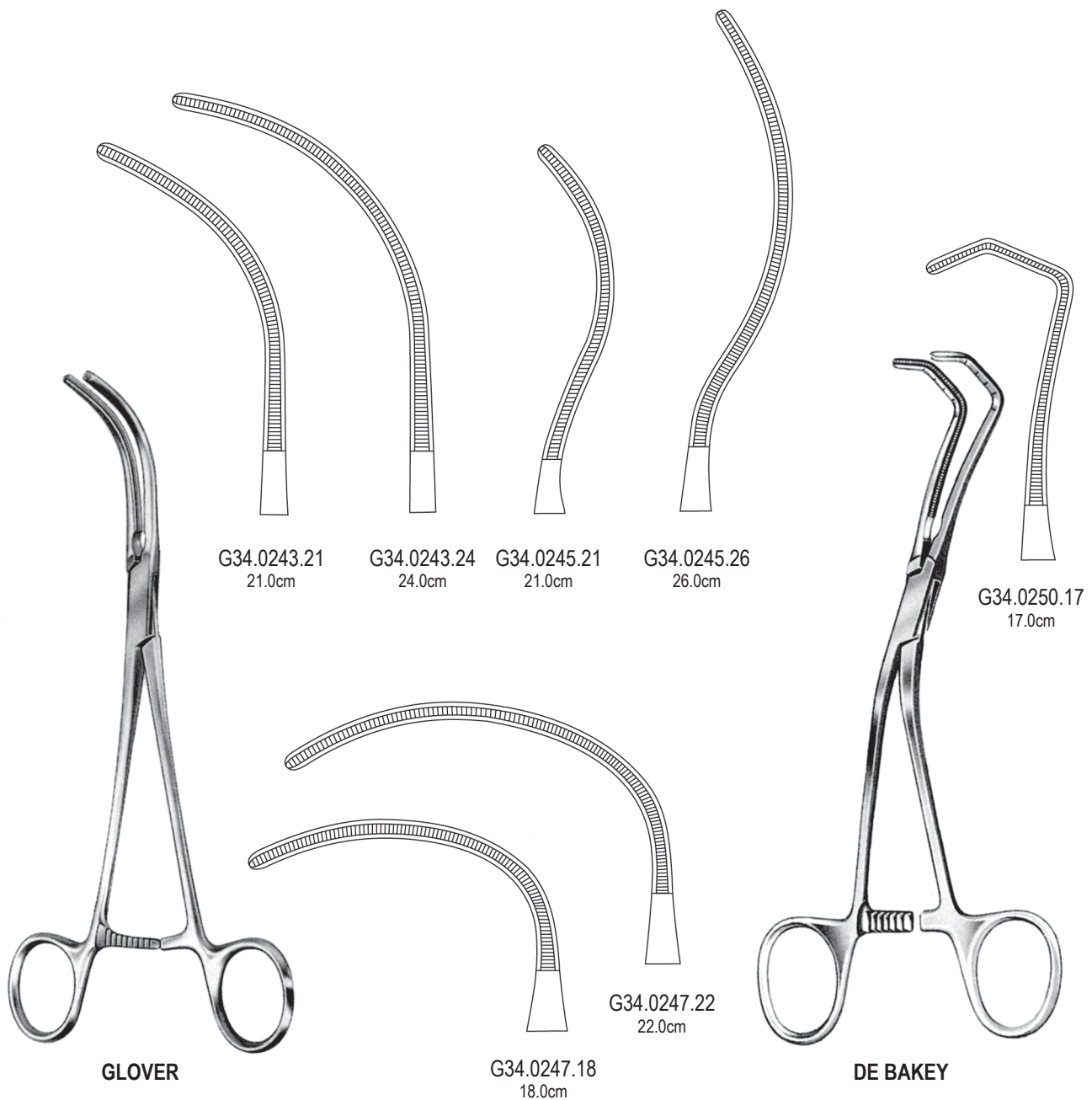

G34

Atrauma Cardiovascular-Klemmen DE

Atrauma Cardiovascular Forceps EN

Atrauma pinzas-clamps cardiovasculares ES

الاستيطاني القلب والأوعية الدموية الماقت AR

ALSO AVAILABLE IN TITANIUM



DE BAKEY-REYNOLDS

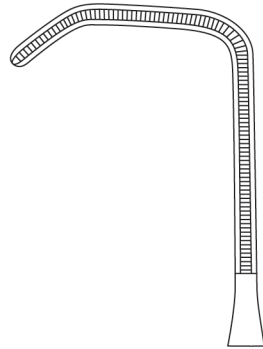

G34.0254.16
16.5cm

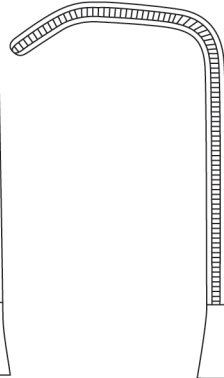

G34.0256.16
16.5cm

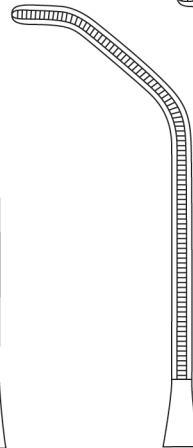

G34.0254.18
18.0cm

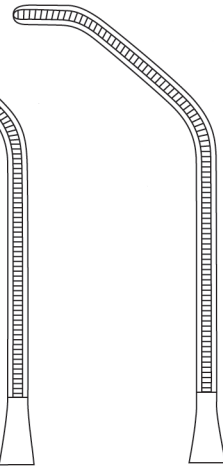

G34.0256.18
18.0cm

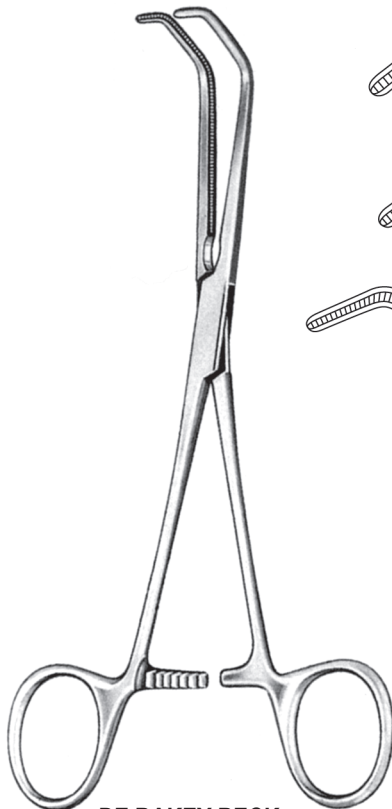

DE BAKEY-BECK

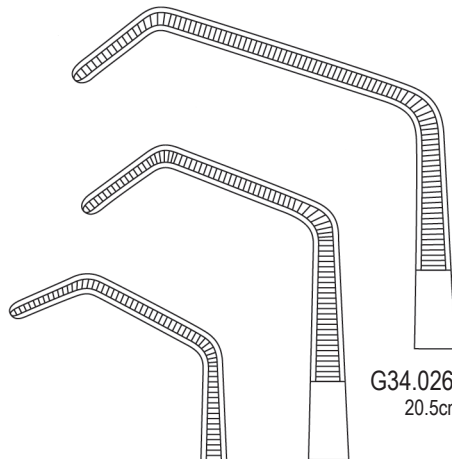

G34.0260.19
19.5cm

G34.0260.20
20.5cm

G34.0260.16
16.5cm



G34.0264.27
27.0cm



LIDDLE

G34-016 G34.0264.27



DE Aorta-Aneurysmaklemmen

EN Aortic Aneurysm Clamps

ES Pinzas - clamps para aneurisma

AR المشابك الأبهري

ALSO AVAILABLE IN TITANIUM

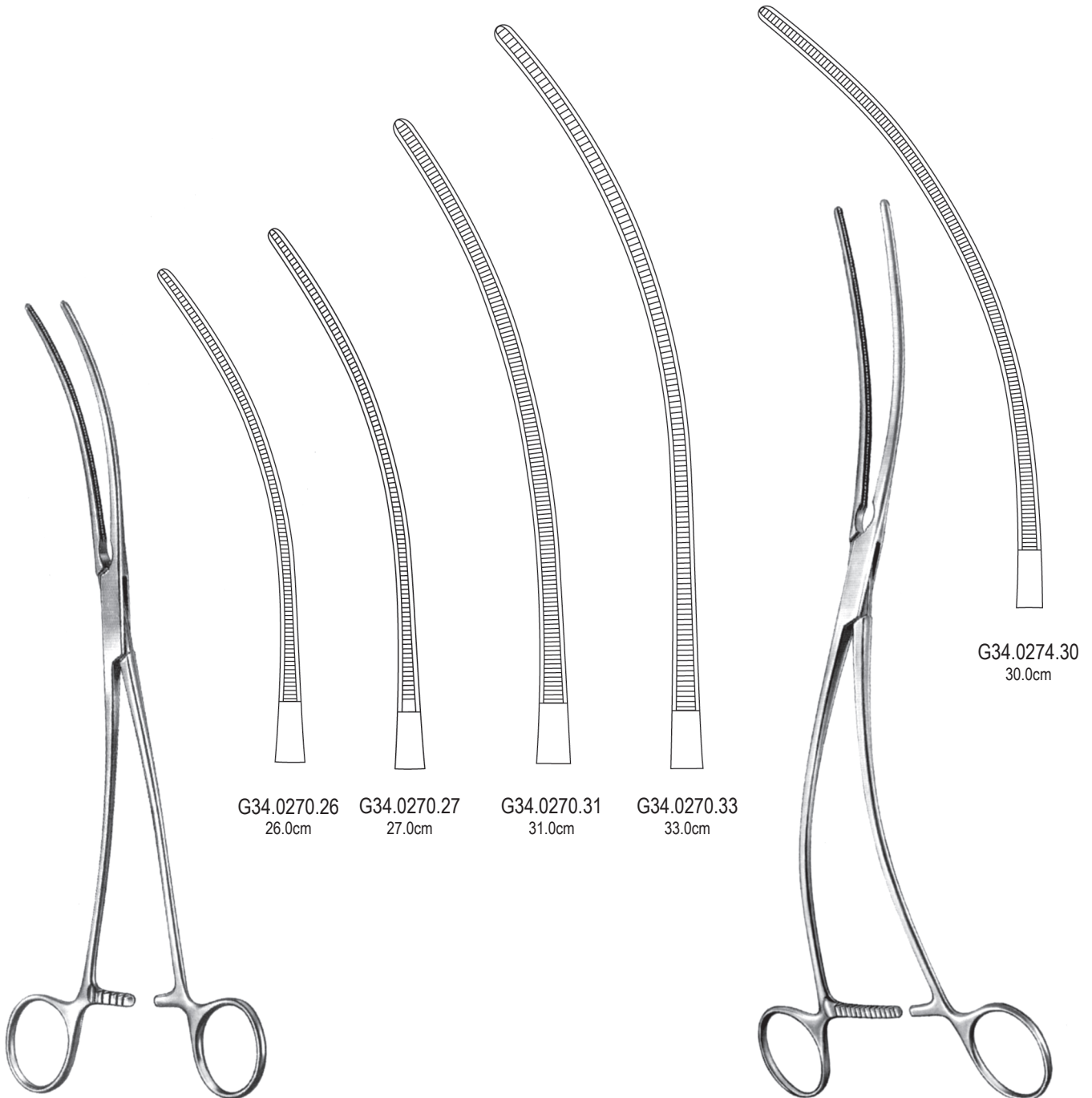

G34.0270.26
26.0cm

G34.0270.27
27.0cm

G34.0270.31
31.0cm

G34.0270.33
33.0cm

G34.0274.30
30.0cm

G34.0270.30 G34-017

G34

Aorta-Aneurysmaklemmen DE

Aortic Aneurysm Clamps EN

Pinzas-clamps para aneurisma ES

المشابك الأبهر AR

ALSO AVAILABLE IN TITANIUM

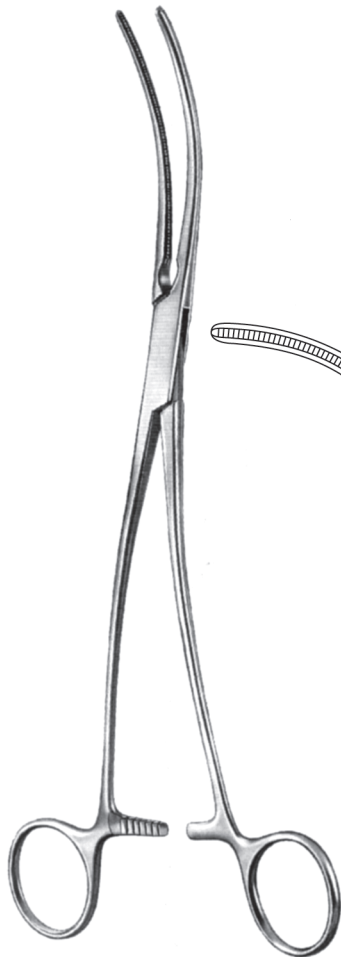

DE BAKEY-BAHNSON



G34.0280.23
23.0cm



G34.0280.24
24.0cm

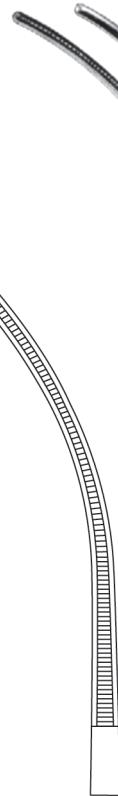

G34.0280.25
25.0cm



DE BAKEY

G34.0284.28
28.0cm

G34-018 G34.0284.28



- DE Aortaklemmen
- EN Aortic Clamps
- ES Pinzas-clamps para aorta
- AR المشابك الأبهري

ALSO AVAILABLE IN TITANIUM



OCHSNER
G34.0290.23 23.5cm
G34.0290.26 26.0cm



DIETRICH
G34.0294.21 21.0cm

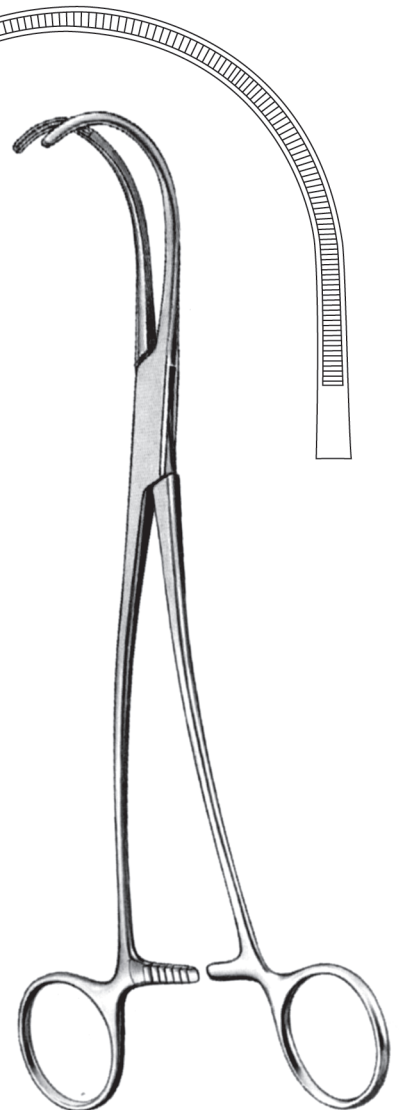

DE BAKEY
G34.0300.26 26.0cm

G34.0300.26 **G34-019**



G34

Aortaklemmen DE
Aortic Clamps EN
Piznas-clamps para aorta ES
المشابك الأبهر AR

ALSO AVAILABLE IN TITANIUM

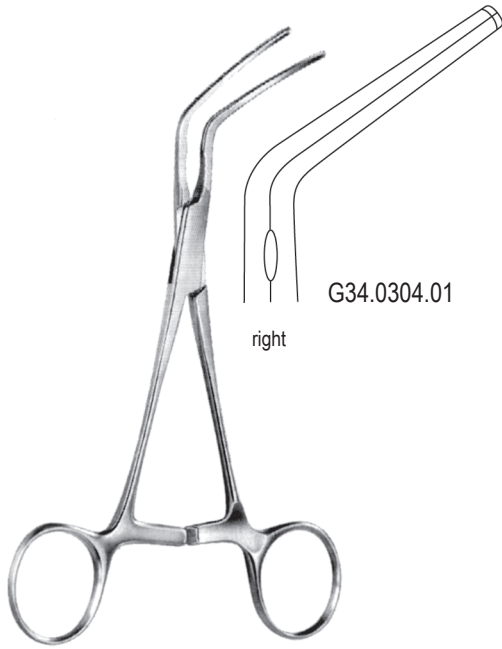

G34.0304.01

right

SUBRAMANIAN
16.0cm

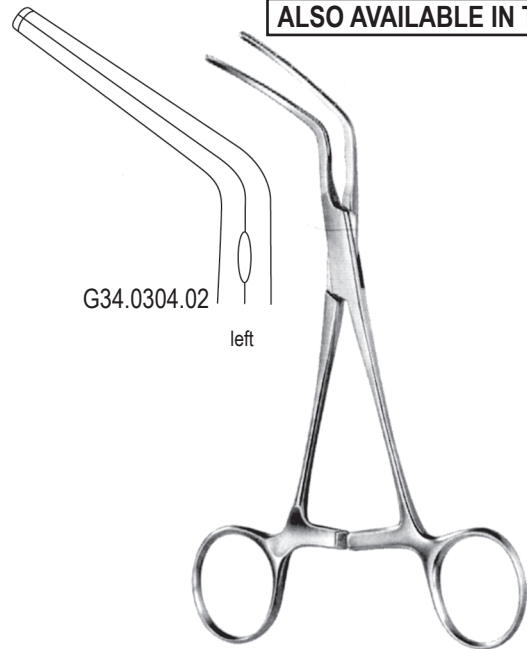

G34.0304.02

left

SUBRAMANIAN
16.0cm

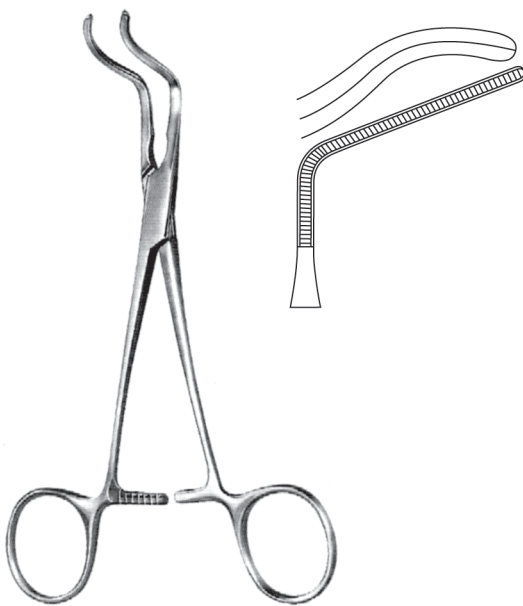

SUBRAMANIAN-MINIATURE
G34.0310.15 15.5cm

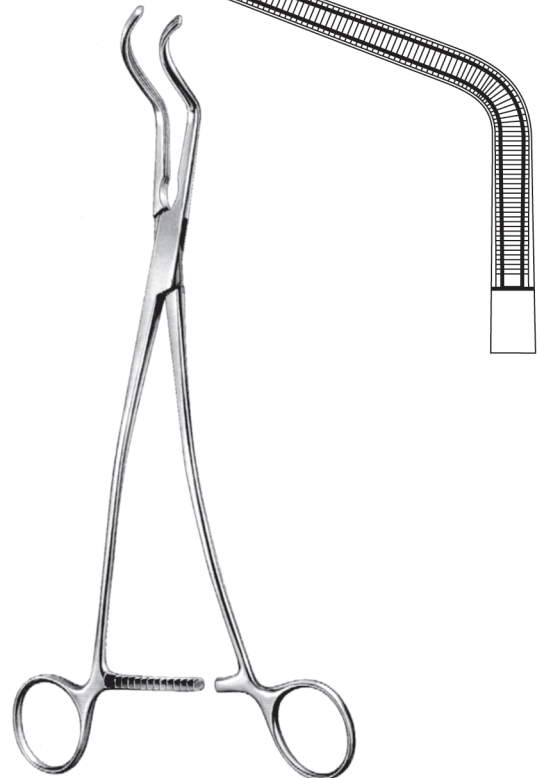

DE BAKEY
G34.0314.27 27.0cm

G34-020 G34.0314.27



- DE Aortaklemmen
- EN Aortic Clamps
- ES Pinzas-clamps para aorta
- AR المشابك الأبهري

ALSO AVAILABLE IN TITANIUM

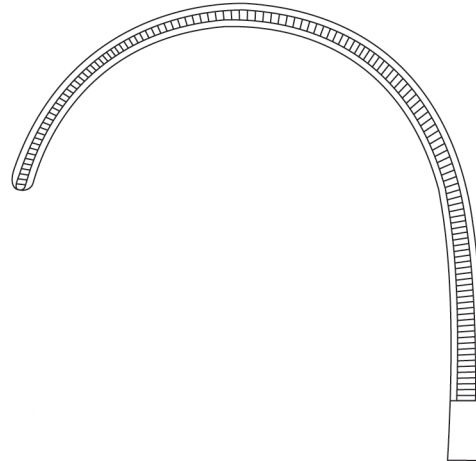
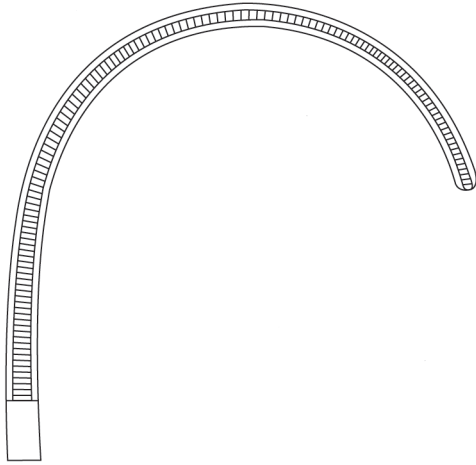

WEBER
G34.0320.01 26.0cm



WEBER
G34.0320.02 26.0cm

G34.0320.02 **G34-021**



G34

Aortaklemmen DE
Aortic Clamps EN
Piznas-clamps para aorta ES
المشابك الأبهر AR

ALSO AVAILABLE IN TITANIUM

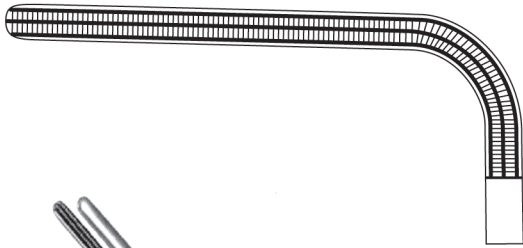

G34.0324.18
18.0cm

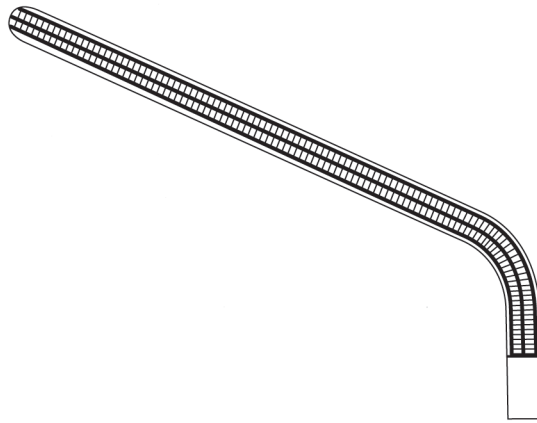

G34.0324.20
20.0cm



MORRIS - DE BAKEY

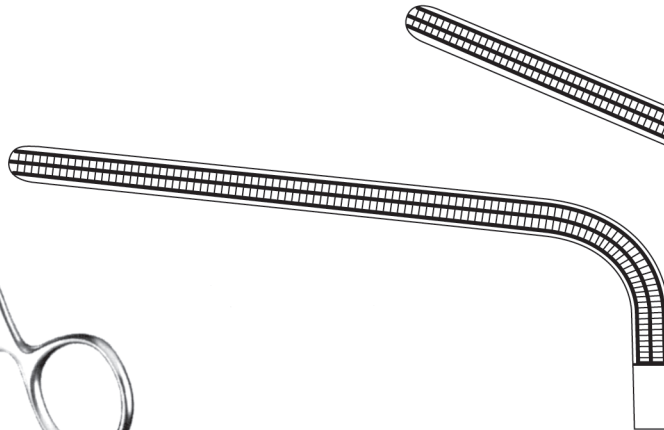

G34.0324.23
23.0cm

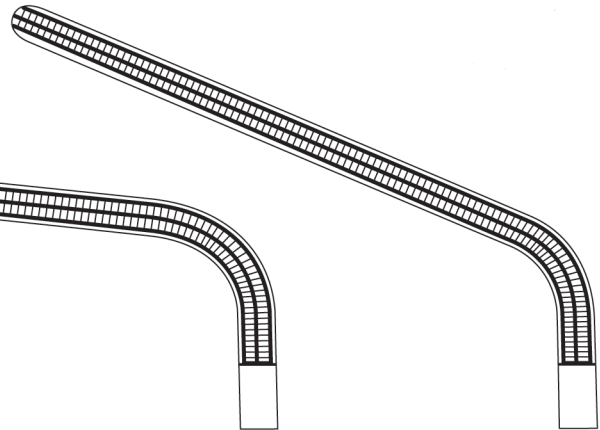

G34.0324.25
25.0cm

G34-022 G34.0324.25



DE Tangentialklemmen
EN Tangential Occlusion Clamps
ES Pinzas-clamps para oclusion tangencial
AR المشبك الأنسداد عرضية

ALSO AVAILABLE IN TITANIUM



DE BAKEY
SATINSKY



SATINSKY

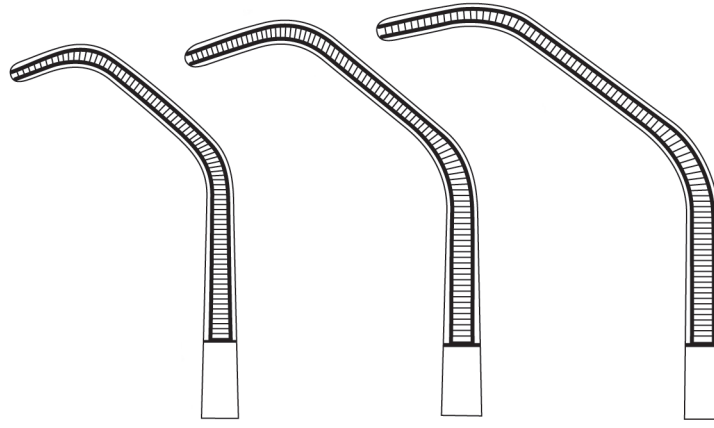
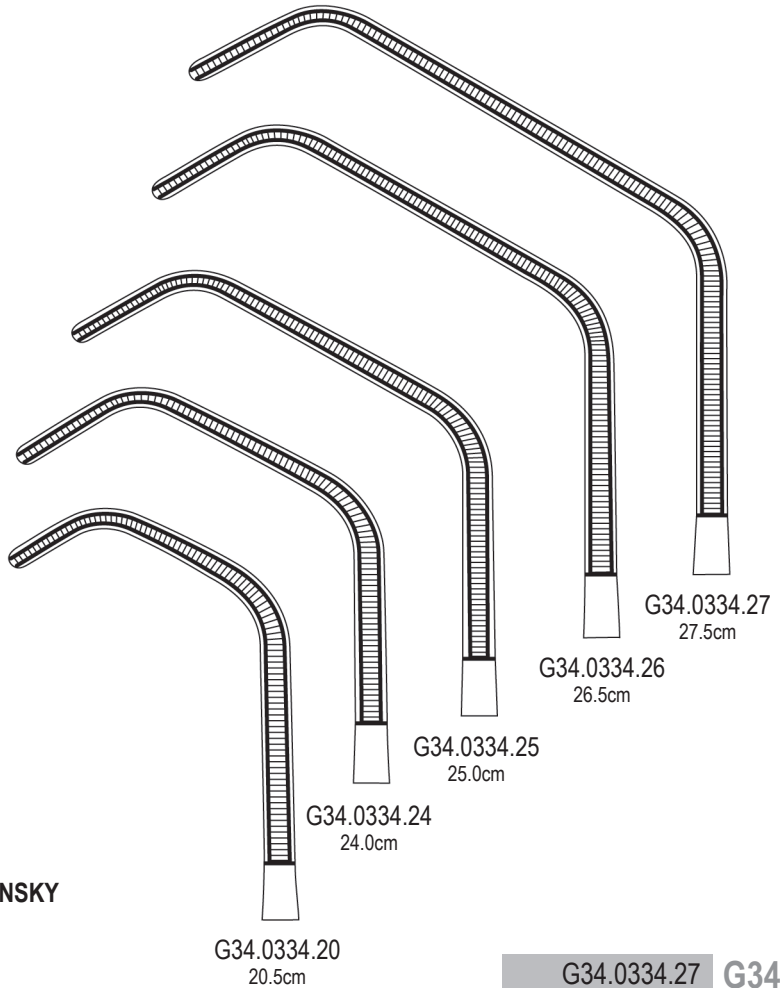

Fig.1 G34.0330.23 23.5cm
Fig.2 G34.0330.24 24.0cm
Fig.3 G34.0330.25 25.0cm



G34.0334.20 20.5cm
G34.0334.24 24.0cm
G34.0334.25 25.0cm
G34.0334.26 26.5cm
G34.0334.27 27.5cm
G34.0334.27 G34-023



G34

Coarctationsklemmen, Nieren-Arterienklemme **DE**

Coarctation forceps, Renal Artery Clamp **EN**

Pinzas-clamps para coarctacion, pinzas-clamps para arteria renal **ES**

الملقط تضيق، المشبك الشريان الكلوي **AR**

ALSO AVAILABLE IN TITANIUM

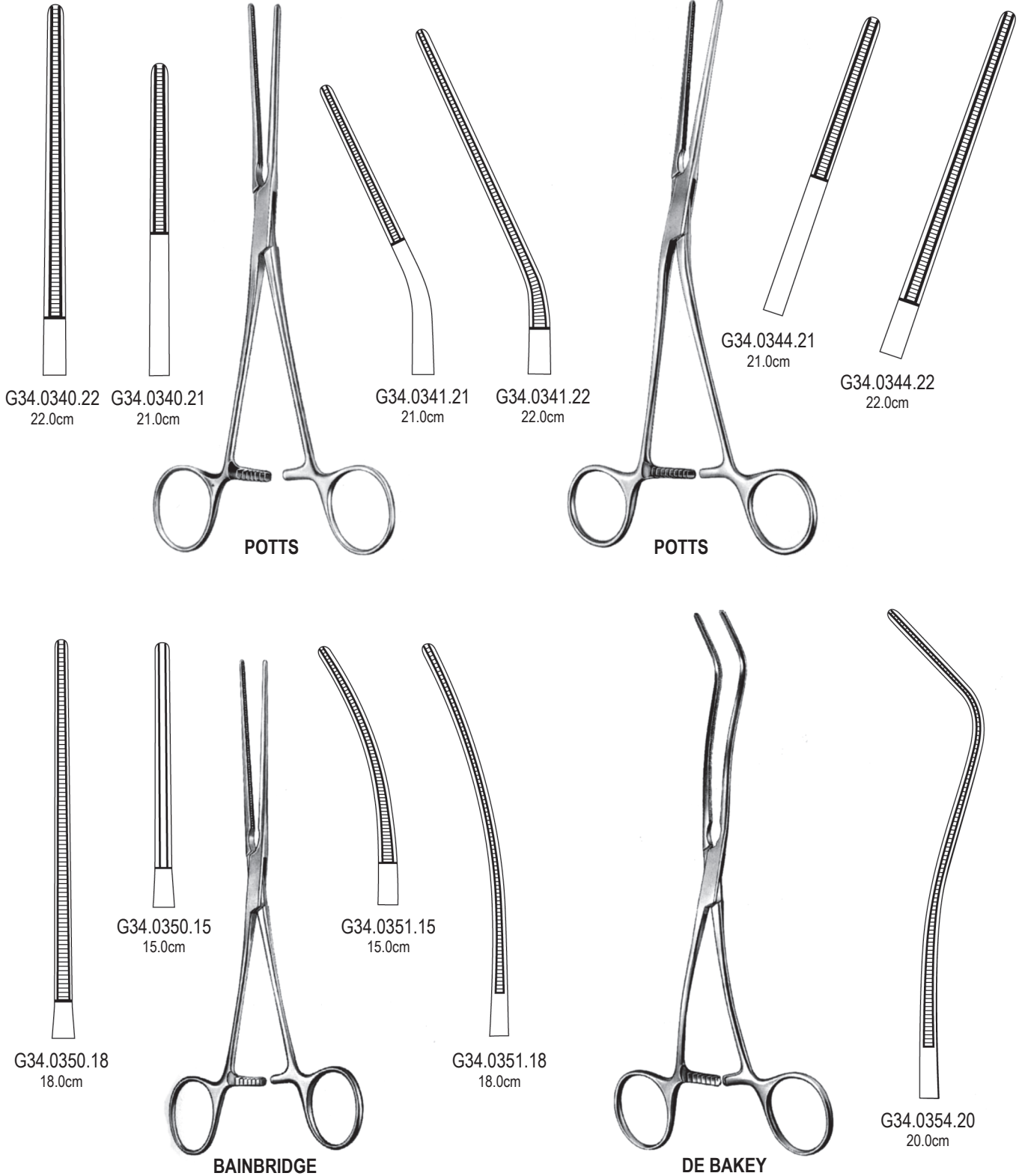

G34-024 G34.0354.20



- DE Profundaklemmen, Peripheral-Gafaßklemmen
 EN Profunda Clamps, Peripheral Vascular Clamps
 ES Pinzas-clamps para la profunda, pinzas-clamps para vasos perifericos
 AR المشابك هوندا، المشابك الأوعية الدموية الطرفية

ALSO AVAILABLE IN TITANIUM



GREGORY

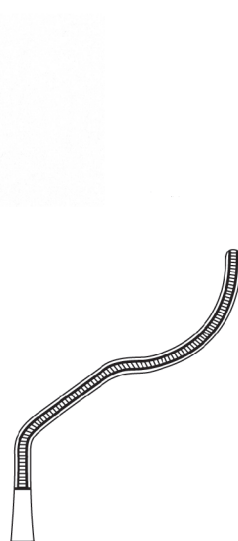

G34.0360.14
14.0cm

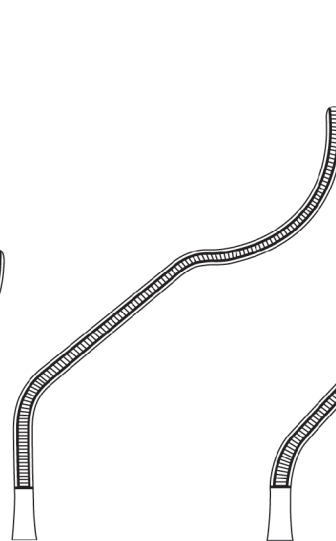

G34.0360.16
16.0cm

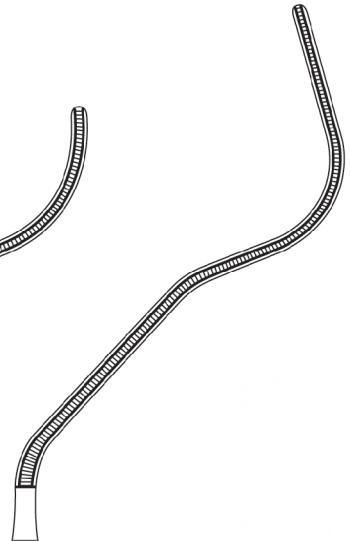

G34.0360.18
18.0cm

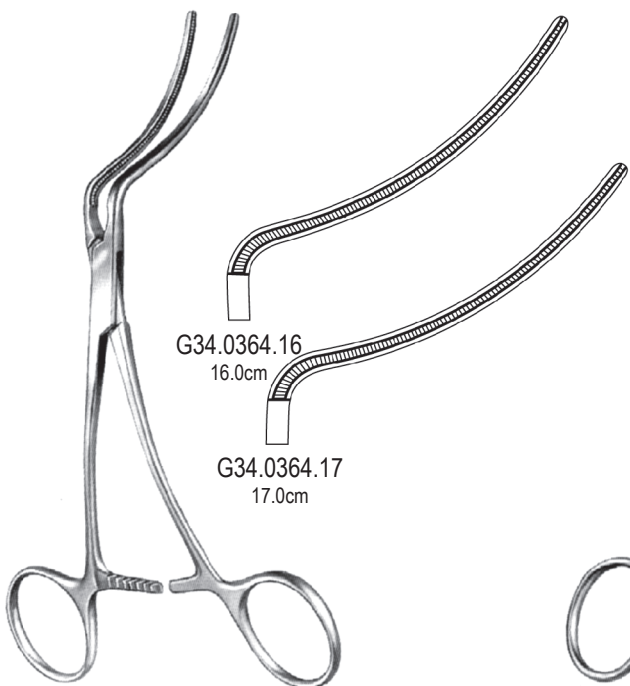

G34.0364.16
16.0cm

G34.0364.17
17.0cm

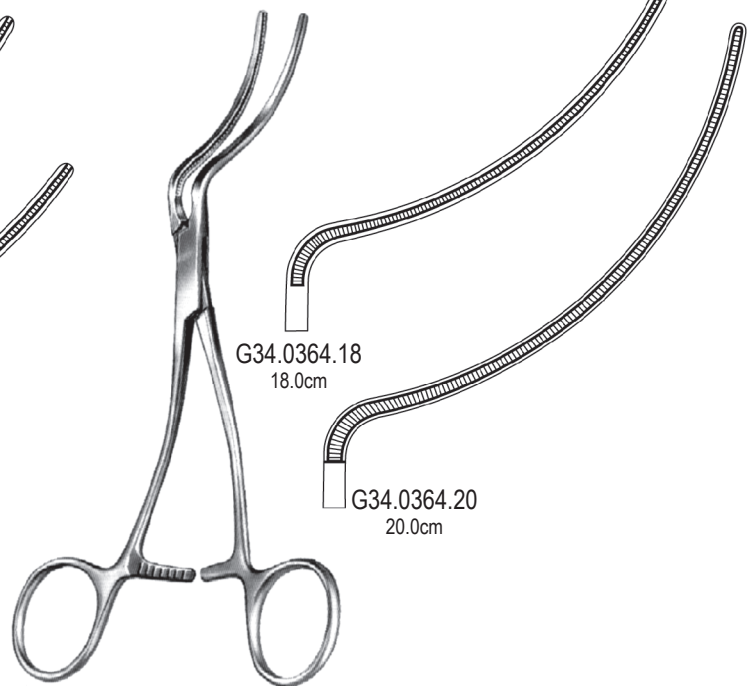

G34.0364.18
18.0cm

G34.0364.20
20.0cm



G34

Peripheral-Gefaßklemmen DE

Peripheral Vascular Clamps EN

Pinzas-clamps para vasos perifericos ES

المشابك الأوعية الدموية الطرفية AR

ALSO AVAILABLE IN TITANIUM



DE BAKEY

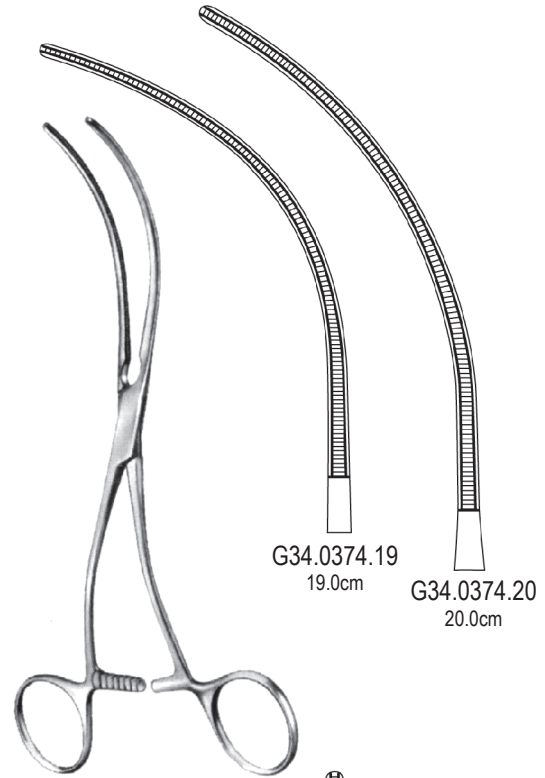

DE BAKEY



DE BAKEY

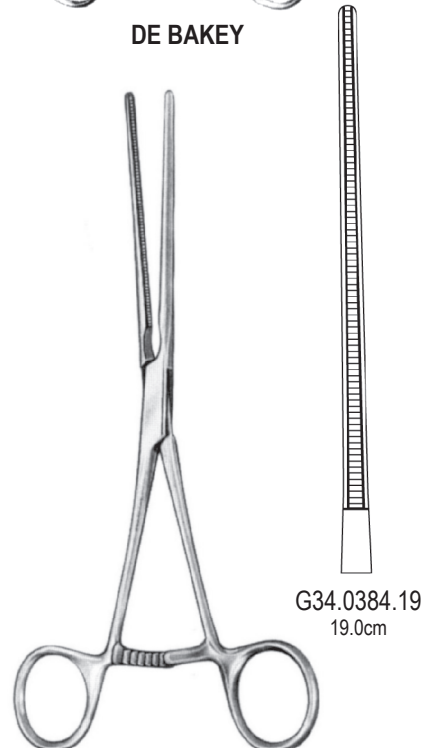

LELAND JONES

G34-026 G34.0384.19



- DE Peripheral-Gefaßklemmen
- EN Peripheral Vascular Clamps
- ES Pinzas-clamps para vasos perifericos
- AR المشابك الأوعية الدموية الطرفية

ALSO AVAILABLE IN TITANIUM



LELAND JONES

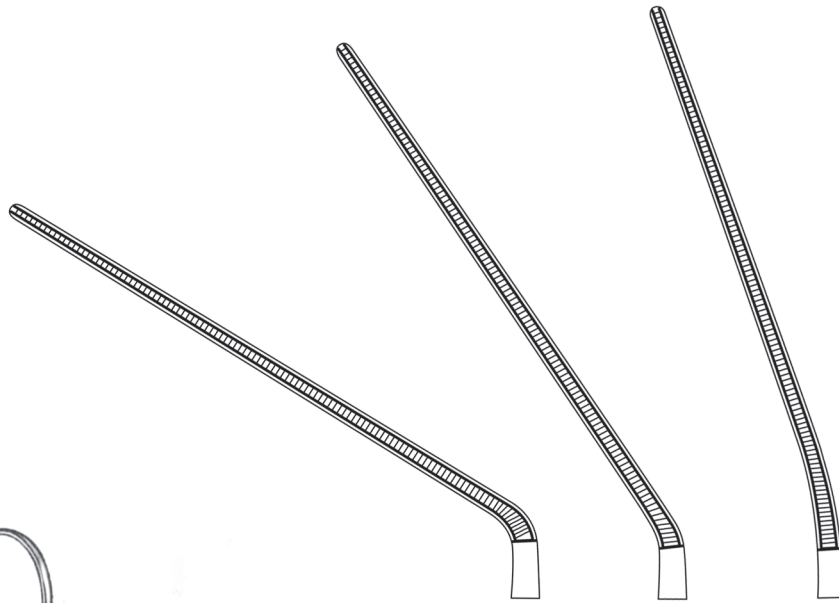

G34.0390.18 18.0cm
G34.0390.19 19.0cm
G34.0390.20 20.0cm



DALE

G34.0394.18
18.5cm



DALE



G34.0400.17 17.0cm
G34.0400.18 18.0cm
G34.0400.19 19.0cm

G34.0400.19 **G34-027**



G34

Ligaturklemmen DE

Ligature Clamps EN

Pinzas para ligadura ES

المشابك ضد AR

ALSO AVAILABLE IN TITANIUM



DE BAKEY

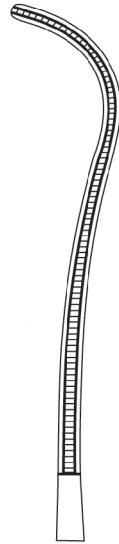

G34.0404.19
19.0cm

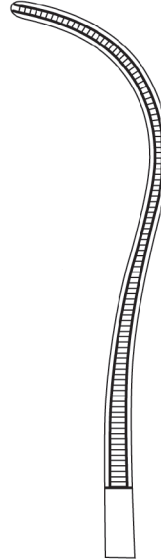

G34.0404.23
23.0cm



G34.0410.24
24.0cm

DE BAKEY

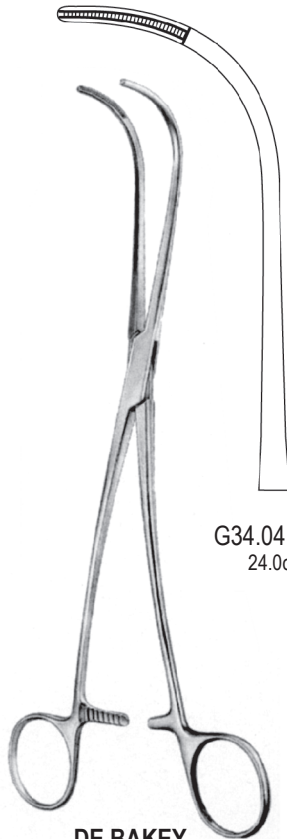

G34.0414.24
24.0cm

DE BAKEY

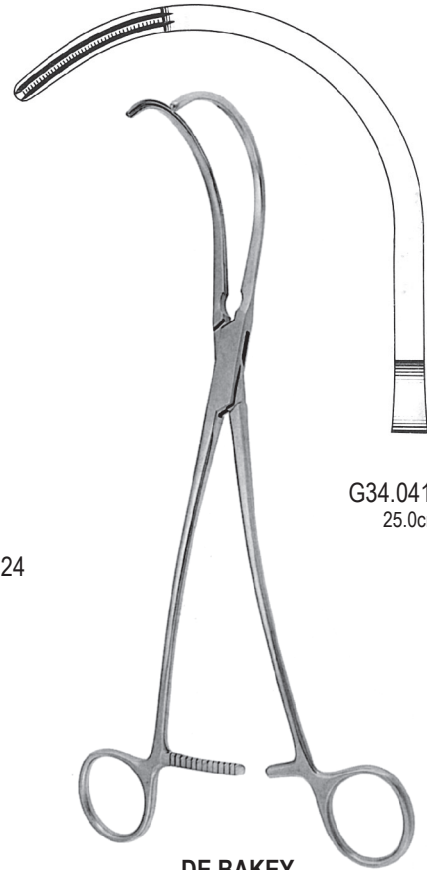

G34.0414.25
25.0cm

DE BAKEY

G34-028 G34.0414.25



- DE Aurikeklemmen, Bronchusklemmen
- EN Auricle Clamps, Bronchus Clamps
- ES Pinzas clamps para auricula, pinzas clamps bronquiales
- AR المشابك الأذن، المشابك قصبية

ALSO AVAILABLE IN TITANIUM



HARKEN
24.0cm

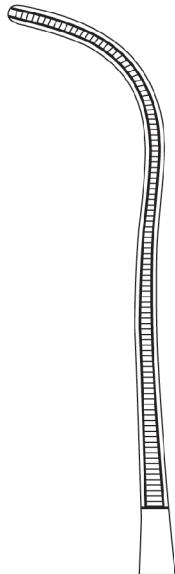

G34.0420.01

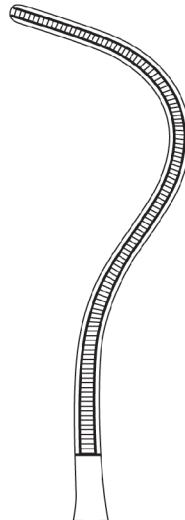

G34.0420.02

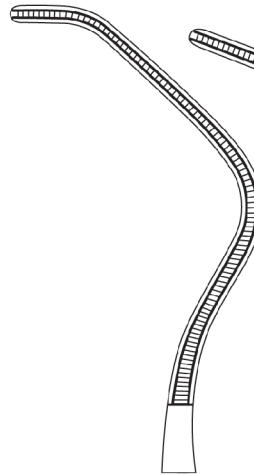

G34.0420.03

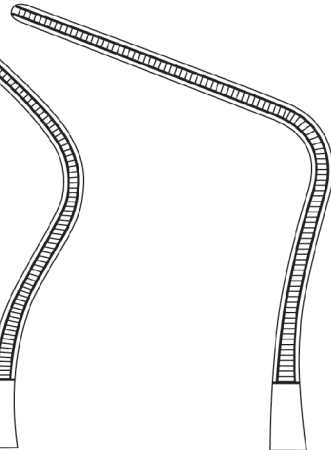

G34.0420.04



LEES

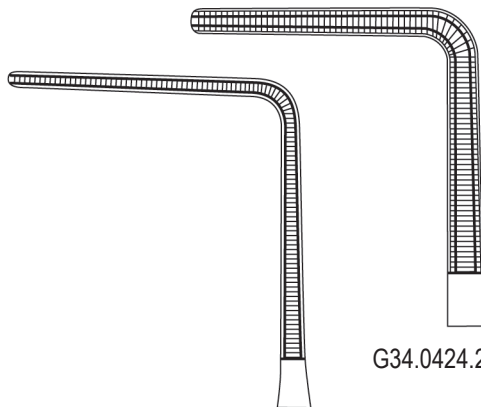

G34.0424.23 23.0cm

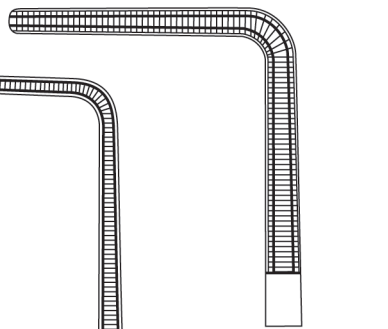

G34.0424.25 25.0cm



LEES

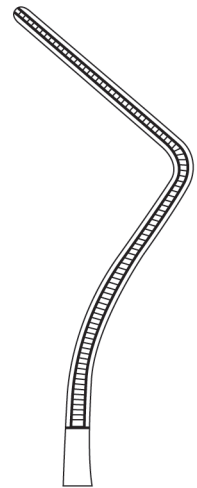

G34.0430.25 25.0cm

G34.0430.25 **G34-029**



G34

Coarctationsklemmen DE

Coarctation Clamps EN

Pinzas clamps para coarctacion ES

المشابك تضيق AR

ALSO AVAILABLE IN TITANIUM

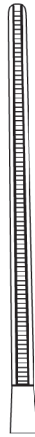

G34.0434.21
21.0cm



G34.0434.23
23.0cm



G34.0434.27
27.0cm



G34.0434.31
31.0cm



G34.0435.21
21.0cm

G34.0435.23
23.0cm

G34.0435.27
27.0cm

G34.0435.31
31.0cm

G34-030 G34.0435.31



- DE Mehrzweckklemmen
- EN Multi Purpose Clamps
- ES Pinzas-clamps para usos varios
- AR المشابك متعددة الأغراض

ALSO AVAILABLE IN TITANIUM



DE BAKEY

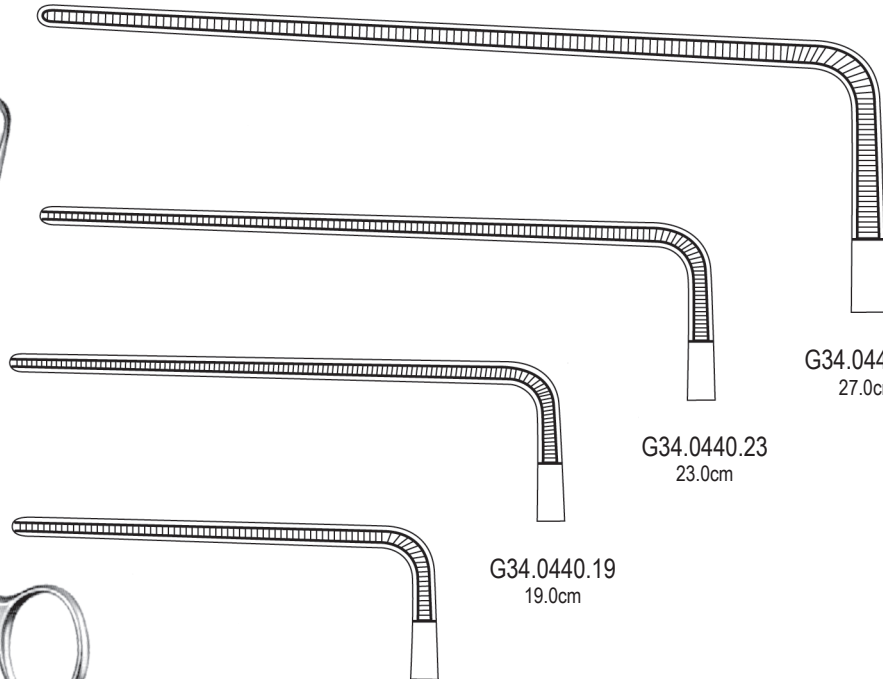

G34.0440.27
27.0cm

G34.0440.23
23.0cm

G34.0440.19
19.0cm

G34.0440.18
18.0cm



DE BAKEY



G34.0444.20
20.0cm

G34.0444.21
21.0cm

G34.0444.25
25.0cm

G34.0444.29
29.0cm

G34.0444.29 **G34-031**



G34

Atrauma Cardiovascular-Klemmen DE

Atrauma Cardiovascular Forceps EN

Atrauma pinzas-clamps cardiovasculares ES

الاستيطاني القلب والأوعية الدموية الماقت AR

ALSO AVAILABLE IN TITANIUM

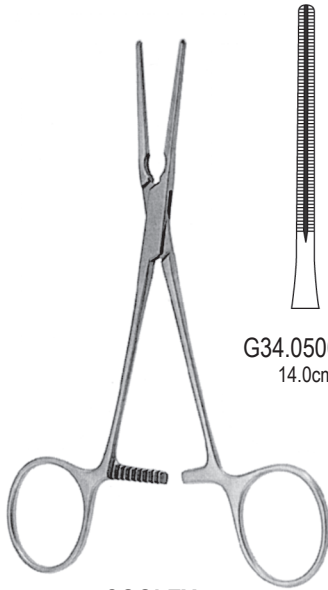

G34.0500.01
14.0cm

COOLEY

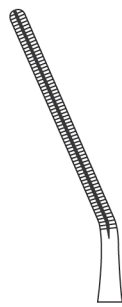

G34.0500.02
14.0cm

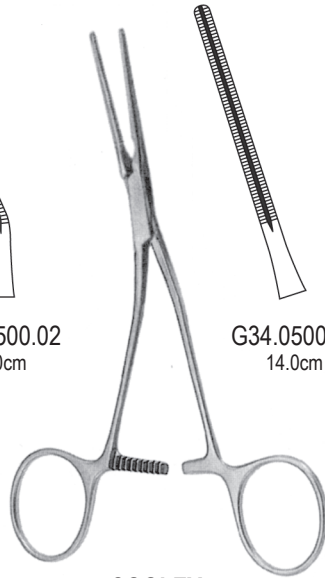

G34.0500.03
14.0cm

COOLEY

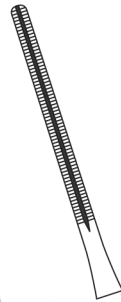

G34.0500.04
14.0cm

COOLEY

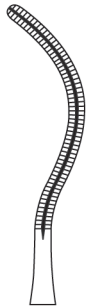
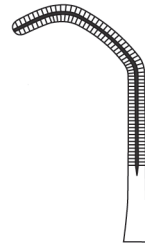

G34.0500.05
14.0cm



G34.0504.17
17.0cm

COOLEY

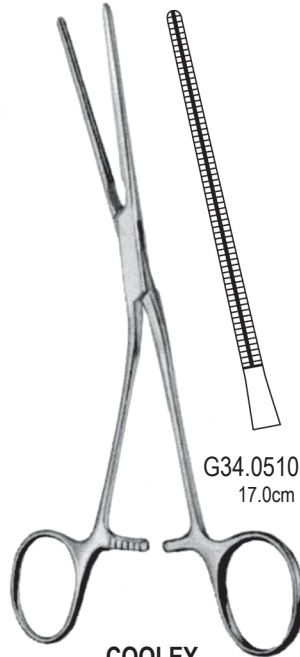

G34.0510.17
17.0cm

COOLEY

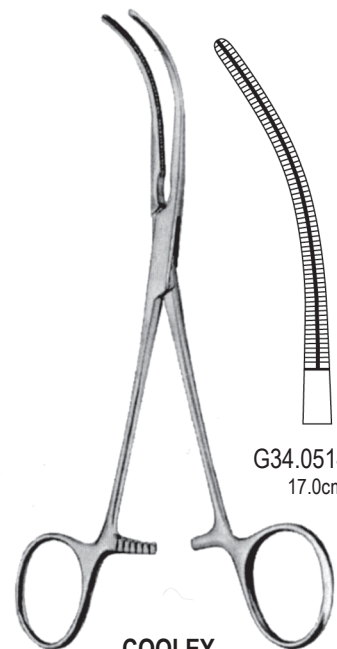
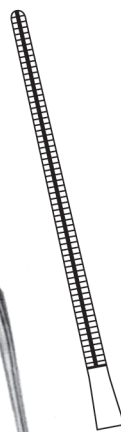

G34.0514.17
17.0cm

COOLEY

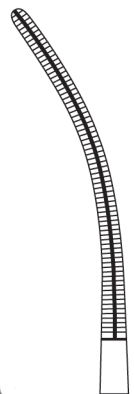

G34-032 G34.0514.17



DE **Atrauma Cardiovascular-Klemmen**
 EN **Atrauma Cardiovascular Forceps**
 ES **Atrauma pinzas-clamps cardiovasculares**
 AR **الاستيطاني القلب والأوعية الدموية الماقت**

ALSO AVAILABLE IN TITANIUM

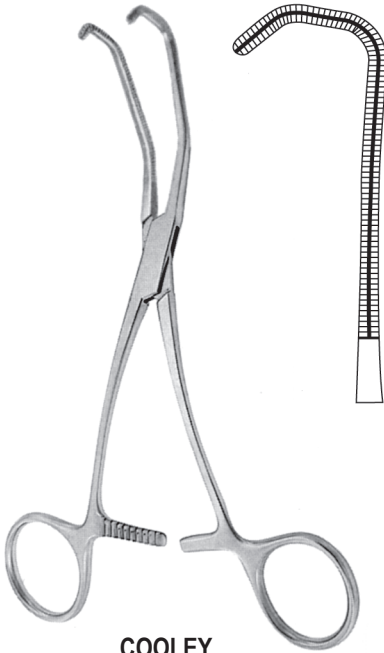

COOLEY
G34.0520.17 17.0cm

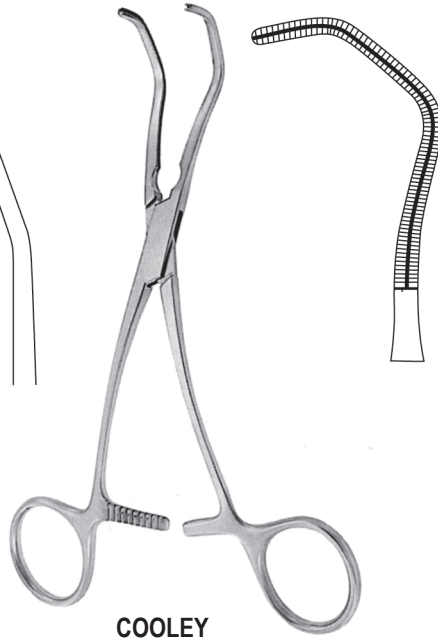

COOLEY
G34.0524.16 16.0cm



COOLEY
G34.0530.14 14.0cm

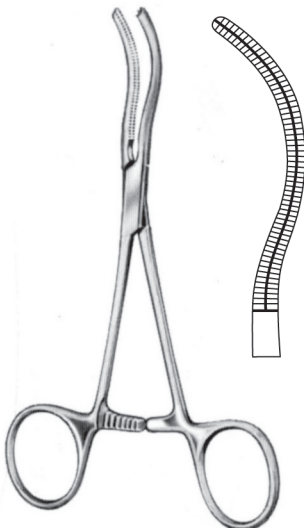

COOLEY
G34.0534.14 14.0cm

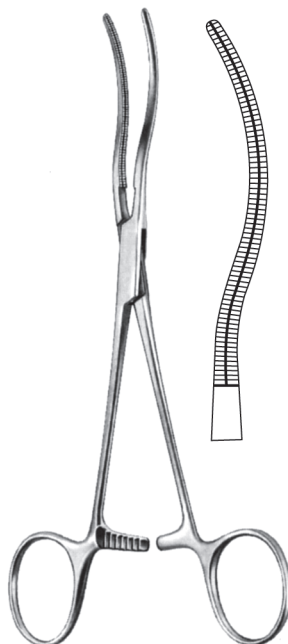

COOLEY
G34.0540.17 17.0cm

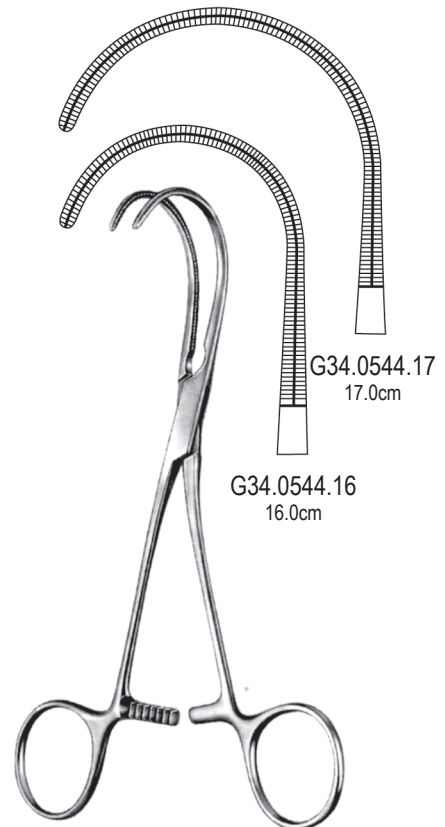

G34.0544.16
16.0cm

G34.0544.17
17.0cm

COOLEY

G34.0544.17 **G34-033**



G34

Atrauma Cardiovascular-Klemmen DE

Atrauma Cardiovascular Forceps EN

Atrauma pinzas-clamps cardiovasculares ES

الاستيطاني القلب والأوعية الدموية الماقت AR

ALSO AVAILABLE IN TITANIUM



COOLEY-DERRA

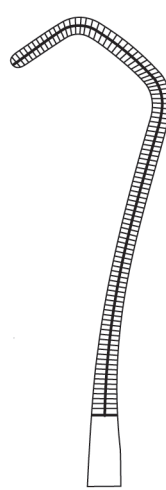

G34.0550.16
16.0cm

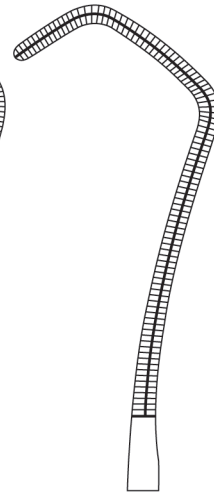

G34.0550.17
17.0cm

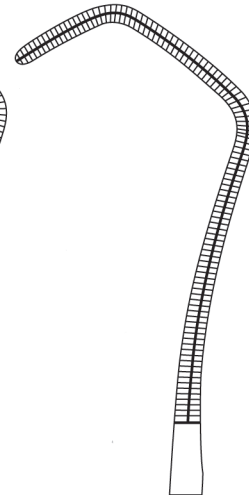

G34.0550.18
18.0cm



COOLEY

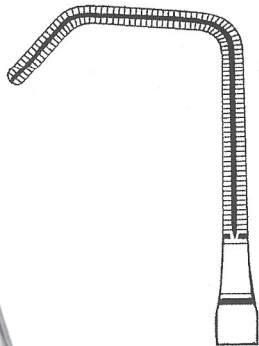

G34.0560.01
16.5cm

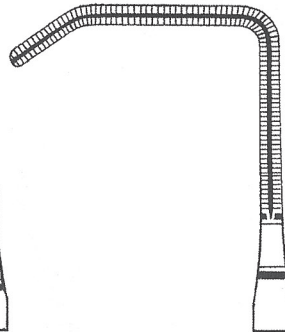

G34.0560.02
16.5cm

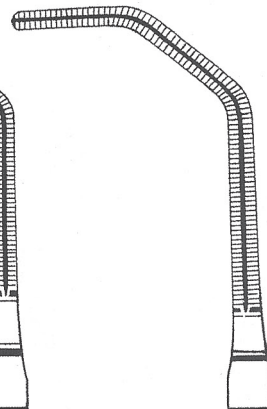

G34.0560.03
17.5cm

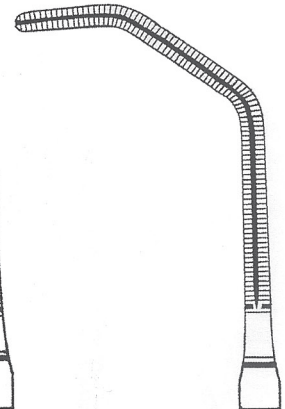

G34.0560.04
17.5cm

G34-034 G34.0560.03



- DE Atrauma Atrauma Klemmen
- EN Atrauma Forceps
- ES Atrauma pinzas-clamps
- AR الاستيطاني الماقت

ALSO AVAILABLE IN TITANIUM

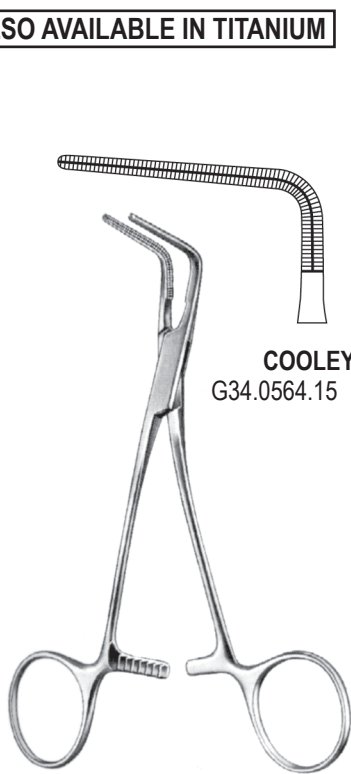

COOLEY
G34.0564.15 15.0cm



COOLEY
G34.0570.15 15.0cm

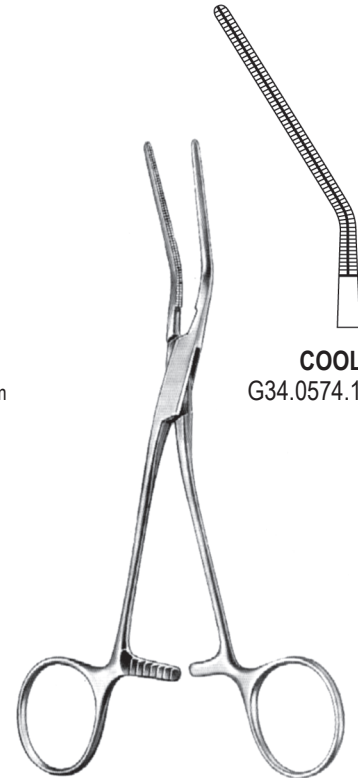

COOLEY
G34.0574.17 17.0cm

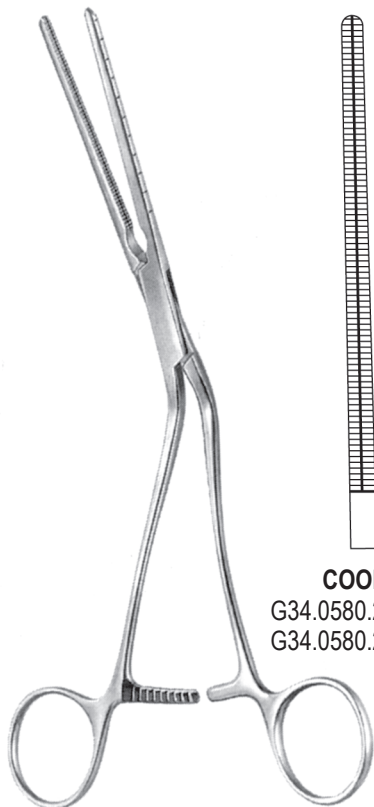

COOLEY
G34.0580.21 21.0cm
G34.0580.25 25.0cm



COOLEY
G34.0590.27 27.0cm

G34.0590.27 **G34-035**



G34

Atrauma Klemmen DE

Atrauma Forceps EN

Atrauma pinzas-clamps ES

الاستيطاني الملقط AR

ALSO AVAILABLE IN TITANIUM

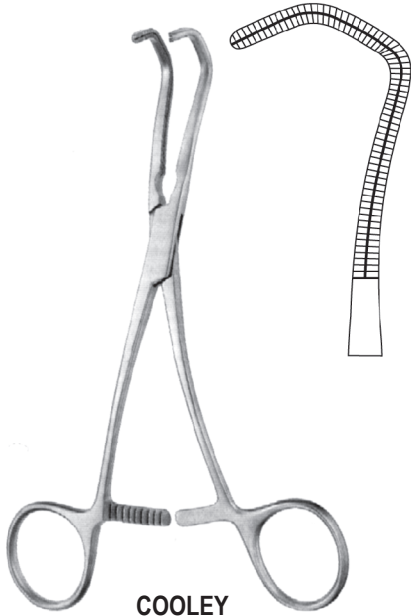

COOLEY
G34.0594.17 17.0cm

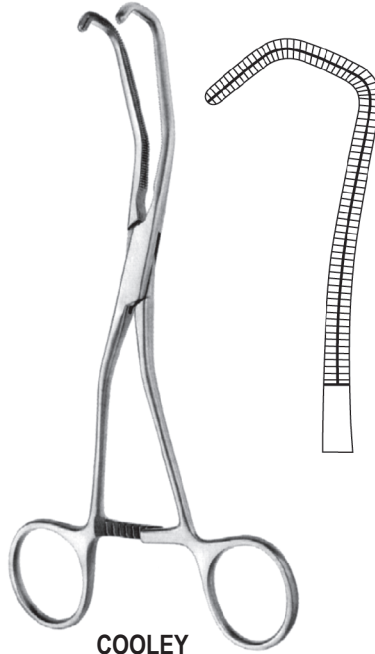

COOLEY
G34.0596.17 17.0cm

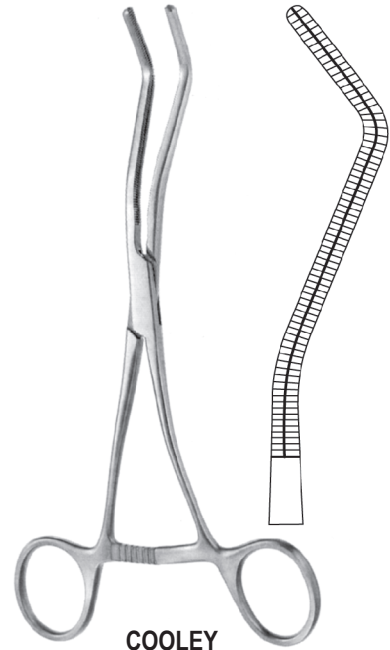

COOLEY
G34.0600.18 18.0cm

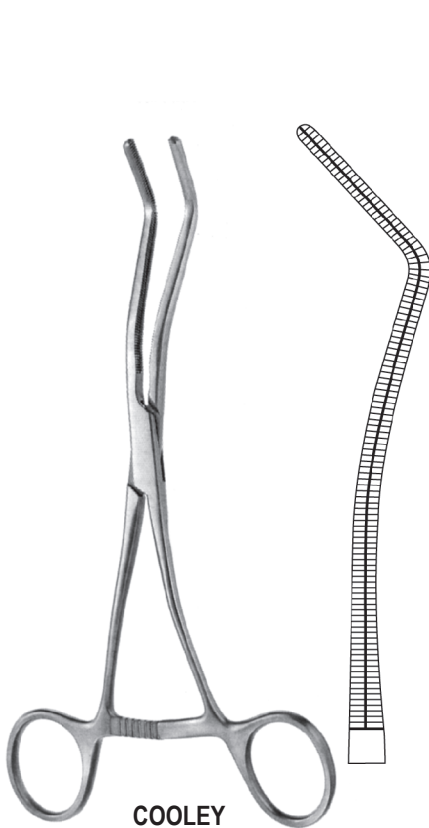

COOLEY
G34.0602.19 19.0cm



COOLEY
G34.0604.26 26.0cm

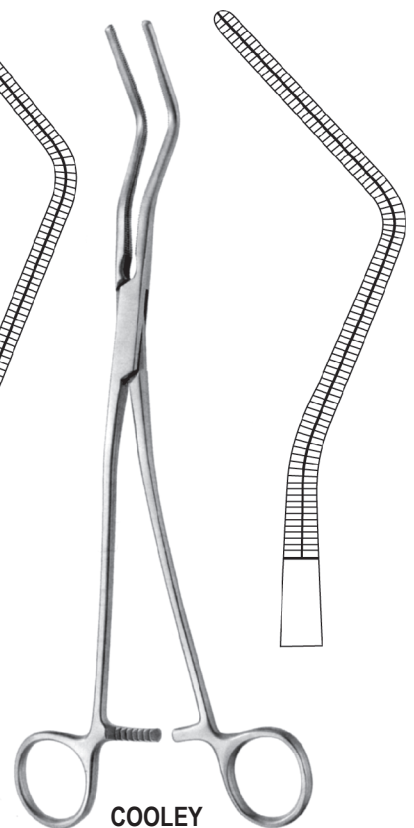

COOLEY
G34.0606.27 27.0cm

G34-036 G34.0606.27



DE Atrauma Neonatal-und Kinderklemmen

EN Atrauma and Pediatric Clamps

ES Atrauma pinzas clamps para recién nacidos y pediátricos

AR الاستيطاني والمشابك الأطفال

ALSO AVAILABLE IN TITANIUM



G34.0610.15 15.0cm

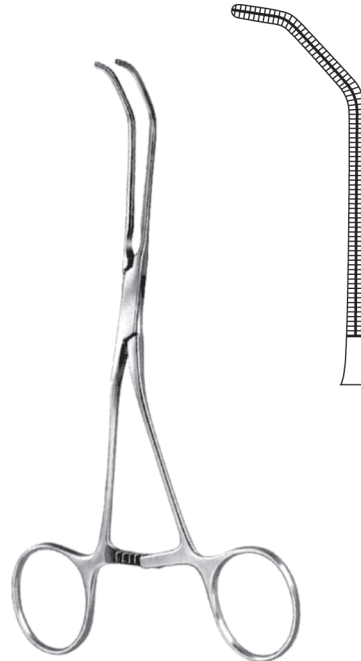

G34.0614.15 15.5cm

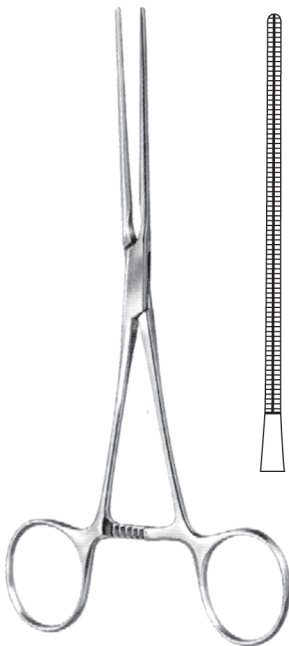

G34.0620.16 16.5cm

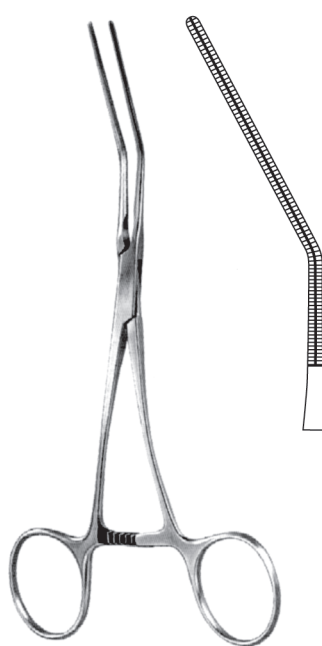

G34.0622.16 16.0cm

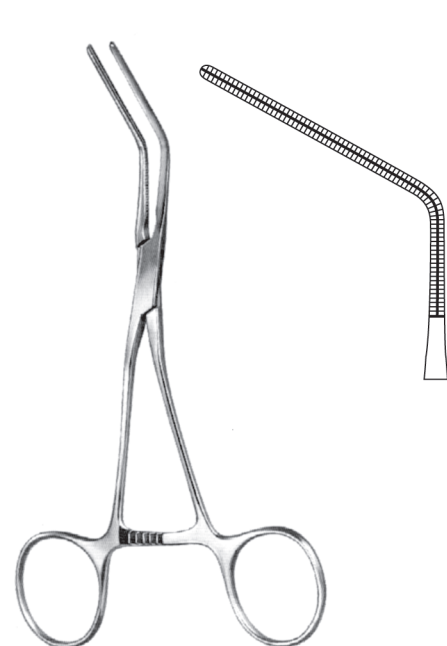

G34.0624.15 15.0cm

G34.0624.15 **G34-037**



G34

Neonatal-und Kinderklemmen, Extrafeine Modelle DE

Neonatal and Pediatric Clamps, Delicate Pattern EN

Pinzas clamps para recién nacidos y pediátricos muy delicados ES

المشابك والأطفال حديثي الولادة، نمط حساس AR

ALSO AVAILABLE IN TITANIUM

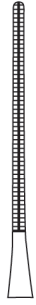

1

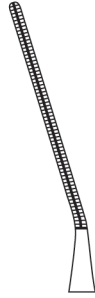

2

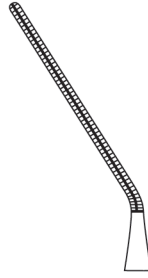

3

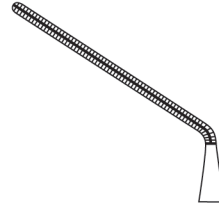

4

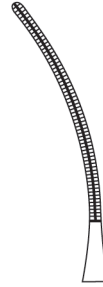

5

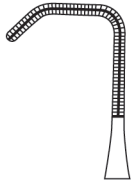

6

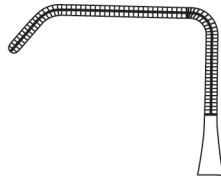

7

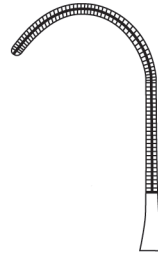

8



9



- 1 G34.0630.01 14.5cm
- 2 G34.0630.02 14.5cm
- 3 G34.0630.03 14.5cm
- 4 G34.0630.04 13.5cm
- 5 G34.0630.05 14.0cm
- 6 G34.0630.06 13.5cm
- 7 G34.0630.07 13.5cm
- 8 G34.0630.08 14.0cm
- 9 G34.0630.09 13.5cm



- 1 G34.0632.01 14.5cm
- 2 G34.0632.02 14.5cm
- 3 G34.0632.03 14.5cm
- 4 G34.0632.04 13.5cm
- 5 G34.0632.05 14.0cm
- 6 G34.0632.06 13.5cm
- 7 G34.0632.07 13.5cm
- 8 G34.0632.08 14.0cm
- 9 G34.0632.09 13.5cm



- 1 G34.0634.01 14.5cm
- 2 G34.0634.02 14.5cm
- 3 G34.0634.03 14.5cm
- 4 G34.0634.04 13.5cm
- 5 G34.0634.05 14.0cm
- 6 G34.0634.06 13.5cm
- 7 G34.0634.07 13.5cm
- 8 G34.0634.08 14.0cm
- 9 G34.0634.09 13.5cm

G34-038 G34.0634.09



- DE Neonatal-und Kinderklemmen, Extrafeine Modelle
- EN Neonatal and Pediatric Clamps, Delicate Pattern
- ES Pinzas clamps para recién nacidos y pediátricos muy delicados
- AR المشابك والأطفال حديثي الولادة، نمط حساس

ALSO AVAILABLE IN TITANIUM

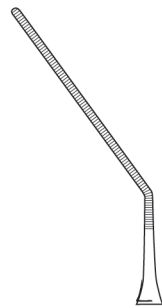

G34.0640.01
13.0cm

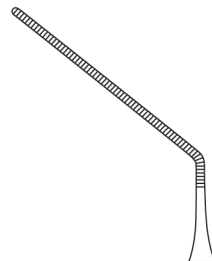

G34.0640.02
13.0cm

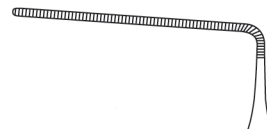

G34.0640.03
11.0cm



CASTANEDA

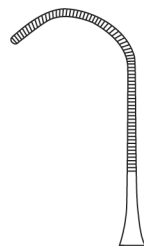

G34.0642.01
12.0cm

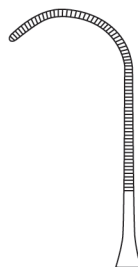

G34.0642.02
12.0cm

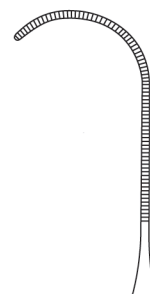

G34.0642.03
12.0cm

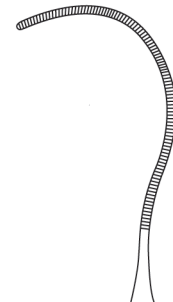

G34.0642.04
12.0cm



G34

Atrauma Cardiovascular-Klemmen DE

Atrauma Cardiovascular Forceps EN

Atrauma pinzas-clamps cardiovasculares ES

الاستيطاني القلب والأوعية الدموية الماقت AR

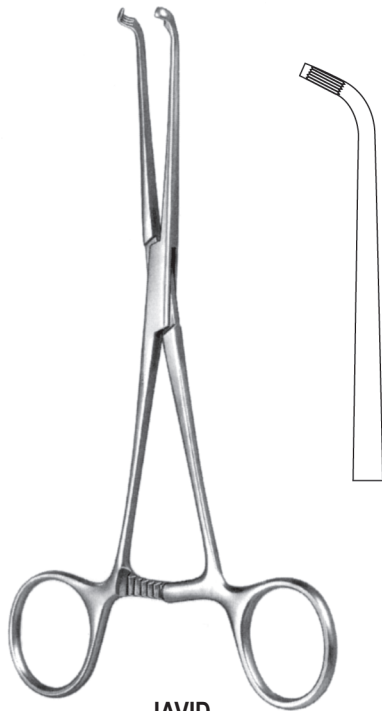

JAVID
G34.0650.18 18.0cm

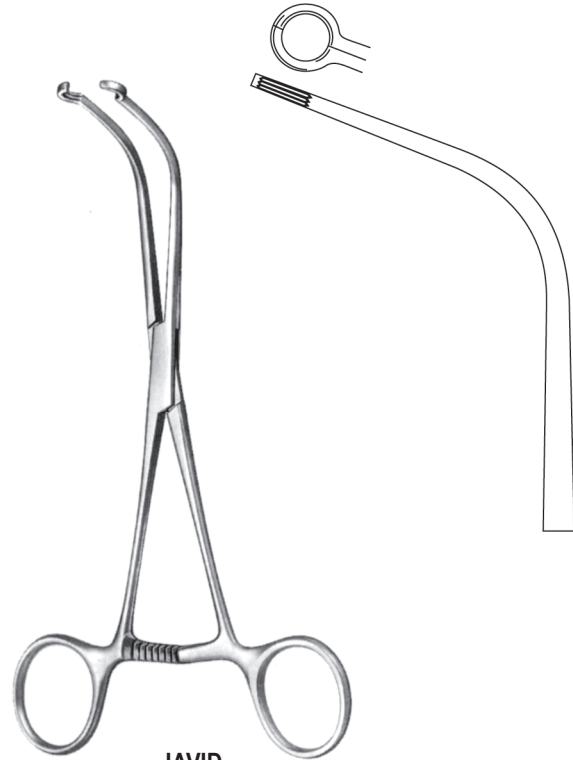

JAVID
G34.0650.19 19.0cm

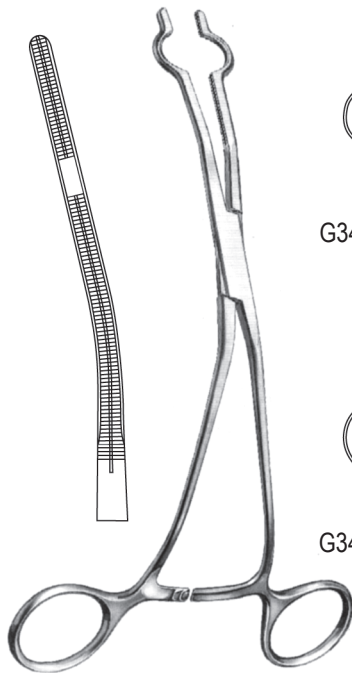

COOLEY

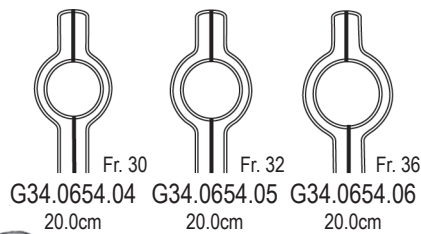
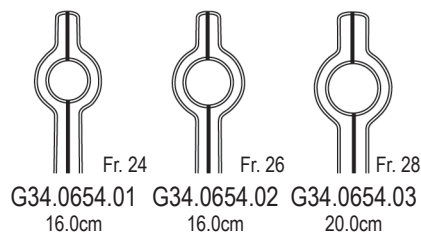

G34.0660.18 18.0cm

G34-040 G34.0660.18



- DE Mehrzweckklemmen
- EN Universal Clamps
- ES Pinze universali
- AR المشابك العالمي

ALSO AVAILABLE IN TITANIUM

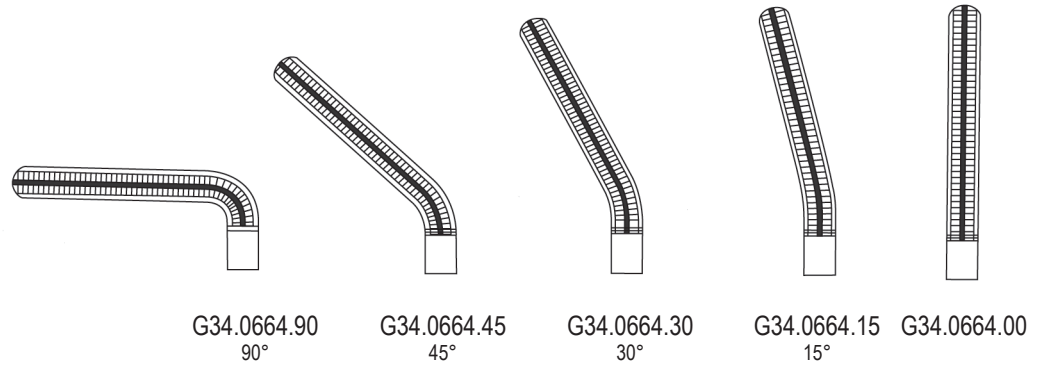

DARDIK

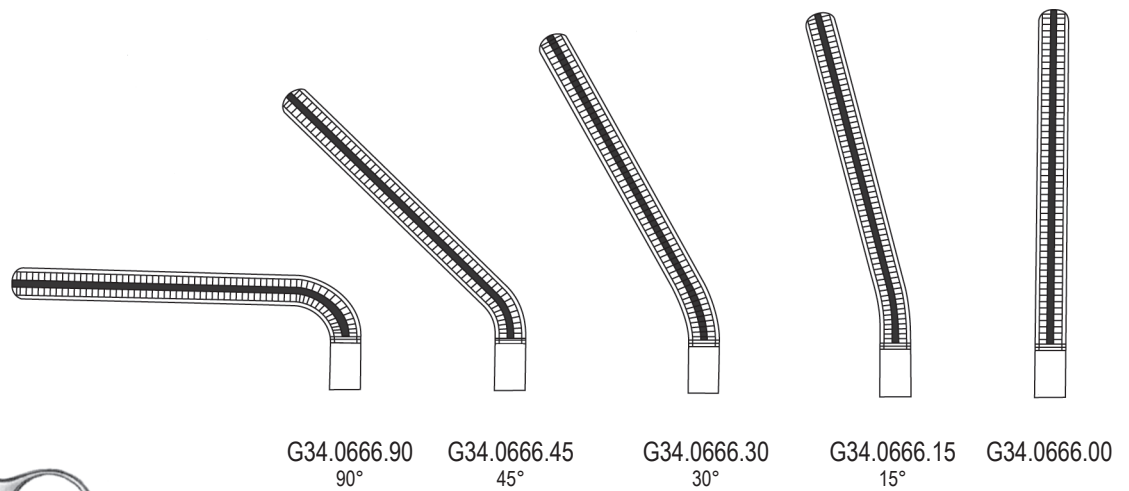

G34

Gefäßklemmen DE

Blood Vessel Clamps EN

Clamps p/vasos ES

المشابك الأوعية الدموية AR

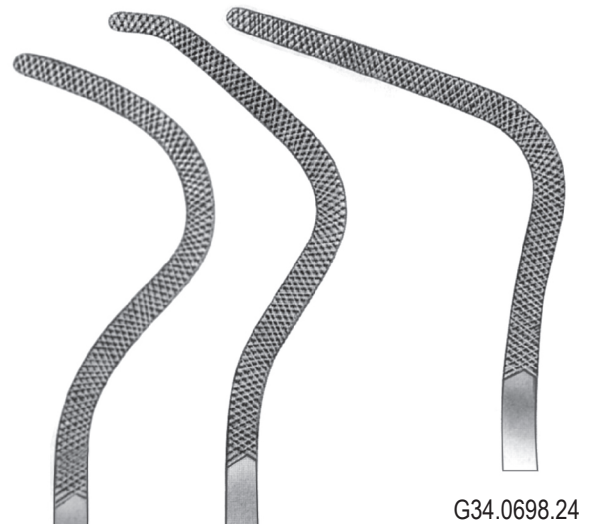
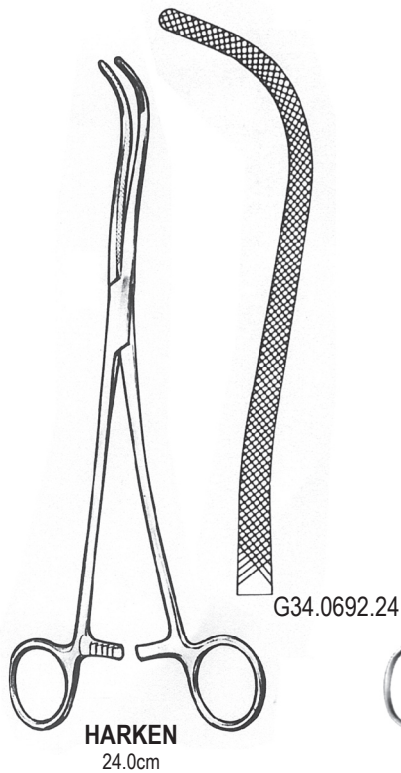
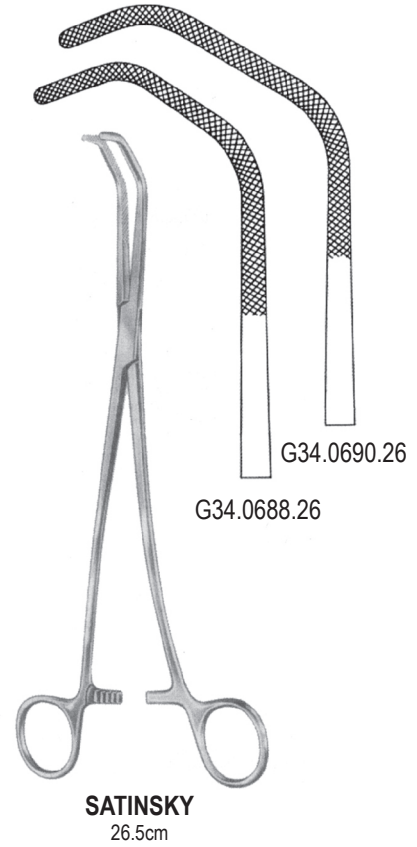
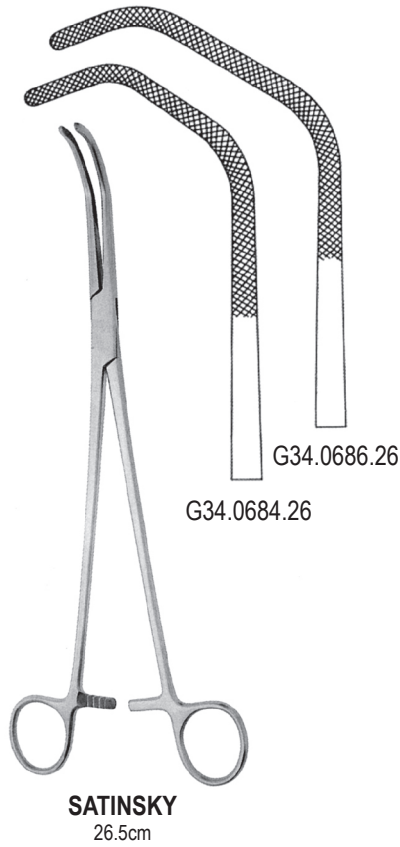
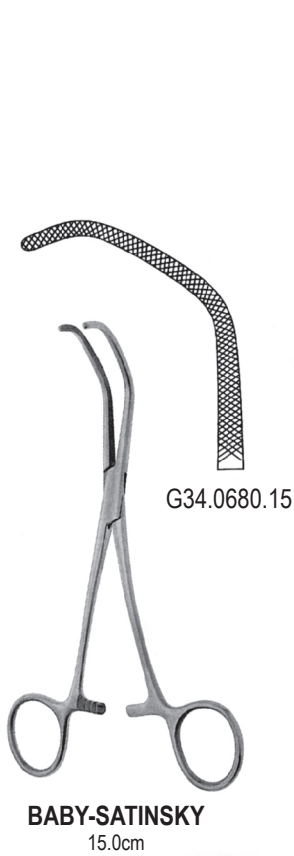

G34-042 G34.0698.24



DE Lungenfazzangen, Aortaklemmen
 EN Lung Grasping Forceps, Aorta Clamps
 ES Pinzas-Clamps p/pulmón, Clamps aorta
 AR الرئة الملقط استيعاب والمشابك الأهر



LOVELACE
G34.0710.20 20.0cm

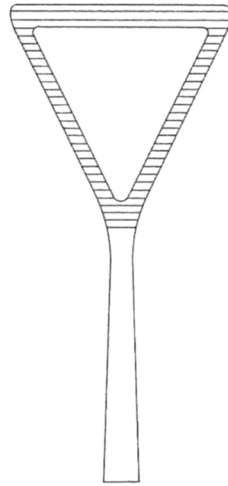

LOVELACE
G34.0711.20 20.0cm



BLALOCK



G34.0720.14 15.0cm

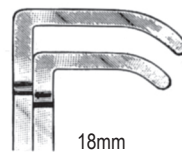

G34.0722.18 20.0cm

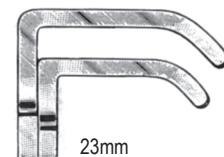

G34.0722.23 20.0cm



G34

Gefäß-Dilatoren DE

Vascular Dilators EN

Dilatadores vasculares ES

الموسعات الوعائية AR

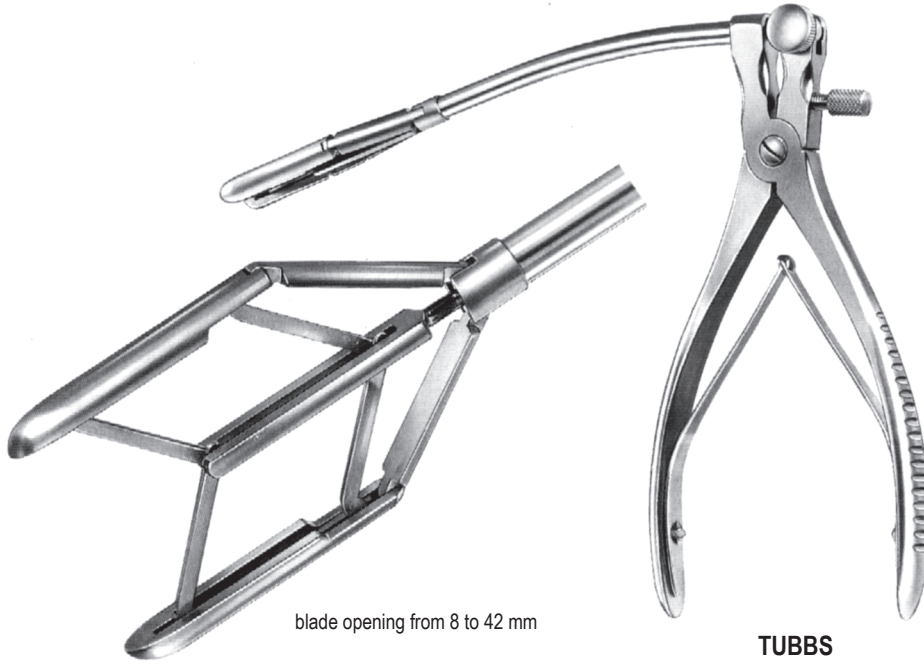

TUBBS
G34.0740.42

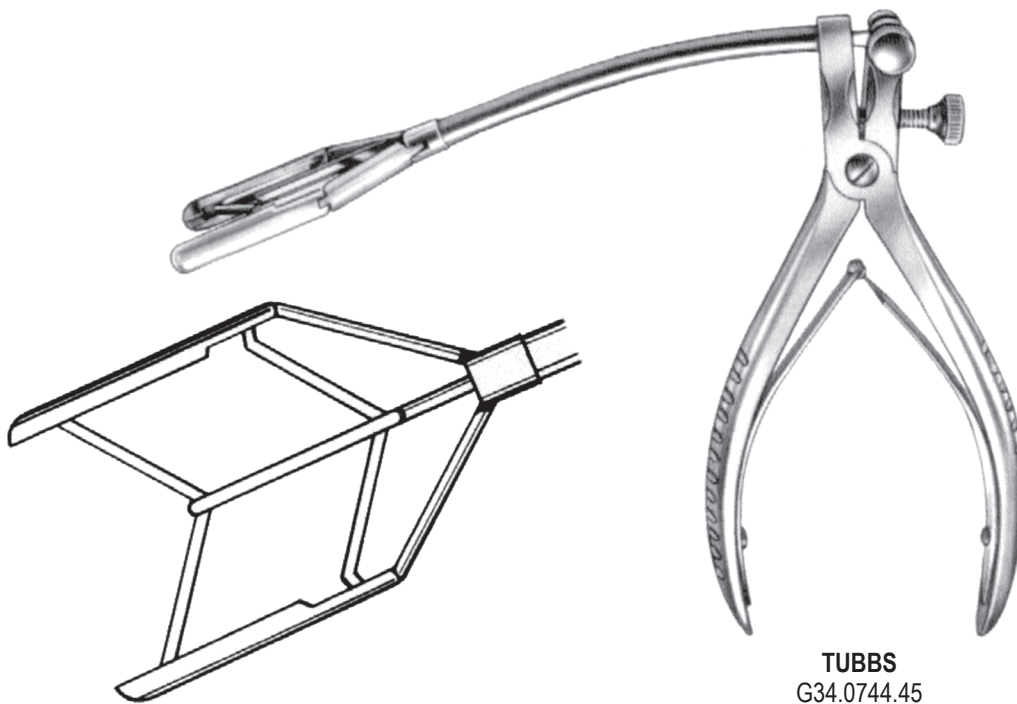

TUBBS
G34.0744.45

G34-044 G34.0744.45



DE Gefäß-Dilatoren
EN Vascular Dilators
ES Dilatadores vasculares
AR الموسعات الوعائية

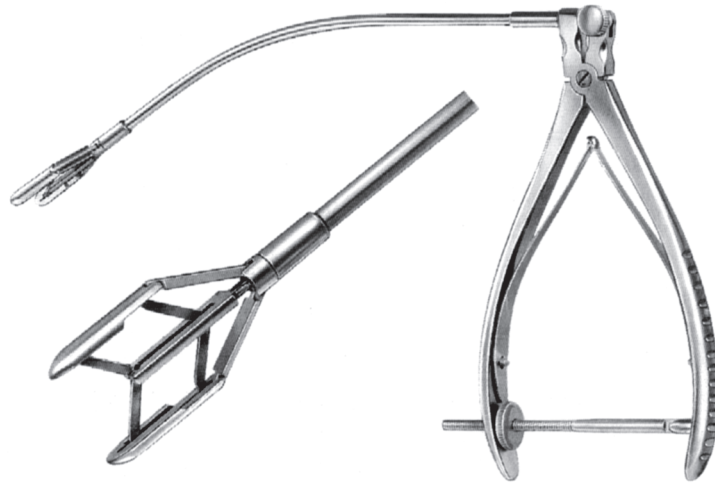

blade opening from 8 to 15 mm
blade opening from 8 to 45 mm

COOLEY
G34.0750.15
G34.0750.45

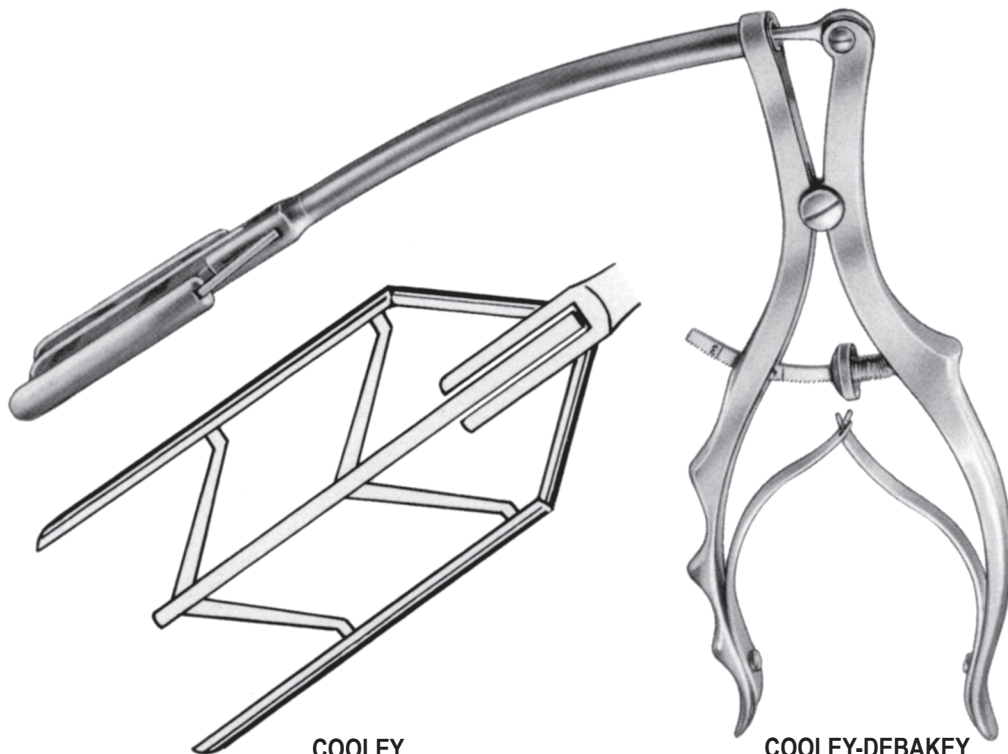

COOLEY
G34.0754.40
blade opening 9 - 40mm

COOLEY-DEBAKEY
G34.0756.30
blade opening 7 - 30mm

G34.756.30 **G34-045**



G34

Gefäß-Dilatatoren DE

Vascular Dilators EN

Dilatadores vasculares ES

الموسعات الوعائية AR

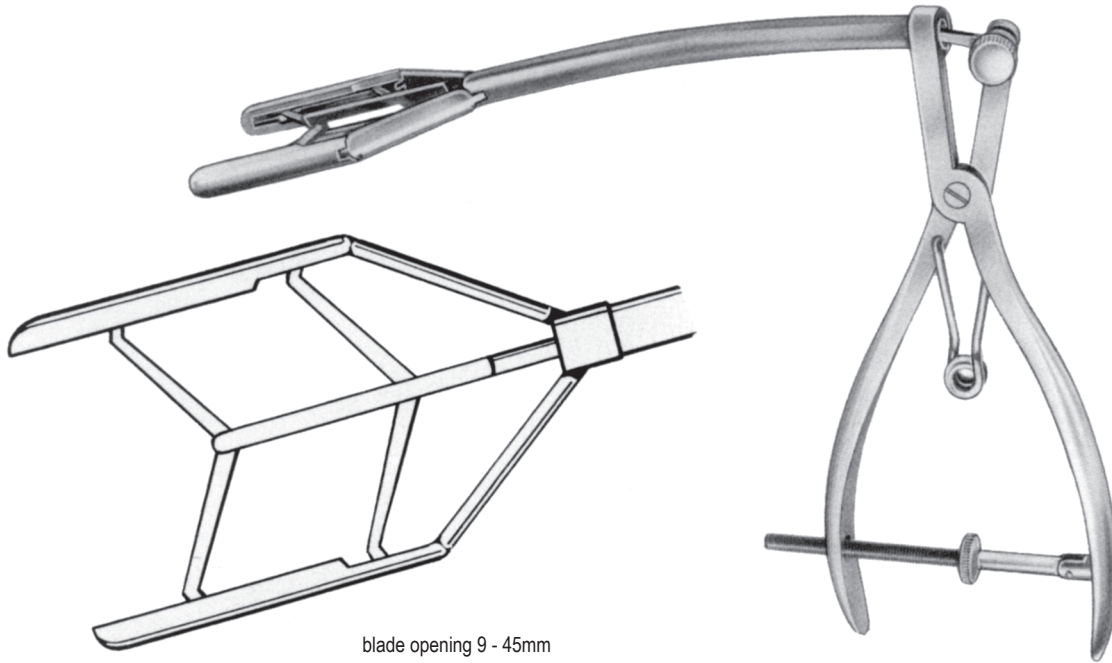

blade opening 9 - 45mm

GERBODE
G34.0760.45

G34-046 G34.0760.45



DE Mitral ventil dilatoren

EN Mitral valve Dilators

ES Dilatadores mitral de válvula

AR الموسعات الصمام التاجي



Blade opening 4 - 10mm

HETZER
G34.0770.10

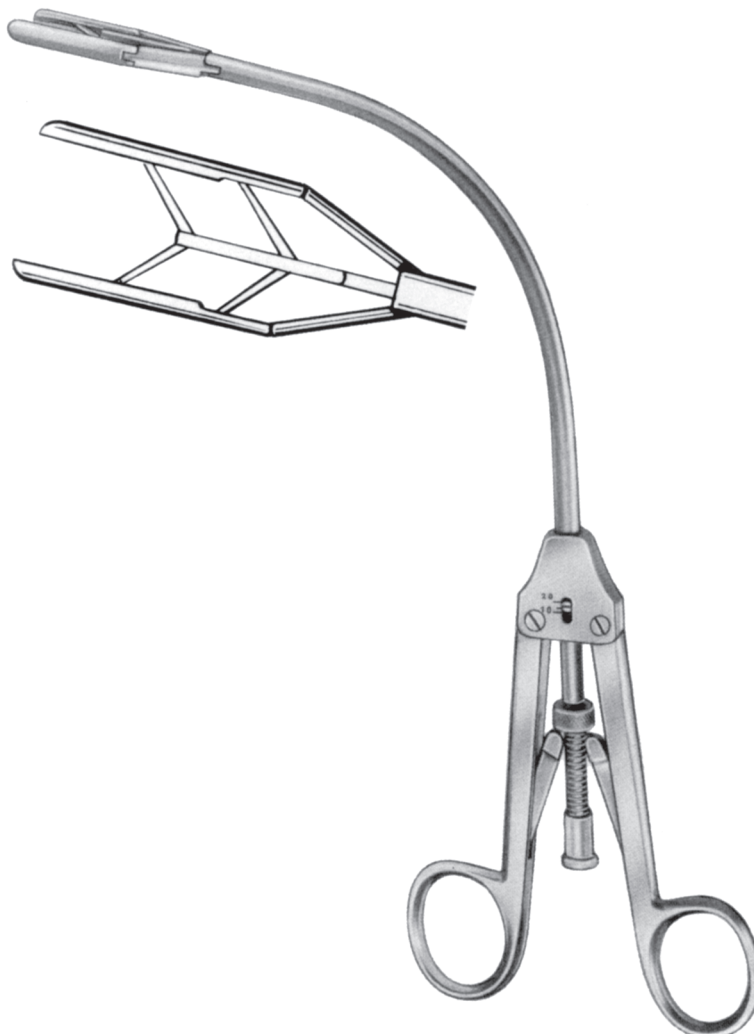

COOLEY blade opening
G34.0776.18 5 - 18mm
G34.0776.20 6 - 20mm

G34.776.20 **G34-047**



G34

Nervhakchen, Tourniquets, Tunnelier-Instrumente **DE**

Nerve Hooks, Tourniquets, Tunneling Instruments **EN**

Separadores de nervios, torsniquetes, instrumento para tunelar **ES**

خطاف العصب، بوابات، أدوات الاتصال النفقي **AR**



CRILE 20.0cm
G34.0780.01
G34.0780.02

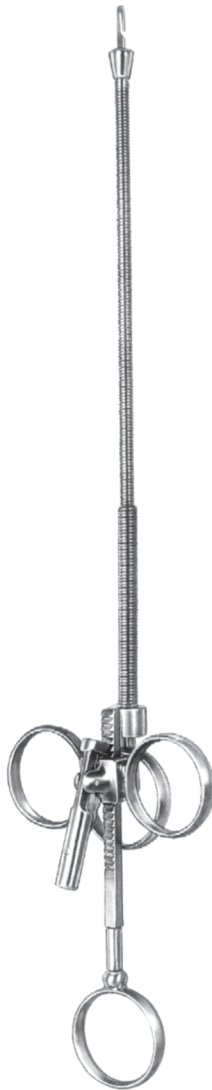

RUMEL-BELMONT 33.0cm
G34.0784.32 3.2mm Ø
G34.0784.64 6.4mm Ø



26.0cm

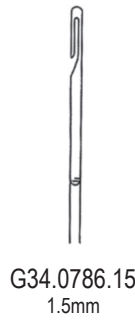

G34.0786.15
1.5mm

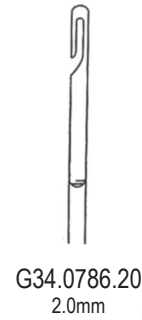

G34.0786.20
2.0mm

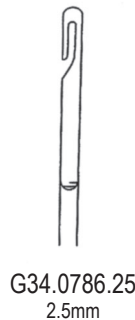

G34.0786.25
2.5mm

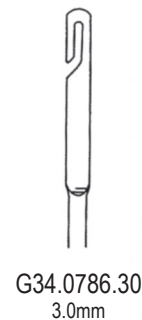

G34.0786.30
3.0mm



DE BAKEY
G34.0790.50 50.0cm

G34-048 G34.0790.50

DE Endarteriektomie Spachtel und Dilatoren
 EN Endarterectomy Spatula and Dilators
 ES Espátula y dilatadores endarterectomia
 AR ملعقة استئصال باطنة الشريان والموسعات

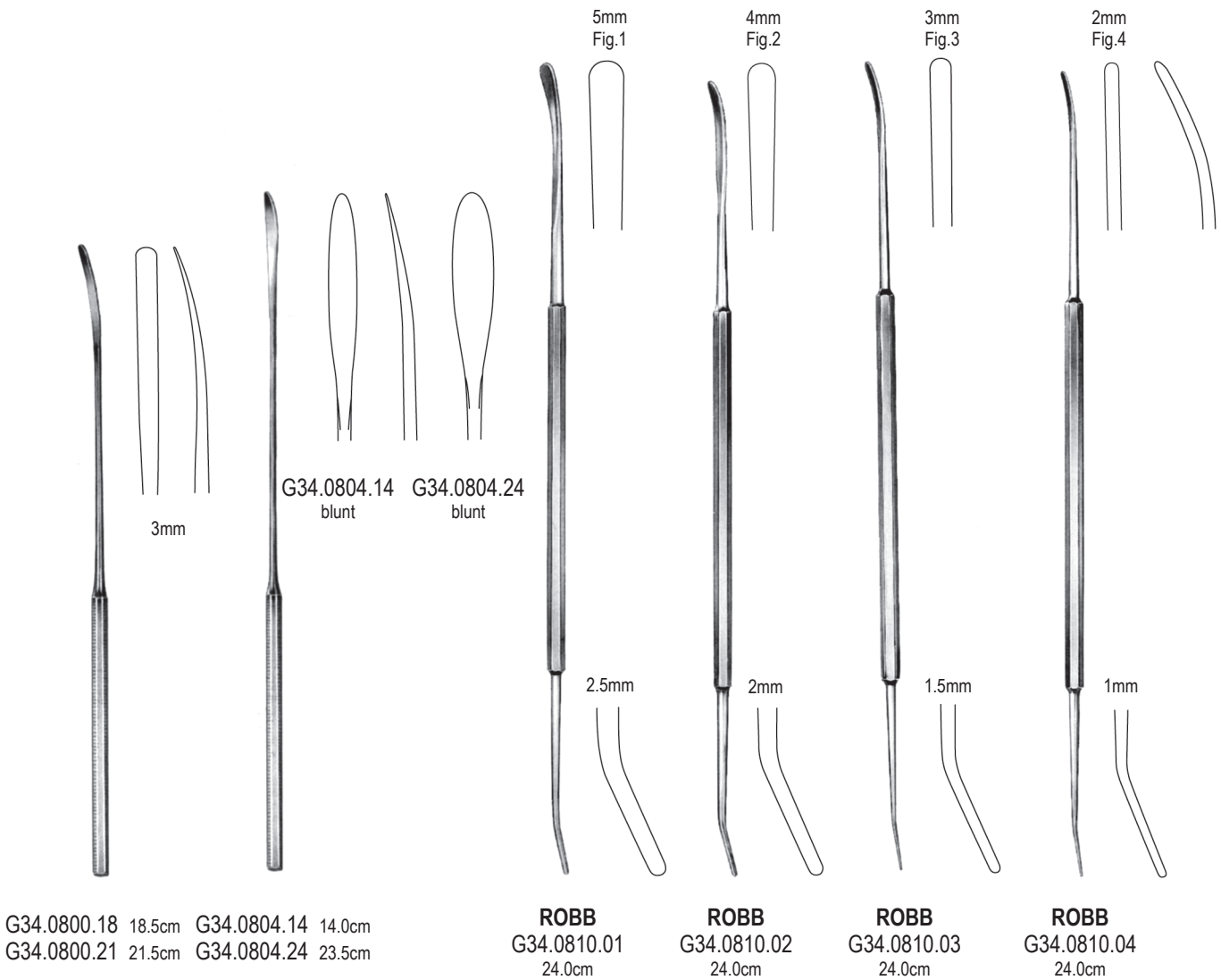

G34

Gefäß-Dilatatoren DE

Vascular Dilators EN

Dilatadores vasculares ES

الموسعات الوعائية AR



G34.0820.05
0.5mm Ø

G34.0820.10
1.0mm Ø

G34.0820.15
1.5mm Ø

G34.0820.20
2.0mm Ø

G34.0820.25
2.5mm Ø

G34.0820.30
3.0mm Ø

G34.0820.40
4.0mm Ø

G34.0820.50
5.0mm Ø

COOLEY
13.0cm



19.0cm G34.0824.05
35.0cm G34.0828.05
0.5mm Ø

G34.0824.10
G34.0828.10
1mm Ø

G34.0824.15
G34.0828.15
1.5mm Ø

G34.0824.20
G34.0828.20
2mm Ø

G34.0824.25
G34.0828.25
2.5mm Ø

G34.0824.30
G34.0828.30
3mm Ø

19.0cm G34.0824.35
35.0cm G34.0828.35
3.5mm Ø

G34.0824.40
G34.0828.40
4mm Ø

G34.0824.45
G34.0828.45
4.5mm Ø

G34.0824.50
G34.0828.50
5mm Ø

G34.0824.70
G34.0828.70
7mm Ø

G34.0824.90
G34.0828.90
9mm Ø

DE BAKEY

G34-050 G34.0828.90

