

- **Medical Equipment**
- **Surgical instruments**

Kochenchirurgie

DE	Kochenchirurgie
EN	Bone Surgery
ES	Cirugia ósea
AR	جراحة العظام

G28

PAGE 001 to 076

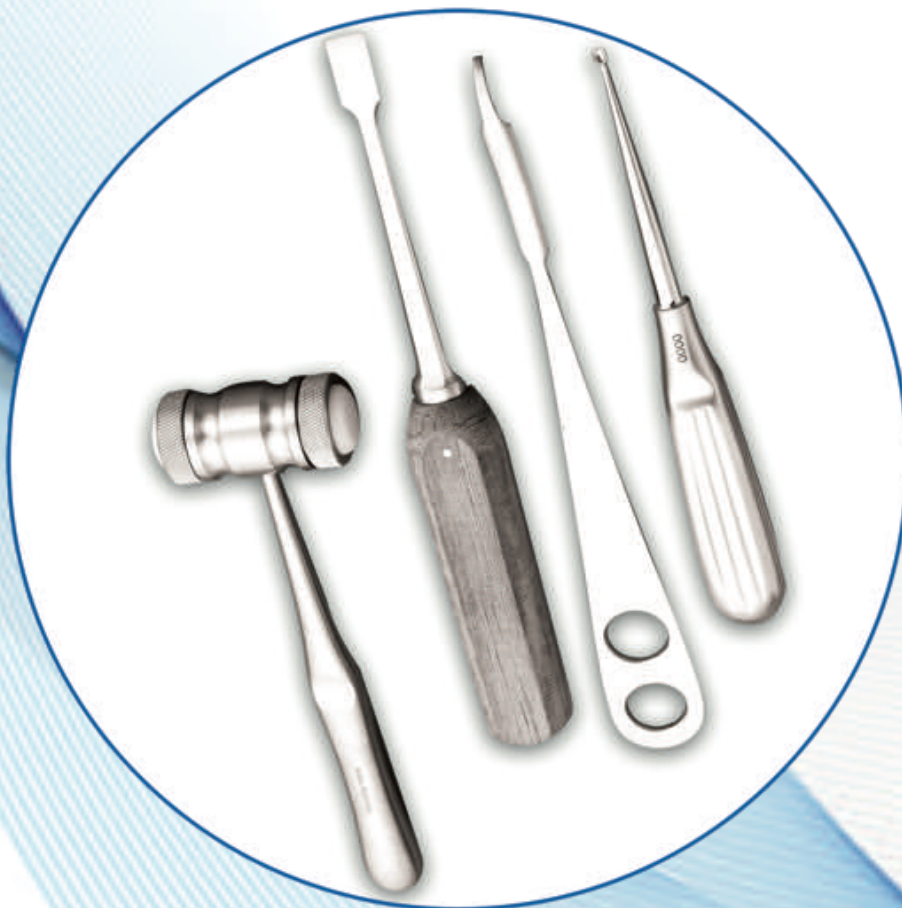

DE Meissel und Osteotome
 EN Bone Chisels and Gouges
 ES Cinceles y gubias para huesos
 AR الأزاميل والعظام والحفارات



G28.0010.08 8mm
 G28.0010.10 10mm
 G28.0010.12 12mm
 G28.0010.14 14mm
 G28.0010.16 16mm
 13.5cm



G28.0012.08 8mm
 G28.0012.10 10mm
 G28.0012.12 12mm
 G28.0012.14 14mm
 G28.0012.16 16mm
 13.5cm



G28.0014.08 8mm
 G28.0014.10 10mm
 G28.0014.12 12mm
 G28.0014.14 14mm
 G28.0014.16 16mm
 13.5cm



PARTSCH
 13.5cm 17.0cm
 G28.0020.02 2mm G28.0022.02
 G28.0020.03 3mm G28.0022.03
 G28.0020.04 4mm G28.0022.04
 G28.0020.05 5mm G28.0022.05
 G28.0020.06 6mm G28.0022.06



PARTSCH
 13.5cm 17.0cm
 G28.0024.02 2mm G28.0026.02
 G28.0024.03 3mm G28.0026.03
 G28.0024.04 4mm G28.0026.04
 G28.0024.05 5mm G28.0026.05
 G28.0024.06 6mm G28.0026.06



G28

Meissel und Osteotome DE

Bone Chisels and Gouges EN

Cinceles y gubias para huesos ES

الأزميل العظام والحفارات AR



G28.0030.01



G28.0030.02



G28.0032.01



G28.0032.02



BUCK-GRAMCKO
11.0cm

BUCK-GRAMCKO
10.0cm



G28.0040.02
2mm



G28.0040.03
3mm



G28.0040.04
4mm



G28.0042.02
2mm



G28.0042.03
3mm



G28.0042.04
4mm



BUCKLEY
16.0cm

BUCKLEY
16.0cm

G28-002 G28.0042.04



DE Meissel und Osteotome
 EN Bone Chisels and Gouges
 ES Cinceles y gubias para huesos
 AR الأزاميل والعظام والحفارات

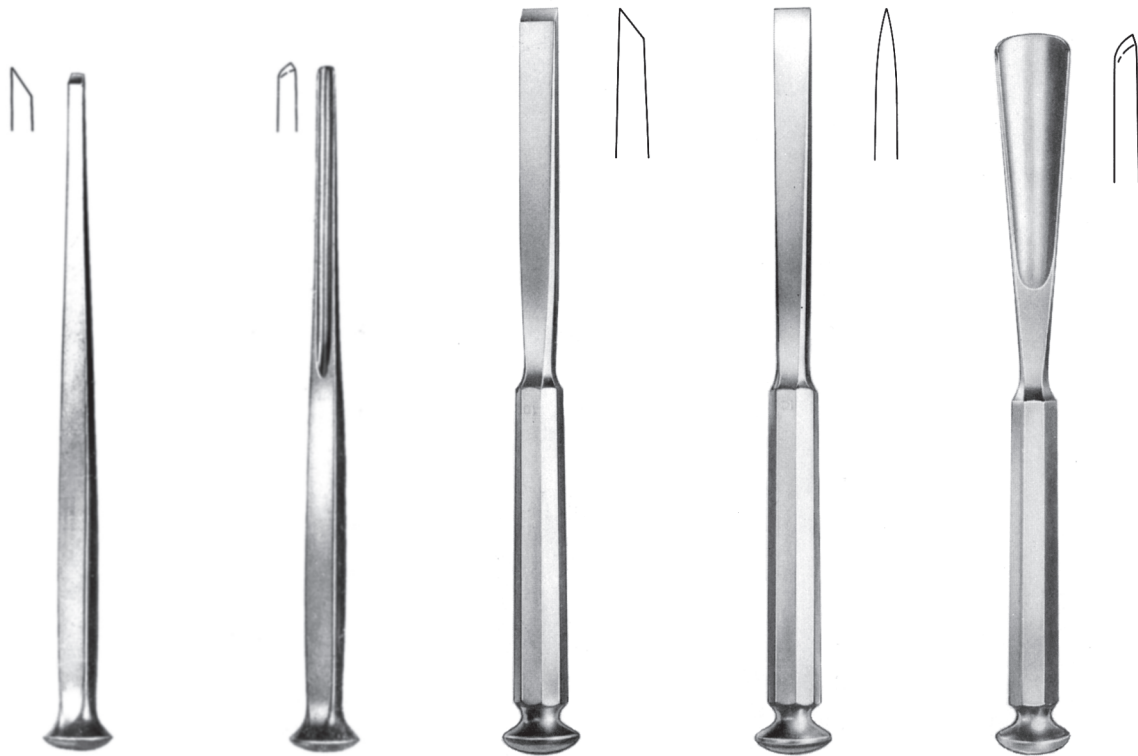

ALEXANDER 18.0cm		ALEXANDER 18.0cm		STILLE 20.0cm		STILLE 20.0cm		STILLE 20.0cm	
G28.0046.04	04mm	G28.0048.04	04mm	G28.0050.10	10mm	G28.0052.10	10mm	G28.0054.10	10mm
G28.0046.06	06mm	G28.0048.06	06mm	G28.0050.15	15mm	G28.0052.15	15mm	G28.0054.15	15mm
G28.0046.08	08mm	G28.0048.08	08mm	G28.0050.20	20mm	G28.0052.20	20mm	G28.0054.20	20mm
G28.0046.10	10mm	G28.0048.10	10mm	G28.0050.25	25mm	G28.0052.25	25mm	G28.0054.25	25mm
G28.0046.12	12mm	G28.0048.12	12mm						
G28.0046.14	14mm	G28.0048.14	14mm						

G28.0054.25 **G28-003**

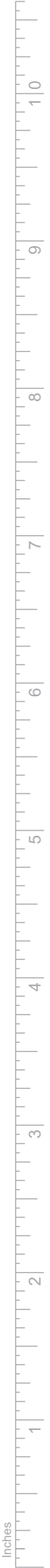

G28

Meissel und Osteotome DE
Bone Chisels and Gouges EN
Cinceles y gubias para huesos ES
الأزاميل العظام والحفارات AR



- G28.0060.06 6mm
- G28.0060.09 9mm
- G28.0060.13 13mm
- G28.0060.16 16mm
- G28.0060.19 19mm
- G28.0060.25 25mm
- G28.0060.32 32mm

SMITH-PETERSEN
20.0cm



- G28.0061.06 6mm
- G28.0061.09 9mm
- G28.0061.13 13mm
- G28.0061.16 16mm
- G28.0061.19 19mm
- G28.0061.25 25mm
- G28.0061.32 32mm

SMITH-PETERSEN
20.0cm



- G28.0064.06 6mm
- G28.0064.09 9mm
- G28.0064.13 13mm
- G28.0064.16 16mm
- G28.0064.19 19mm
- G28.0064.25 25mm
- G28.0064.32 32mm

SMITH-PETERSEN
20.0cm

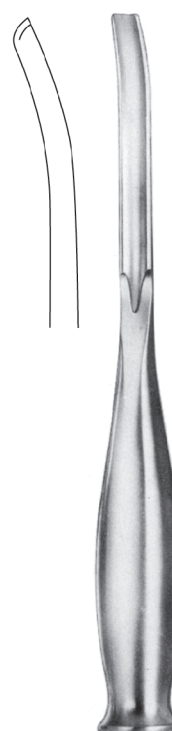

- G28.0065.06 6mm
- G28.0065.09 9mm
- G28.0065.13 13mm
- G28.0065.16 16mm
- G28.0065.19 19mm
- G28.0065.25 25mm
- G28.0065.32 32mm

SMITH-PETERSEN
20.0cm

G28-004 G28.0065.32



DE Meissel und Osteotome

EN Bone Chisels and Gouges

ES Cinceles y gubias para huesos

AR الأزاميل والعظام والحفارات



G28.0070.03 3mm
G28.0070.05 5mm
G28.0070.06 6mm
G28.0070.08 8mm
G28.0070.09 9mm

HOKE
17.0cm



G28.0080.06 6mm
G28.0080.13 13mm
G28.0080.19 19mm
G28.0080.25 25mm
G28.0080.32 32mm

HIBBS
24.0cm



28.0084.06 6mm
28.0084.13 13mm
28.0084.19 19mm
28.0084.25 25mm
28.0084.32 32mm

HIBBS
24.0cm



G28.0081.06 6mm
G28.0081.13 13mm
G28.0081.19 19mm
G28.0081.25 25mm
G28.0081.32 32mm

HIBBS
24.0cm



G28.0086.06 6mm
G28.0086.13 13mm
G28.0086.19 19mm
G28.0086.25 25mm
G28.0086.32 32mm

HIBBS
24.0cm



G28.0087.06 6mm
G28.0087.13 13mm
G28.0087.19 19mm
G28.0087.25 25mm
G28.0087.32 32mm

HIBBS
24.0cm

G28.0087.32 **G28-005**



G28

Meissel und Osteotome **DE**
 Bone Chisels and Gouges **EN**
 Cinceles y gubias para huesos **ES**
 الأزاميل والعظام والحفارات **AR**



- G28.0090.03 3mm
- G28.0090.04 4mm
- G28.0090.06 6mm
- G28.0090.08 8mm
- G28.0090.10 10mm
- G28.0090.12 12mm
- G28.0090.15 15mm

MINI-LAMBOTTE
12.5cm



- G28.0092.03 3mm
- G28.0092.04 4mm
- G28.0092.06 6mm
- G28.0092.08 8mm
- G28.0092.10 10mm
- G28.0092.12 12mm
- G28.0092.15 15mm

MINI-LAMBOTTE
17.0cm



- G28.0094.15 15mm
- G28.0094.20 20mm
- G28.0094.25 25mm
- G28.0094.30 30mm
- G28.0094.38 38mm
- G28.0094.44 44mm
- G28.0094.50 50mm

LAMBOTTE
24.0cm



- G28.0095.15 15mm
- G28.0095.20 20mm
- G28.0095.25 25mm
- G28.0095.30 30mm
- G28.0095.38 38mm
- G28.0095.44 44mm
- G28.0095.50 50mm

LAMBOTTE
23.0cm

G28-006 G28.0095.50

DE Meissel und Osteotome
 EN Bone Chisels and Gouges
 ES Cinceles y gubias para huesos
 AR امتداد الانحناء وإكسسوارات



G28.0100.04 4mm
 G28.0100.06 6mm
 G28.0100.08 8mm
 G28.0100.10 10mm
 G28.0100.12 12mm

MINI-LEXER
18.0cm



G28.0102.04 4mm
 G28.0102.06 6mm
 G28.0102.08 8mm
 G28.0102.10 10mm
 G28.0102.12 12mm

MINI-LEXER
18.0cm

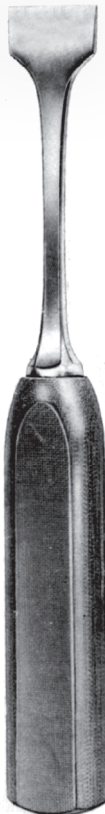

G28.0104.07 7mm
 G28.0104.10 10mm
 G28.0104.15 15mm
 G28.0104.20 20mm
 G28.0104.25 25mm
 G28.0104.30 30mm

LEXER
22.0cm



G28.0106.07 7mm
 G28.0106.10 10mm
 G28.0106.15 15mm
 G28.0106.20 20mm
 G28.0106.25 25mm
 G28.0106.30 30mm

LEXER
22.0cm

G28.0087.32 **G28-005**





LEXER
25.0cm

- G28.0110.05 5mm
- G28.0110.10 10mm
- G28.0110.15 15mm



LEXER
25.0cm

- G28.0111.05 5mm
- G28.0111.10 10mm
- G28.0111.15 15mm



DE	Hammer
EN	Mallets
ES	Martillos y mazos
AR	المطارق



MEAD
G28.0120.17 17.0cm
26mm Ø, 320 g (11¼ oz)

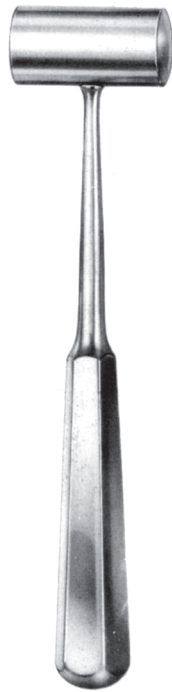

PARTSCH
G28.0124.18 18.0cm
22mm Ø, 200 g (7 oz)

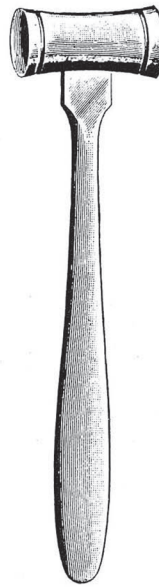

G28.0130.30
30mm Ø, 510 g

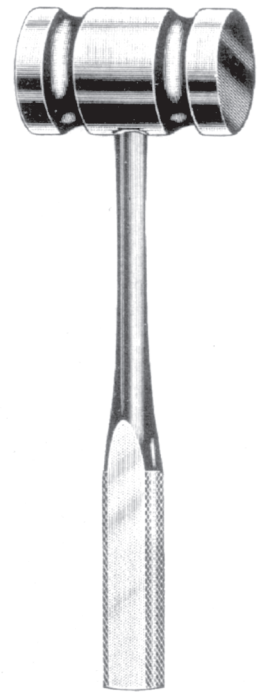

G28.0134.25 250 g
G28.0134.45 450 g
G28.0134.90 900 g
26.5cm



G28

Hämmer DE

Mallets EN

Martillos y mazos ES

المطارق AR

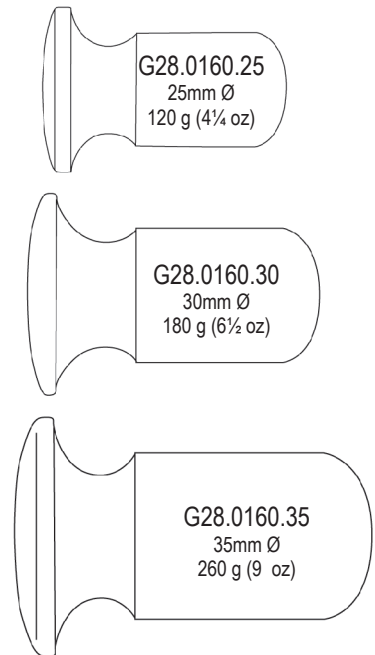
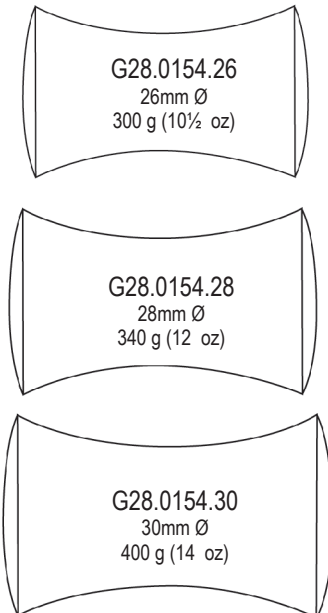
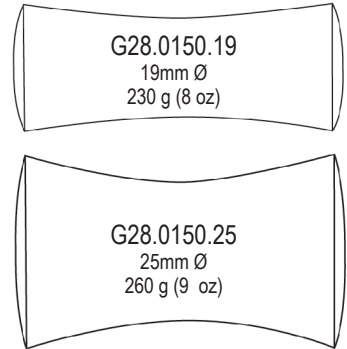

G28-010 G28.0160.35



DE Hammer
EN Mallets
ES Martillos y mazos
AR المطارق

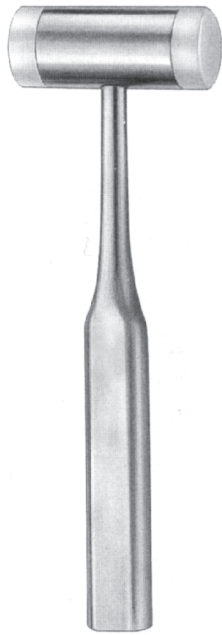

G28.0164.18 18.5cm
25mm Ø 135 g

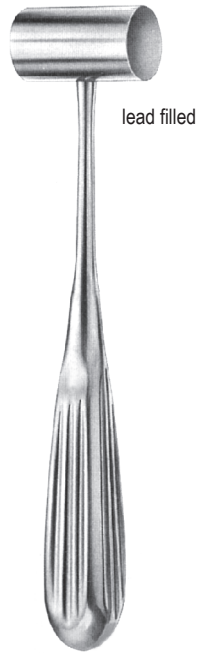

G28.0170.19 19.0cm
22mm Ø 155 g



HAJEK
G28.0174.22 22.0cm
27mm Ø 130 g



GERZOG
G28.0180.18 18.0cm
250 g

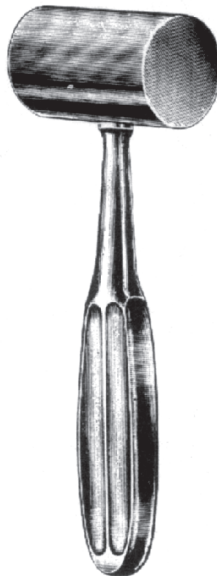

KIRK
G28.0184.19 19.0cm
750 g

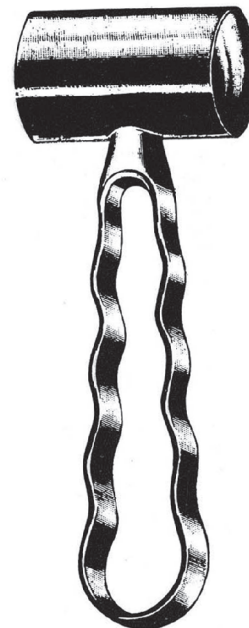

HEATH
18.0cm
G28.0188.35 35mm Ø (28 oz)
G28.0188.40 40mm Ø (36 oz)

G28.0188.40 **G28-011**



G28

Hämmer DE

Mallets EN

Martillos y mazos ES

المطارق AR

G28.0200.00
spare faces

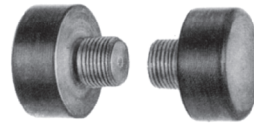

G28.0190.26
26.5cm 530 g (19 oz)

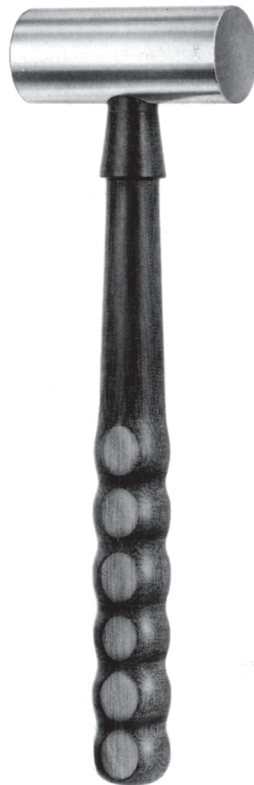

G28.0194.24
24.0cm (30mm Ø 480 g)



G28.0200.22
22.5cm (37mm Ø 370 g)



G28.0204.24 24.0cm

G28-012 G28.0204.24

DE Hammer
EN Mallets
ES Martillos y mazos
AR المطارق



G28.0210.26 26.5cm
30mm Ø, 510 g (18 oz)



G28.0214.26 26.5cm



G28.0220.25 26.5cm 250 g (0.55 lbs)
G28.0220.45 26.5cm 450 g (1 lbs)
G28.0220.90 26.5cm 900 g (2 lbs)

G28.0220.90 **G28-013**



G28

Scharfe Löffel DE

Bone Currettes EN

Cucharilla cortantes ES

المجرفة العظام AR



WILLIGER
17.5cm

Fig. 00
G28.0300.20

Fig. 0
G28.0300.10

Fig. 01
G28.0300.01

Fig. 02
G28.0300.02

Fig. 00
G28.0302.20

Fig. 0
G28.0302.10

Fig. 01
G28.0302.01

Fig. 02
G28.0302.02



BRUNS
23.0cm

G28.0306.30

G28.0306.10

G28.0306.02

G28.0306.04

G28.0306.06

G28.0306.20

G28.0306.01

G28.0306.03

G28.0306.05



SIMON
24.0cm

G28.0310.01

G28.0310.03

G28.0310.05

G28.0310.02

G28.0310.04

G28.0310.06



DE Scharfe Löffel
EN Bone Currettes
ES Cucharilla cortantes
AR المجرفة العظام

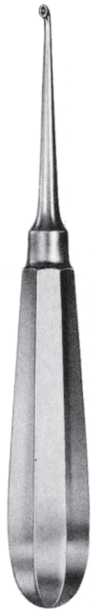

MOD. USA
16.0cm

Fig.1

Fig.2

Fig.03

Fig.04

Fig.05

Fig.06

Fig.1 G28.0320.01
Fig.2 G28.0320.02
Fig.3 G28.0320.03
Fig.4 G28.0320.04
Fig.5 G28.0320.05
Fig.6 G28.0320.06

G28.0322.01
G28.0322.02
G28.0322.03
G28.0322.04
G28.0322.05
G28.0322.06

G28.0324.01
G28.0324.02
G28.0324.03
G28.0324.04
G28.0324.05
G28.0324.06



LEMPERT
17.5cm

Fig.0

Fig.00

Fig.000

Fig.0000

Fig.00000

Fig.0 G28.0330.10
Fig.00 G28.0330.20
Fig.000 G28.0330.30
Fig.0000 G28.0330.40
Fig.00000 G28.0330.50



HALLE
21.0cm

G28.0334.01

G28.0334.02

G28.0334.03



25.0cm

G28.0340.01

G28.0340.02

G28.0340.03



G28

Scharfe Löffel DE

Bone Curettes EN

Cucharilla cortantes ES

المجرفة العظام AR



VOLKMANN
17.0cm

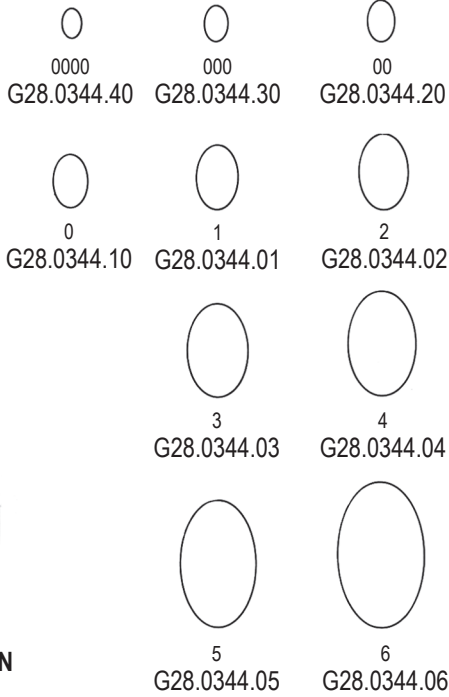

BRUNS
17.0cm

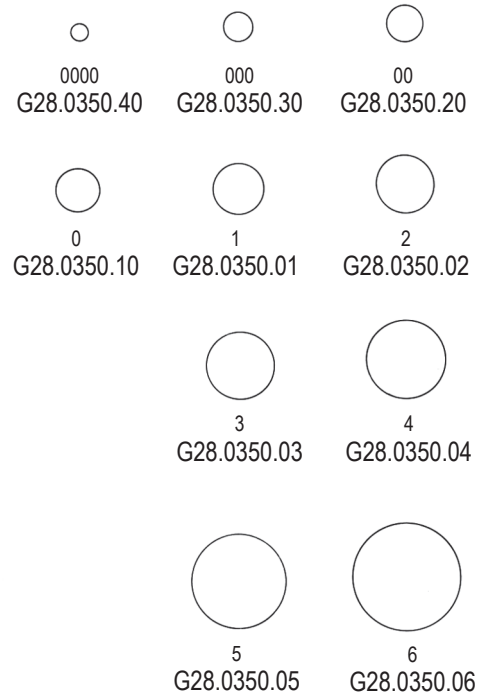

SCHEDE
17.0cm

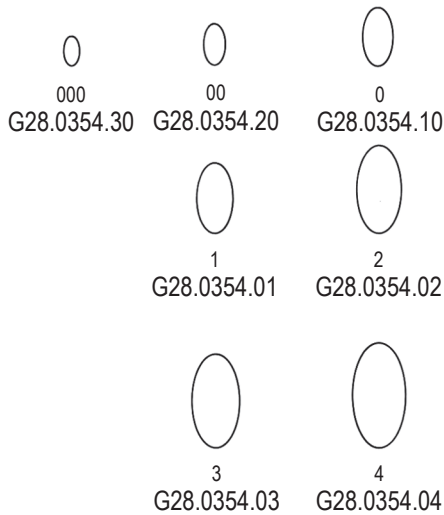

SPRATT
16.5cm

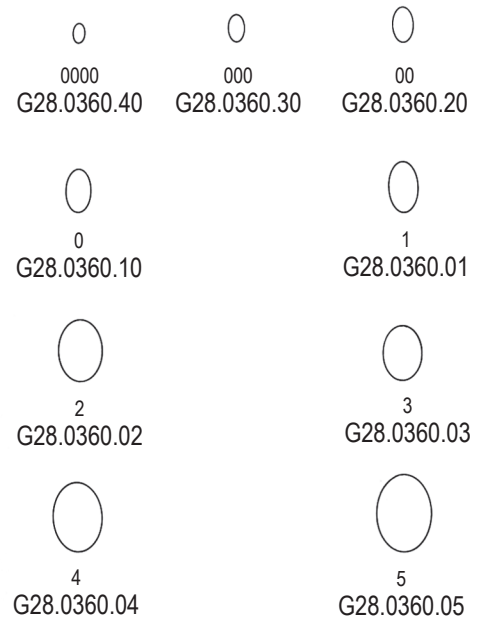

G28-016 G28.0360.05



DE Scharfe Löffel
EN Bone Currettes
ES Cucharilla cortantes
AR المجرفة العظام

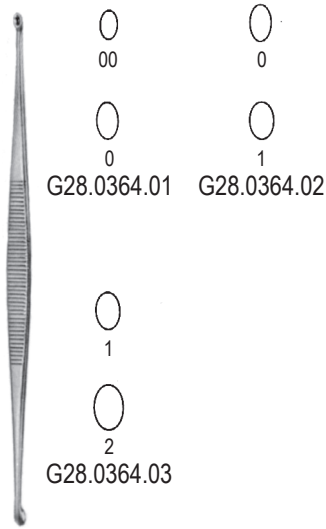

G28.0364.01 G28.0364.02

G28.0364.03

WILLIGER
13.5cm

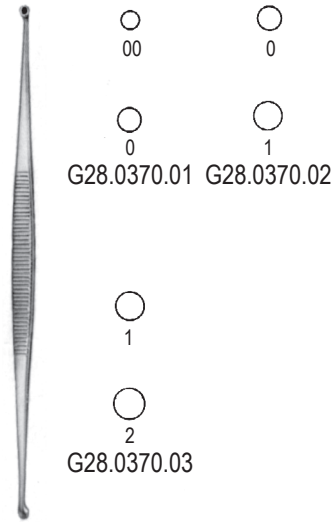

G28.0370.01 G28.0370.02

G28.0370.03

MARTINI
13.5cm

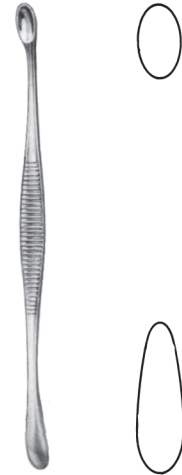

VOLKMANN
G28.0374.13 13.0cm
G28.0374.14 14.0cm
G28.0374.17 17.0cm



VOLKMANN
G28.0380.13 13.0cm
G28.0380.16 16.0cm
G28.0380.20 20.0cm



G28.0384.21 21.0cm

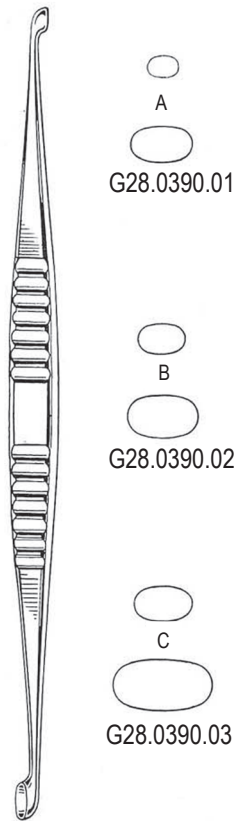

VOLKMANN
21.5cm

G28.0390.03 **G28-017**



G28

Scharfe Löffel DE

Bone Currettes EN

Cucharilla cortantes ES

المجرفة العظام AR



VOLKMANN
17.0cm



VOLKMANN
27.0cm

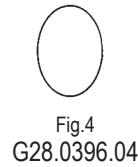
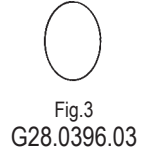
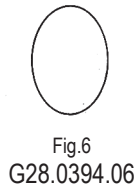
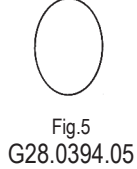
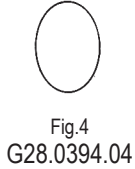
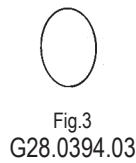
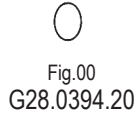
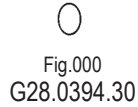
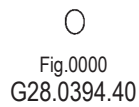

G28-018 G28.0396.04



- DE Knochenfeile
- EN Bone Files
- ES Lima para huesos
- AR عرموش العظم



G28.0400.22 22.0cm

G28.0404.24 24.5cm

G28.0410.28 28.0cm

PUTTI
G28.0414.30 30.0cm

PUTTI
G28.0416.27 27.0cm

G28

Raspatorien DE

Periosteal Raspatories EN

Legras periostotomos ES

مسحاح السمحاق AR

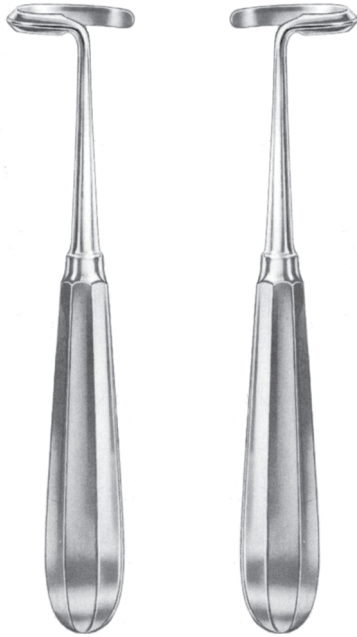

DOYEN
17.0cm

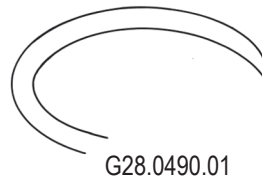

G28.0490.01



G28.0490.02



G28.0492.01

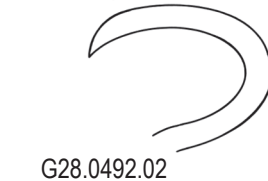

G28.0492.02

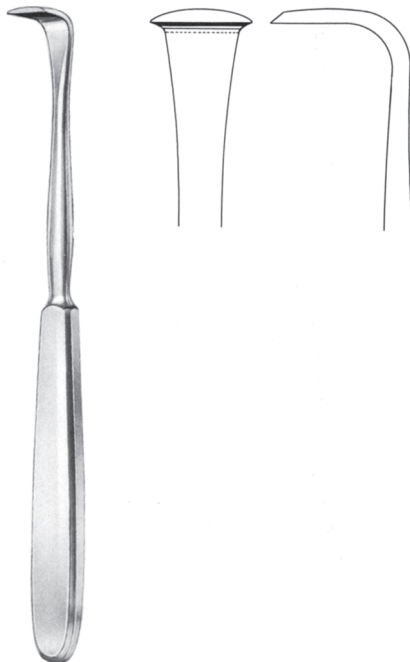

LANGENBECK
G28.0500.18 18.0cm

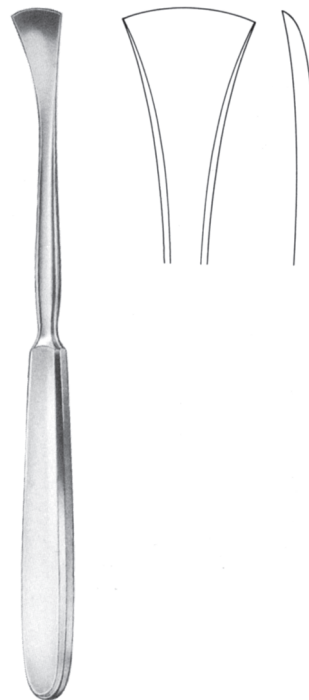

LANGENBECK
G28.0502.19 19.0cm



G28.0506.10 10mm
G28.0506.15 15mm
G28.0506.20 20mm
G28.0506.25 25mm

LAMBOTTE
21.0cm

G28-022 G28.0506.25



DE Raspatorien
EN Periosteal Raspatories
ES Legras periostotomos
AR مسحات السمحاق



SEMB

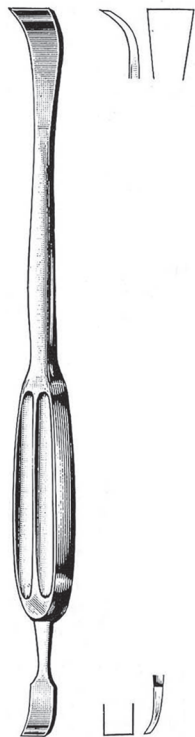

DAVIDSON-ALEXANDER
G28.0474.29 29.0cm

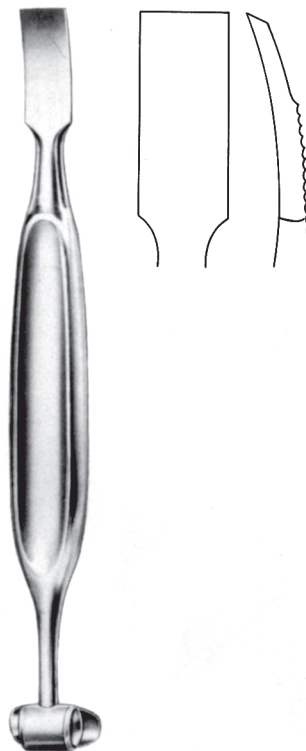

ALEXANDER
G28.0480.20 20.0cm

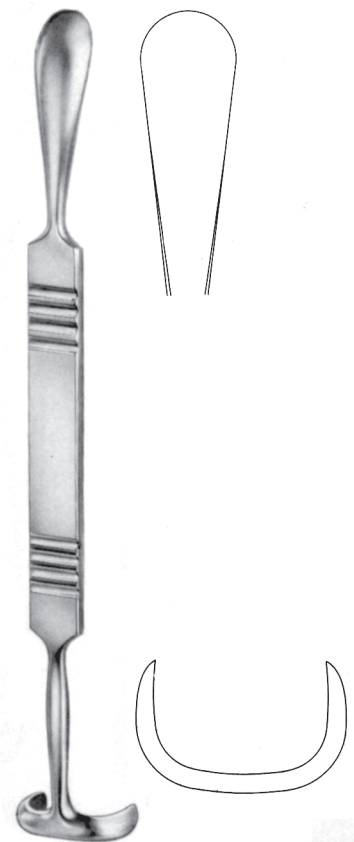

MATSON
G28.0484.22 22.0cm

G28.0484.22 **G28-021**



G28

Raspatorien DE

Periosteal Raspatories EN

Legras periostotomos ES

مسحاح السمحاق AR

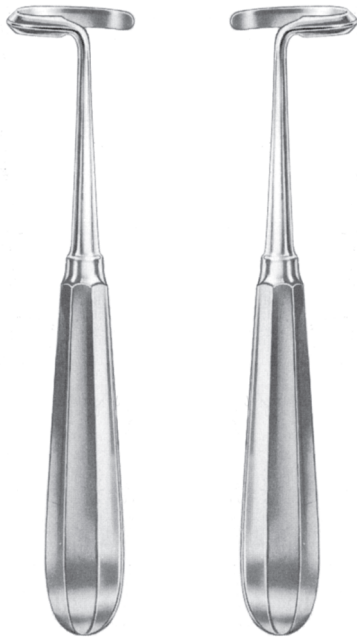

DOYEN
17.0cm

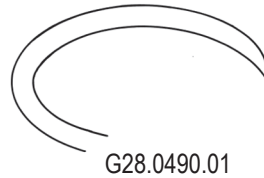

G28.0490.01



G28.0490.02



G28.0492.01

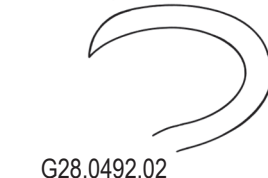

G28.0492.02

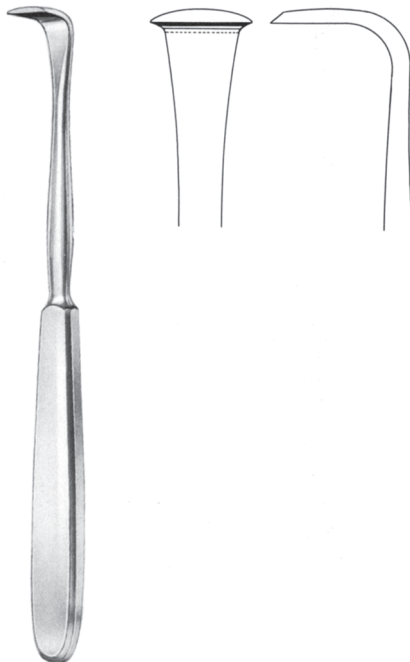

LANGENBECK
G28.0500.18 18.0cm

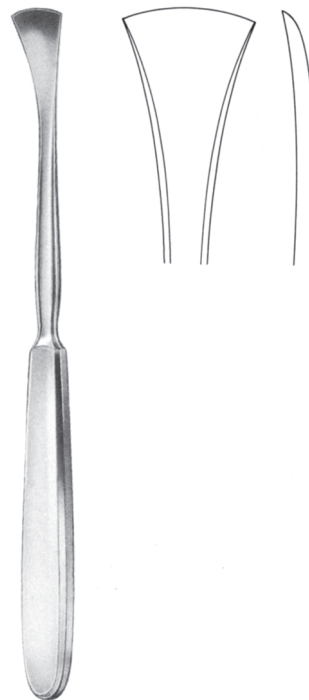

LANGENBECK
G28.0502.19 19.0cm



G28.0506.10 10mm
G28.0506.15 15mm
G28.0506.20 20mm
G28.0506.25 25mm

LAMBOTTE
21.0cm

G28-022 G28.0506.25



DE Raspatorien
EN Periosteal Raspatories
ES Legras periostotomos
AR مسحات السمحاق



G28.0510.04 4mm
G28.0510.06 6mm

CUSHING
17.0cm



G28.0512.05 5mm
G28.0512.07 7mm

CUSHING
19.5cm



G28.0516.07 7mm, 16.0cm
G28.0516.15 15mm, 18.5cm
G28.0516.20 20mm, 19.0cm

HOEN

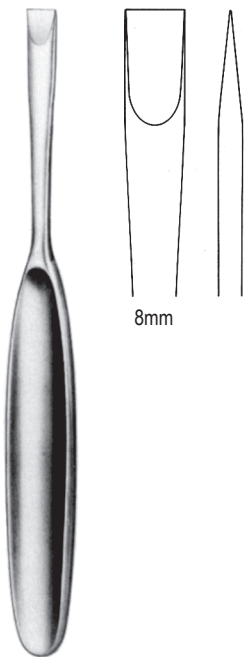

8mm

CUSHING
G28.0520.17 17.0cm

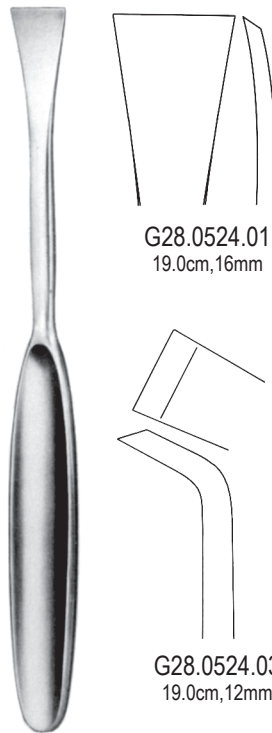

G28.0524.01
19.0cm, 16mm



G28.0524.02
19.0cm, 16mm

G28.0524.03
19.0cm, 12mm

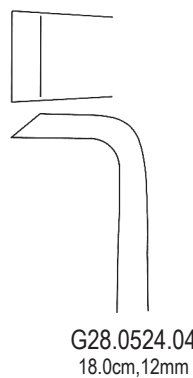

G28.0524.04
18.0cm, 12mm

LANGENBECK

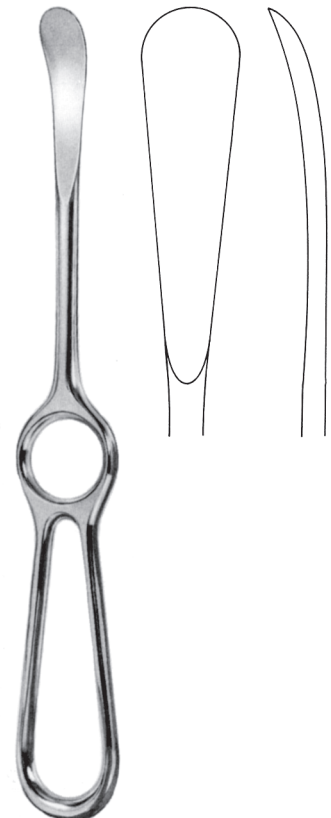

SEDILLOT
G28.0530.21 21.0cm

G28.0530.21 **G28-023**



G28

Raspatorien DE

Periosteal Raspatories EN

Legras periostotomos ES

مسحاق السمحاق AR

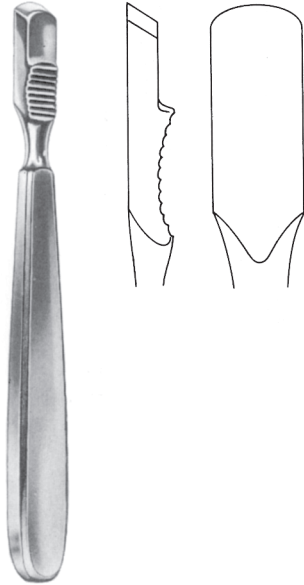

FARABEU
G28.0534.15 15.0cm

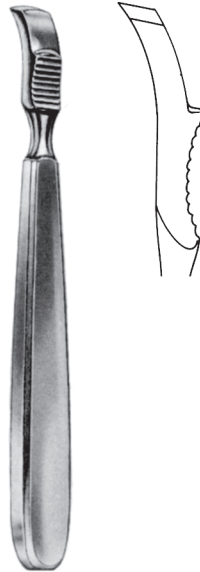

FARABEU
G28.0535.15 15.0cm



17.0cm

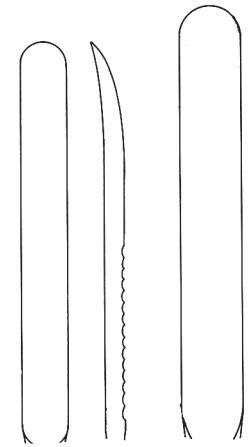

G28.0540.06 6mm
G28.0540.08 8mm

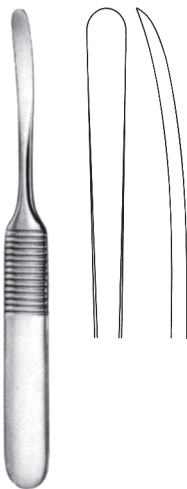

WILLIGER
G28.0544.13 13.0cm

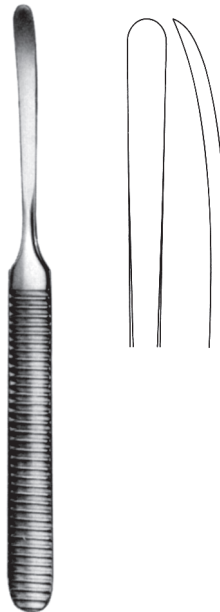

WILLIGER
G28.0546.16 16.0cm



G28.0550.05
5mm



G28.0550.06
6mm



G28.0550.07
7mm

G28-024 G28.0550.07



DE Raspatorien
EN Periosteal Raspatories
ES Legras periostotomos
AR مسحات السمحاق



G28.0554.27 27.5cm
20mm

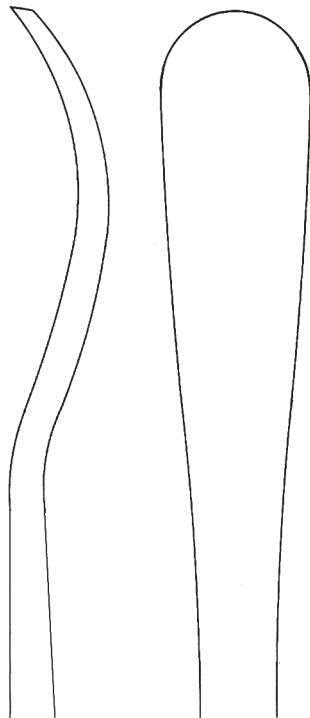

WAGNER
33.0cm
G28.0560.08 8mm
G28.0560.17 17mm

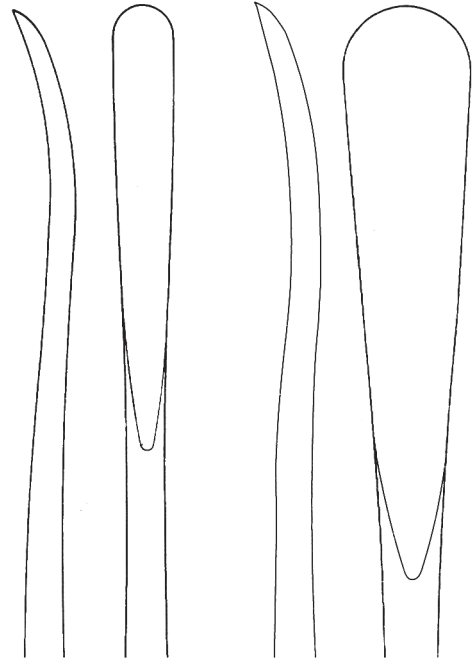

G28.0560.17 **G28-025**



G28

Raspatorien DE

Periosteal Raspatories EN

Legras periostotomos ES

مسحاح السمحاق AR



G28.0564.18 18.0cm



G28.0570.18 18.0cm



G28.0572.18 18.0cm



G28.0574.19 19.0cm



G28.0576.18 18.5cm



G28.0580.20 20.0cm



G28.0581.20 20.0cm

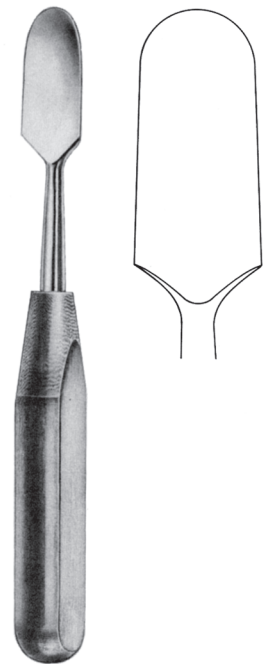

G28.0584.20 20.0cm

G28-026 G28.0584.20



DE Raspatorien
EN Periosteal Raspatories
ES Legras periostotomos
AR مسحات السمحاق



COBB

24.0cm		28.0cm	
G28.0590.10	10mm	G28.0592.10	10mm
G28.0590.13	13mm	G28.0592.13	13mm
G28.0590.19	19mm	G28.0592.19	19mm
G28.0590.25	25mm	G28.0592.25	25mm
G28.0590.32	32mm	G28.0592.32	32mm



COBB

27.0cm	
G28.0594.04	4mm
G28.0594.06	6mm
G28.0594.08	8mm



COBB

28.0cm	
G28.0596.08	8mm
G28.0596.10	10mm
G28.0596.12	12mm

G28.0596.12 **G28-027**



G28

Elevatoren DE

Elevators EN

Elevadores ES

رافعة العظم AR



G28.0600.16 16.0cm



G28.0604.17 17.5cm



G28.0610.06 6mm
G28.0610.12 12mm
G28.0610.19 19mm
G28.0610.25 25mm

KEY
19.0cm



ALDERDYCE
G28.0614.21 21.0cm

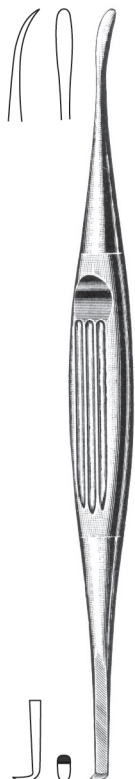

OVERHOLT
G28.0620.29 29.5cm

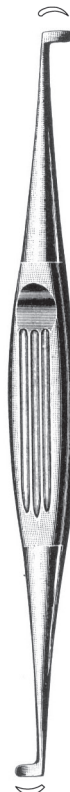

OVERHOLT
G28.0622.29 29.5cm

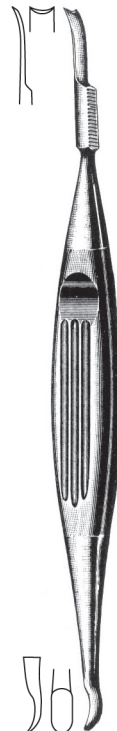

OVERHOLT
G28.0624.28 28.5cm

G28-028 G28.0624.28

DE Elevatorien
EN Elevators
ES Elevadores
AR رافعة العظم

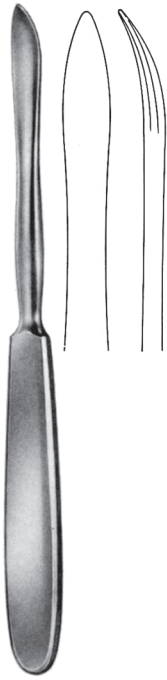

LANGENBECK
20.0cm
G28.0630.08 8mm
G28.0630.10 10mm



LANGENBECK

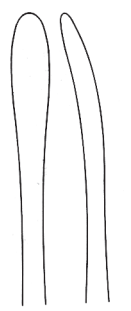

G28.0632.05
17.0cm, 5mm



G28.0632.07
17.0cm, 7mm

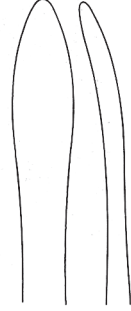

G28.0632.08
20.0cm, 8mm

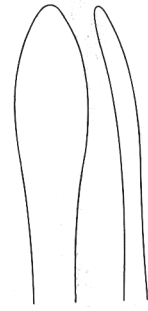

G28.0632.10
20.0cm, 10mm

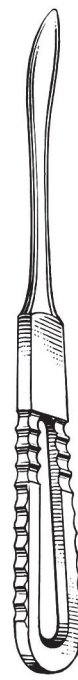

ST. THOMAS
G28.0636.18 18.0cm



ADSON
17.0cm

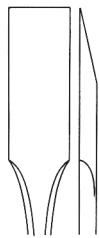

G28.0640.01



G28.0640.02



G28.0640.03



G28.0640.04



WILLIGER
17.0cm



G28.0644.17



WILLIGER
16.0cm



G28.0646.16



G28.0648.16
16.0cm

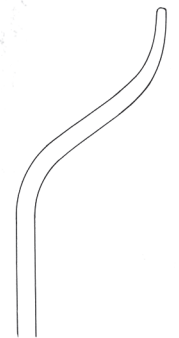

G28.0648.16 **G28-029**



G28

Knochenheber DE

Bone Levers EN

Elevadores para huesos ES

دعامتين العظام AR



LANE
G28.0650.26 26.5cm



LANE TRETOWAN
G28.0652.21 21.5cm



LANE
G28.0654.25 25.5cm



BRISTOW
G28.0660.23 23.0cm



MURPHY-LANE
G28.0664.34 34.0cm

G28-030 G28.0664.34



DE Knochenhebel
EN Bone Levers
ES Elevadores para huesos
AR دعامة العظام

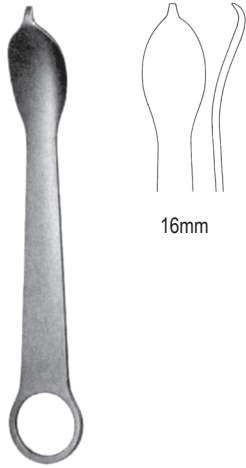

G28.0670.12 12.0cm

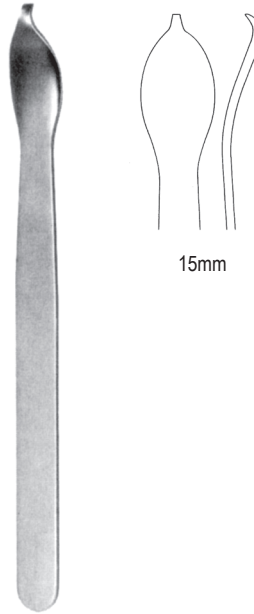

G28.0674.16 16.0cm

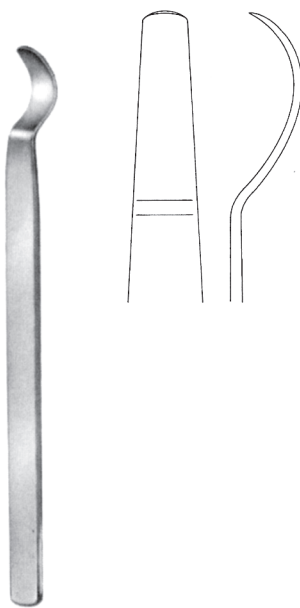

G28.0680.14 14.0cm



G28.0684.06

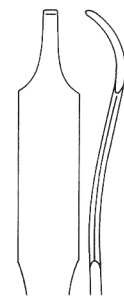

G28.0684.08

MINI-HOHMANN
16.0cm



G28

Knochenheber DE

Bone Levers EN

Elevadores para huesos ES

دعامتين العظام AR



HOHMANN
G28.0690.08 8mm

HOHMANN
G28.0690.18 18mm

HOHMANN
G28.0690.43 43mm

HOHMANN
G28.0690.70 70mm

G28-032 G28.0690.70

DE Knochenhebel
EN Bone Levers
ES Elevadores para huesos
AR دعامتین العظام



HOHMANN
G28.0692.43 43mm

HOHMANN
G28.0694.22 22mm

HOHMANN
G28.0694.33 33mm

HOHMANN
G28.0696.24 24mm

LANGE-HOHMANN
G28.0698.22 22mm

G28.0698.22 **G28-033**



G28

Knochenheber DE

Bone Levers EN

Elevadores para huesos ES

دعامتين العظام AR



LANGE-HOHMANN
G28.0700.27 27.0cm
G28.0700.29 29.0cm



LANGE-HOHMANN
G28.0702.27 27.0cm
G28.0702.29 29.0cm



BENNETT
G28.0710.24 24.0cm
G28.0710.26 26.0cm



BENNETT
G28.0712.24 24.0cm
G28.0712.26 26.0cm



BLOUNT
G28.0720.26 26.0cm



BLOUNT
G28.0722.26 26.0cm



BLOUNT
G28.0724.17 17.5cm



TAYLOR
16.5cm
G28.0730.75 75x30mm
G28.0730.10 100x30mm

G28-034 G28.0730.10



DE Wundhaken
EN Bone Retractors
ES Separadores
AR الكامشات



SMILLIE
14.0cm



G28.0734.01
32x19mm



G28.0734.02
48x19mm



G28.0734.03
57x19mm



G28.0734.04
52x13mm



G28.0734.05
12x13mm



G28.0740.17
17.0cm, 56x10mm



G28.0744.22
22.0cm, 38x9mm



G28

Meniskotome DE

Meniscotomy Knives EN

Bisturios para meniscos ES

السكاكين استئصال الهلالية AR



SMILLIE
17.0cm



G28.0750.01



G28.0750.02



G28.0750.03



MOD. SCHWEDEN
17.0cm



left cutting
G28.0754.01



right cutting
G28.0754.02



BIRCHER
19.0cm



G28.0760.01



G28.0760.02

G28-036 G28.0760.02

DE Meniskotome

EN Meniscotomy Knives

ES Bisturías para meniscos

AR السكاكين استئصال الهلالية



G28.0764.18
18.0cm



G28.0770.01



G28.0770.02

NEFF
22.0cm



SALENIUS
G28.0774.01 22.0cm



SALENIUS
G28.0774.02 22.0cm



LOWE-BRECK
G28.0780.25 25.0cm



DOWNING
G28.0784.25 25.0cm

G28.0784.25 **G28-037**



G28

Sequester und knorpelfasszangen DE
Sequestrum and Cartilage seizing Forceps EN
Pinzas para secuestros y cartilago ES
الملقط شنظ والغضروف الاستيلاء على AR

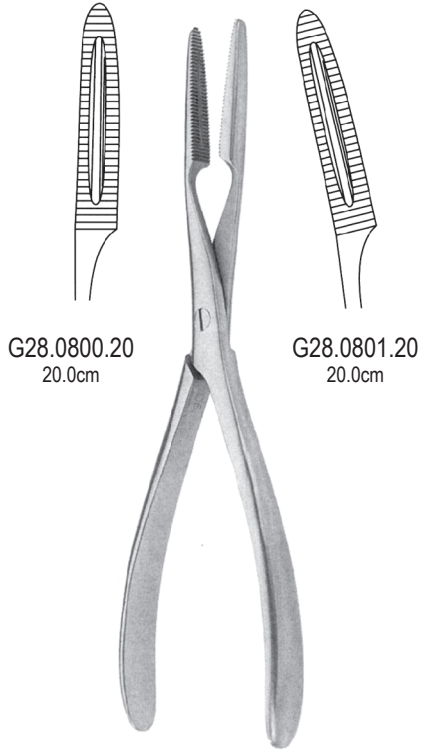

G28.0800.20
20.0cm

G28.0801.20
20.0cm



G28.0806.23
23.0cm

VAN BUREN

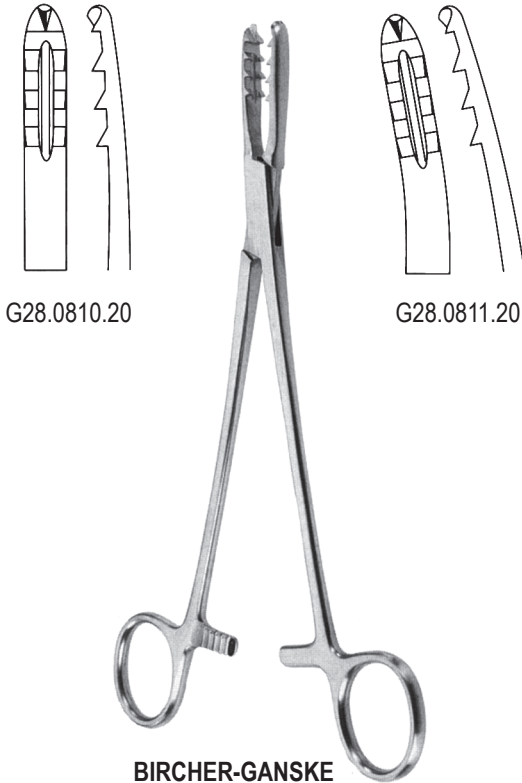

G28.0810.20

G28.0811.20

BIRCHER-GANSKE
20.0cm



G28.0816.19

MARTIN
19.0cm

G28-038 G28.0816.19

DE Knochenhaltezangen
EN Bone Holding Forceps
ES Pinzas para huesos
AR الملقط عظم القابضة

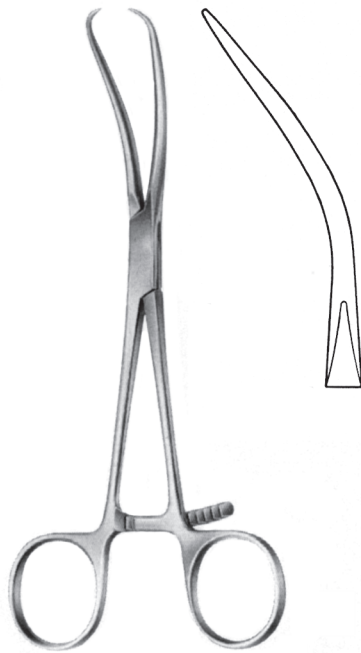

REILL
G28.0820.17 17.0cm

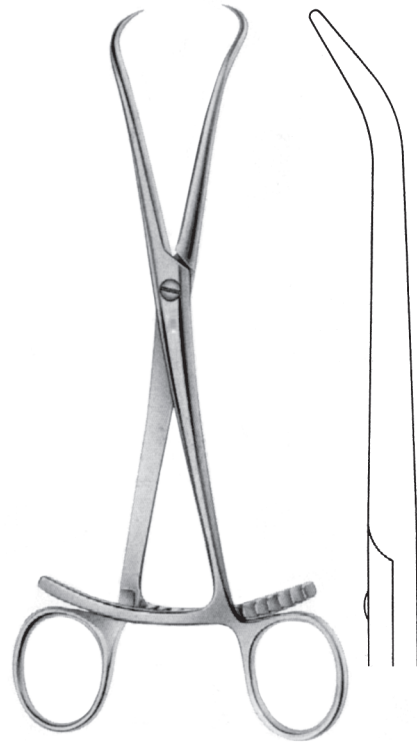

G28.0824.20 20.5cm

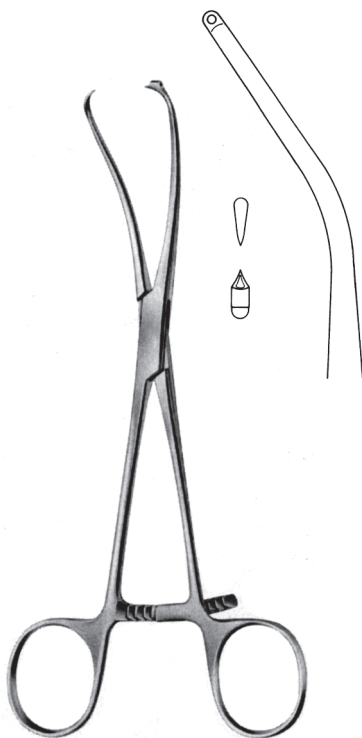

MEYER
G28.0830.17 17.0cm



G28.0834.21 21.0cm

G28.0834.21 **G28-039**



G28

Knochenhaltezangen DE

Bone Holding Forceps EN

Pinzas para huesos ES

الملقط عظم القابضة AR



DINGMANN
G28.0840.19 19.0cm



DINGMANN (Modif)
G28.0842.19 19.0cm



LEWIN
G28.0846.17 17.5cm

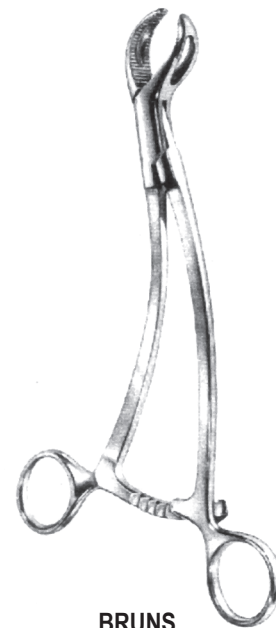

BRUNS
G28.0850.18 18.5cm

G28-040 G28.0850.18



DE Knochenhaltezaugen
EN Bone Holding Forceps
ES Pinzas para huesos
AR الملقط عظم القابضة



G28.0854.13 13.5cm



G28.0860.12 12.0cm



G28.0864.13 13.5cm



G28.0870.14 14.0cm

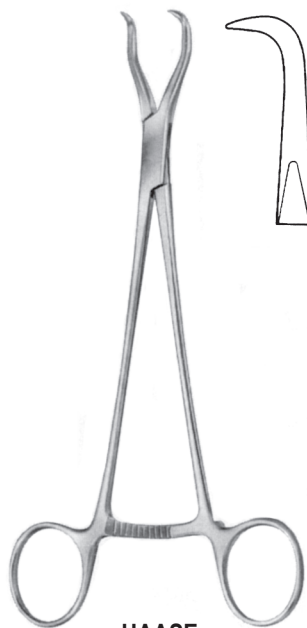

HAASE
G28.0874.16 16.5 cm

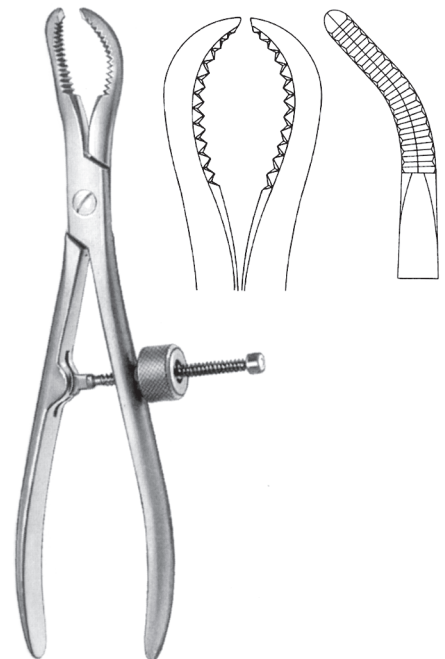

G28.0880.16 16.0 cm
G28.0880.24 24.0cm

G28.0880.24 **G28-041**





G28.0890.19 19.0cm



G28.0890.23 23.0cm



G28.0892.25 25.0cm



DE Knochenhaltezangen
EN Bone Holding Forceps
ES Pinzas para huesos
AR الملقط عظم القابضة



G28.0896.18 18.5cm



G28.0900.40 40.0cm

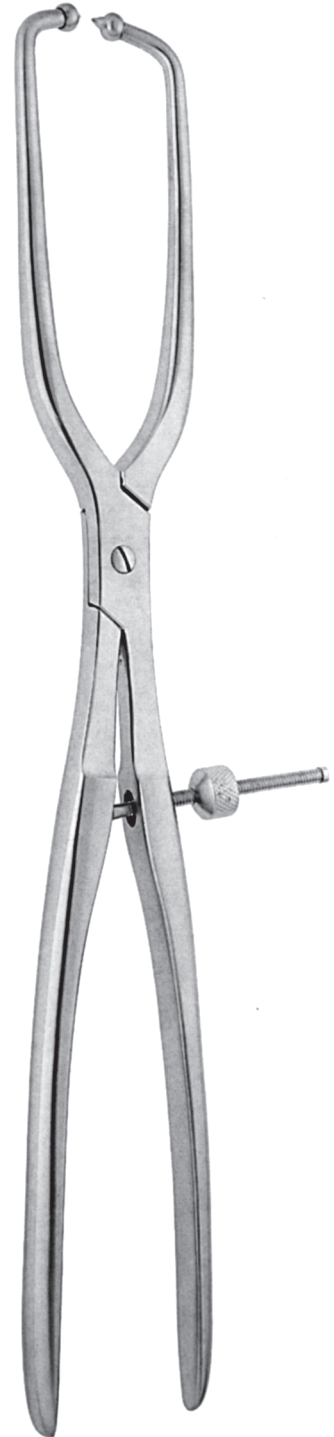

G28.0902.40 40.0cm

G28.0902.40 **G28-043**



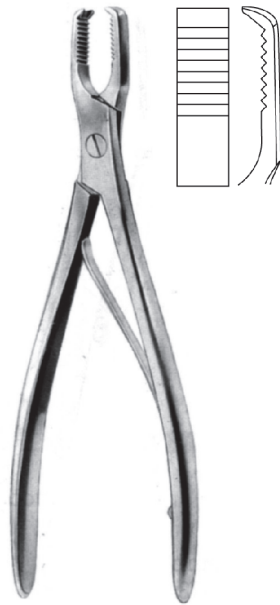

FROSCH
G28.0910.18 18.0cm



FERGUSSON
G28.0914.21 21.0cm

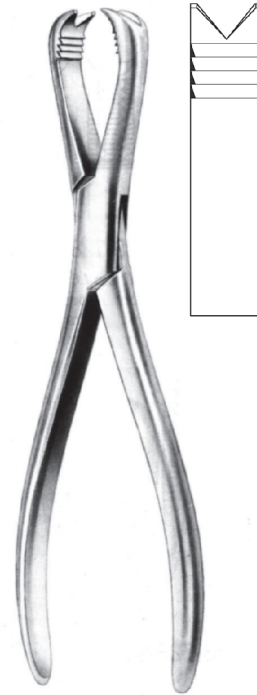

LANGENBECK
G28.0920.21 21.0cm



G28.0924.20 20cm



SEMB
G28.0930.19 19.0cm



SEMB
G28.0934.19 19.0cm

G28-044 G28.0934.19



DE Knochenhaltezaugen
EN Bone Holding Forceps
ES Pinzas para huesos
AR الملقط عظم القابضة

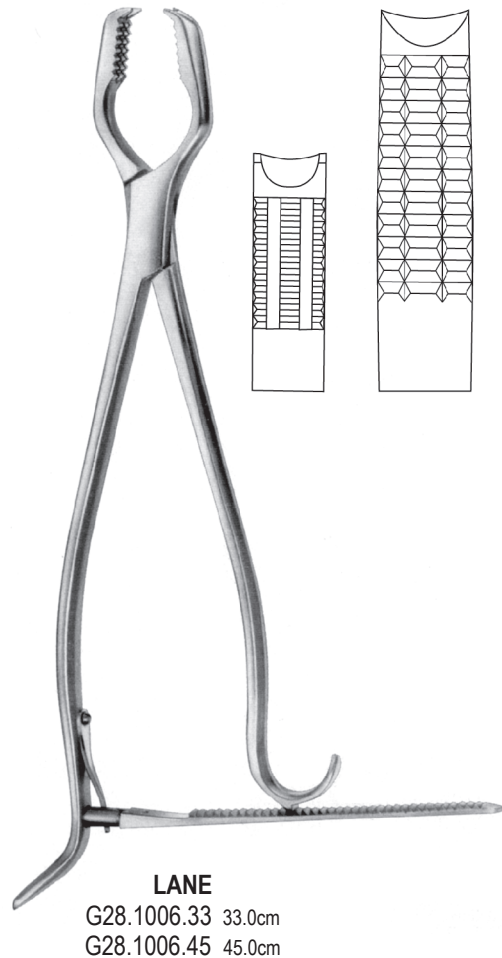
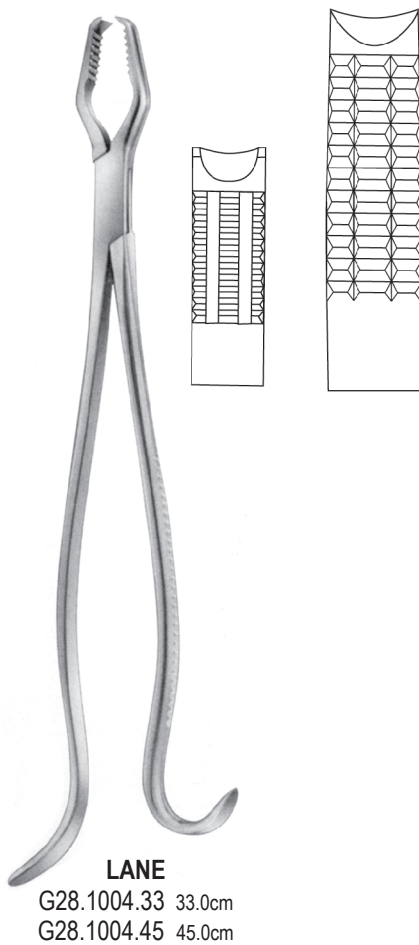
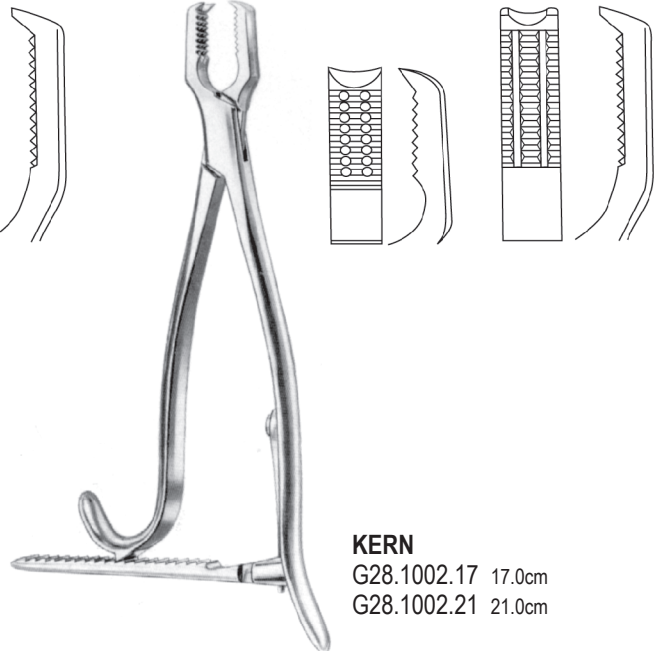

G28.1006.45 **G28-045**





FARABEU
G28.1010.23 23.0cm
G28.1010.26 26.0cm



FARABEU-LAMBOTTE
G28.1014.26 26.0cm



TUFFIER
G28.1020.27 27.0cm



DE Knochenhalte­zangen
EN Bone Holding Forceps
ES Pinzas para huesos
AR الملقط عظم القابضة



LAMBOTTE

G28.1030.22 22.0cm
G28.1030.27 27.0cm
G28.1030.30 30.0cm

LAMBOTTE

G28.1032.22 22.0cm
G28.1032.26 26.0cm
G28.1032.33 33.0cm

LAMBOTTE

G28.1034.19 19.0cm
G28.1034.23 23.0cm
G28.1034.26 26.0cm

G28

Knochenhaltezangen DE
Bone Holding Forceps EN
Pinzas para huesos ES
الملقط عظم القابضة AR



ULRICH
G28.1040.23 - G28.1040.28

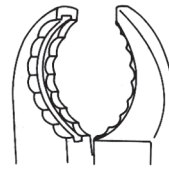
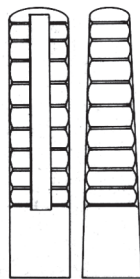

G28.1040.23 23.0cm
G28.1044.22 22.0cm

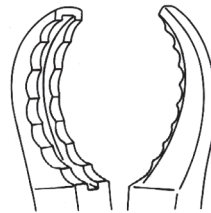

G28.1040.25 25.0cm
G28.1044.24 24.0cm

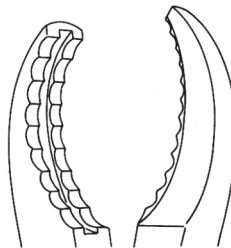

G28.1040.28 28.0cm
G28.1044.27 27.0cm



ULRICH
G28.1044.22 - G28.1044.27

G28-048 G28.1044.27



DE Knochenhalte­zangen
EN Bone Holding Forceps
ES Pinzas para huesos
AR الملقط عظم القابضة



G28.1050.19 19.0cm
G28.1050.26 26.0cm



ULRICH
G28.1054.28 28.0cm

G28.1054.28 **G28-049**



G28

Knochenhaltezangen	DE
Bone Holding Forceps	EN
Pinzas para huesos	ES
الملقط عظم القابضة	AR

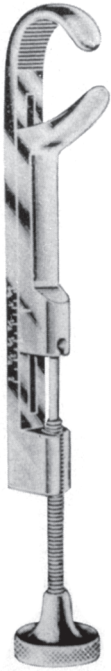

LOWMAN

- G28.1060.12 12.0cm
- G28.1060.18 18.5cm
- G28.1060.20 20.0cm
- G28.1060.22 22.0cm



GERSTER-LOWMANN

- G28.1064.18 18.0cm
- G28.1064.20 20.0cm
- G28.1064.22 22.0cm

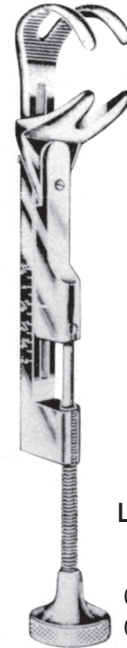

LAMBERT-LOWMAN

- 2x2 prongs
- G28.1070.18 18.0cm
- G28.1070.20 20.0cm
- G28.1070.22 22.0cm



LOWMAN-HOGLUND

- G28.1074.12 12.0cm
- G28.1074.17 17.5cm
- G28.1074.20 20.0cm
- G28.1074.22 22.0cm

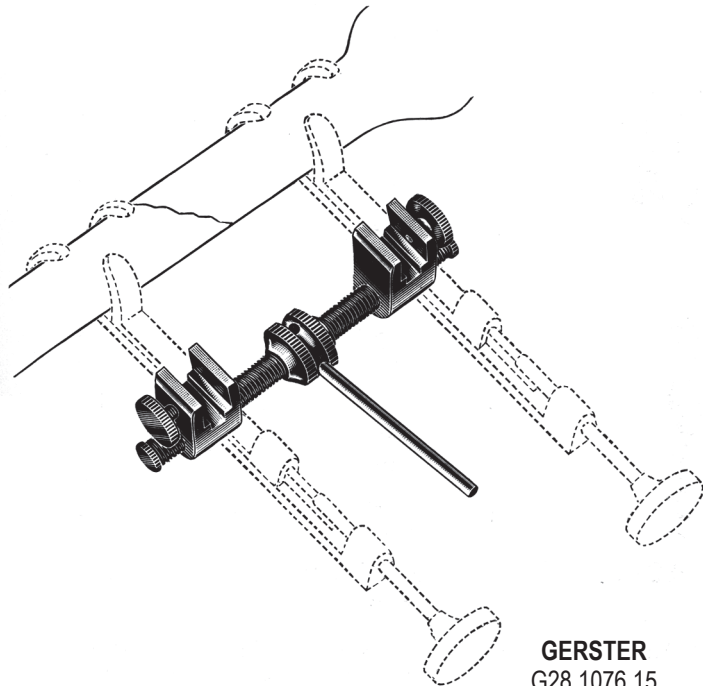

GERSTER
G28.1076.15

G28-050 G28.1076.15



DE Knochenhaltezangen
EN Bone Holding Forceps
ES Pinzas para huesos
AR الملقط عظم القابضة



VERBRUGGE
G28.1080.17 17.5cm

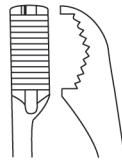

VERBRUGGE
G28.1082.17 17.5cm

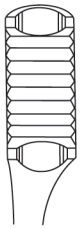

VERBRUGGE

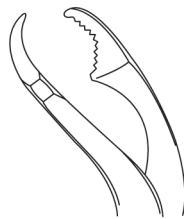

G28.1084.25 25.0cm

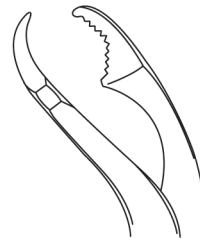

G28.1084.26 26.0cm

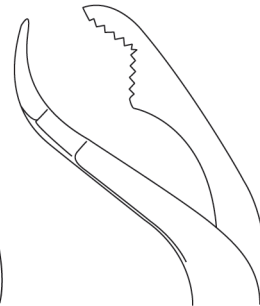

G28.1084.27 27.0cm

G28.1084.27 **G28-051**



G28

Knochenhaltezangen DE

Bone Holding Forceps EN

Pinzas para huesos ES

الملقط عظم القابضة AR

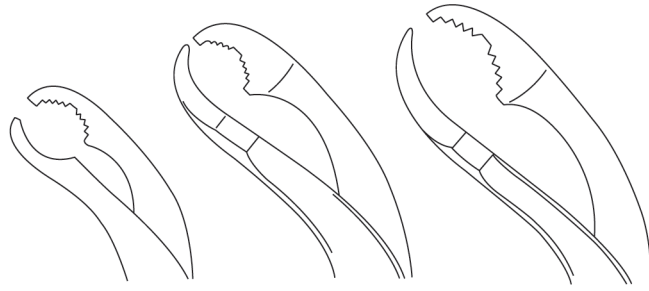
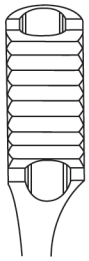

G28.1090.15 15.0cm

G28.1090.19 19.0cm

G28.1090.24 24.0cm

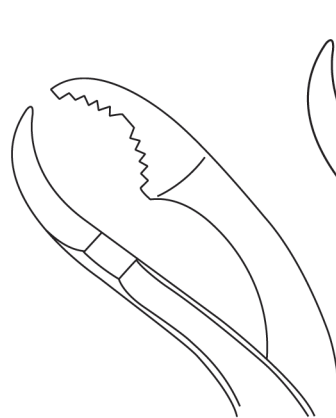

G28.1090.26 26.0cm

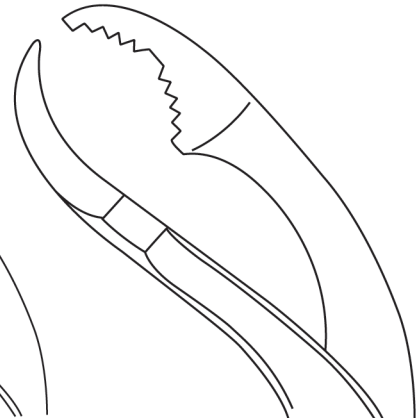

G28.1090.28 28.0cm

G28-052 G28.1090.28



DE Amputationsschild
EN Amputation Retractor
ES Retractor para amputación
AR الكامشات البتر

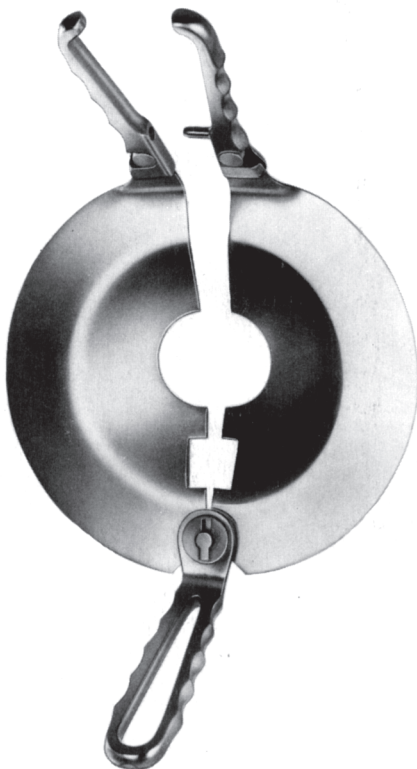

PERCY
G28.1094.00

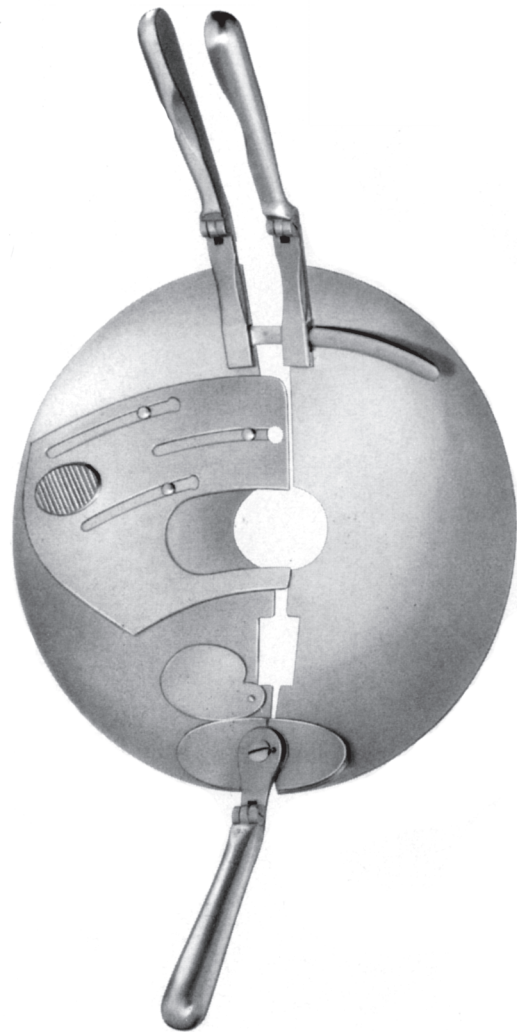

PERCY
G28.1096.00



G28

Sehnenstripper, Durchzug DE

Tendon Stripper, Tendon Tunnel EN

Separadores para tendones, para el tunel del tendon ES

وتر المتعرية وترنفق AR



BUNNELL
15.0cm



23.0cm



G28.1110.33 33.5cm



G28.1110.01
screw only

- G28.1100.01
3mm
- G28.1100.02
4mm
- G28.1100.03
5mm
- G28.1100.04
6mm
- G28.1100.05
7mm

- G28.1104.40
4mm
- G28.1104.45
4.5mm
- G28.1104.55
5.5mm

DE Sehnenstripper, Durchzug

EN Tendon Stripper, Tendon Tunnel

ES Separadores para tendones, para el túnel del tendón

AR وترالمتعرية وترنفق



BUNNEL
G28.1114.23 23.0cm

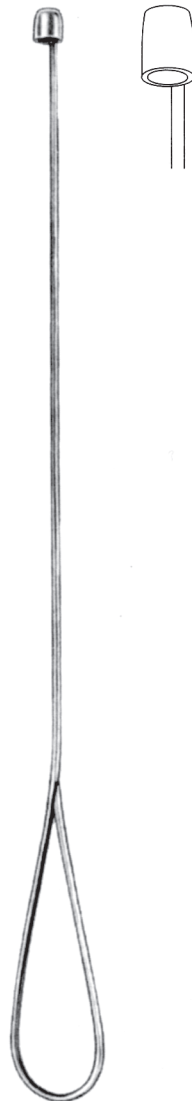

G28.1120.28 28.5cm



FISCHER
G28.1124.31 31.0cm



G28

Bleihände, Instrumente für Finger-und Zehennägel DE

Lead Hands, Nail Instruments EN

Manoplas de plomo, Instrumentos para uñas ES

اليد الرصاصي آلات المسمار AR



IDEAL
G28.1130.10 handle only
G28.1130.00 set



G28.1130.01



G28.1130.02



G28.1130.03



G28.1134.01 adult
G28.1134.02 child

G28-056 G28.1134.02



DE Hohlmessselzangen

EN Bone Rongeur Forceps

ES Pinzas-gubias

AR الملقط قطع العظام



13.0cm



G28.1140.01



G28.1140.02



13.0cm



G28.1144.01



G28.1144.02



KLEINERT-KUTZ
14.0cm



G28.1150.01



G28.1150.02



STELLBRINK
17.0cm



G28.1154.01

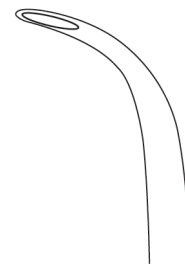

G28.1154.02

G28.1154.02 **G28-057**





MINI-FRIEDMAN
G28.1160.12 12.0cm



FRIEDMAN
G28.1160.14 14.0cm



MEAD
G28.1164.16 16.5cm



MEAD
G28.1166.16 16.5cm



HARTMANN
G28.1170.16 16.0cm

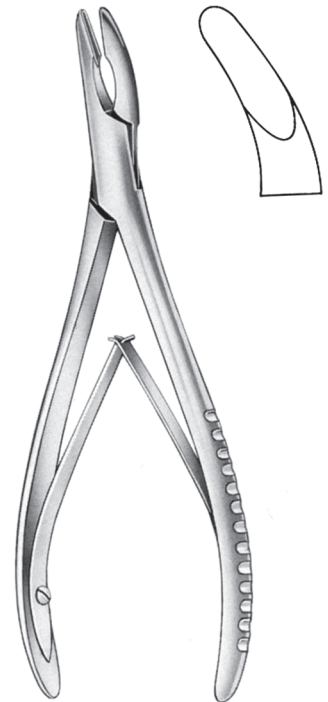

HARTMANN
G28.1170.18 18.5cm

G28-058 G28.1170.18



DE Hohlmessselzangen
EN Bone Rongeur Forceps
ES Pinzas-gubias
AR الملقط قطع العظام



JANSEN
18.0cm



G28.1174.01



G28.1174.02



G28.1174.03

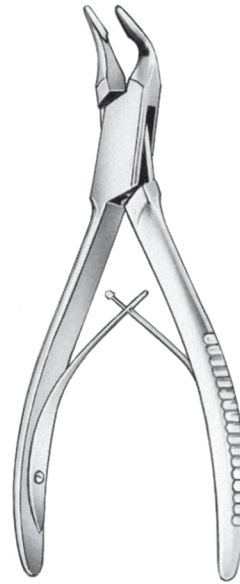

BLUMENTHAL
15.0cm



G28.1180.01



G28.1180.02



G28.1180.03

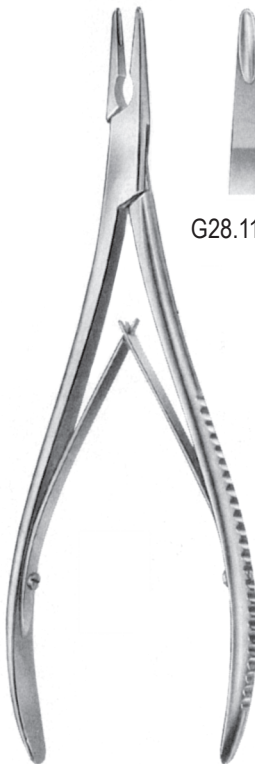

LEMPERT
20.0cm



G28.1184.20



G28.1185.20



DEFOURMENTEL
G28.1190.19 19.0cm



G28.1190.19 **G28-059**



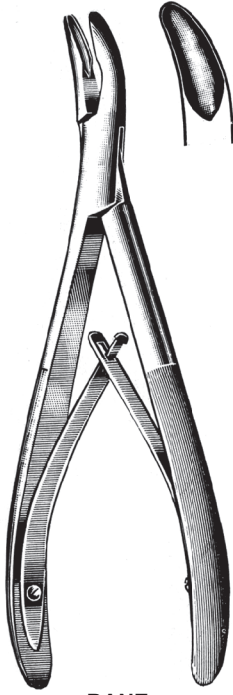

BANE
G28.1194.18 18.0cm

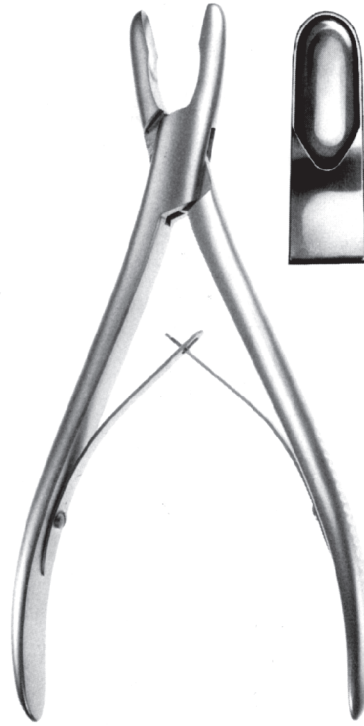

ADSON
G28.1200.21 21.0cm

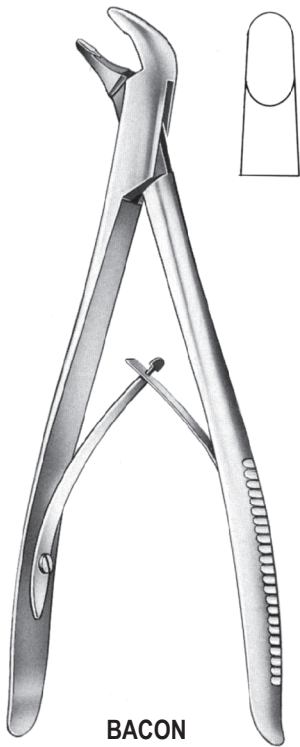

BACON
G28.1204.20 20.0cm



FISCH
17.0cm



G28.1210.01



G28.1210.02



DE Hohlmesselzangen

EN Bone Rongeur Forceps

ES Pinzas-gubias

AR الملقط قطع العظام



LUER
G28.1214.01 15.0cm



LUER
G28.1214.02 15.0cm



LUER
G28.1214.03 15.0cm



LUER
G28.1220.01 15.0cm



LUER
G28.1220.02 15.0cm

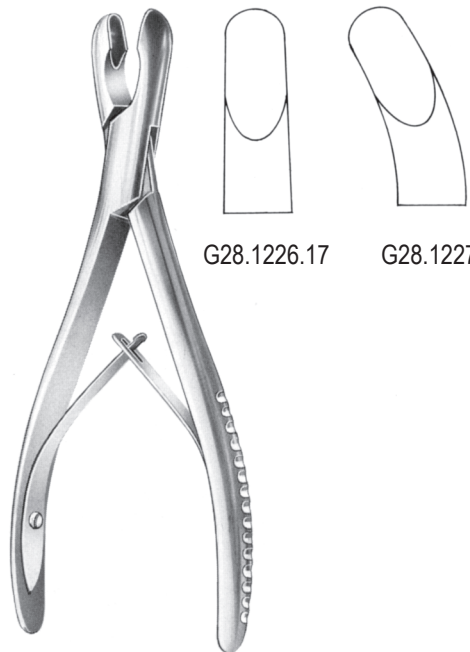

G28.1226.17

G28.1227.17

LUER
17.0cm

G28.1227.17 **G28-061**



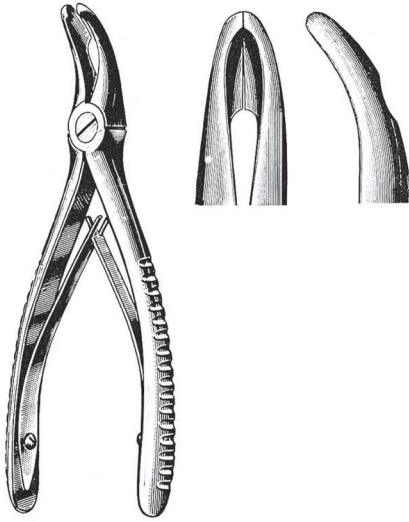

UNIVERSAL
G28.1230.13 13.5cm

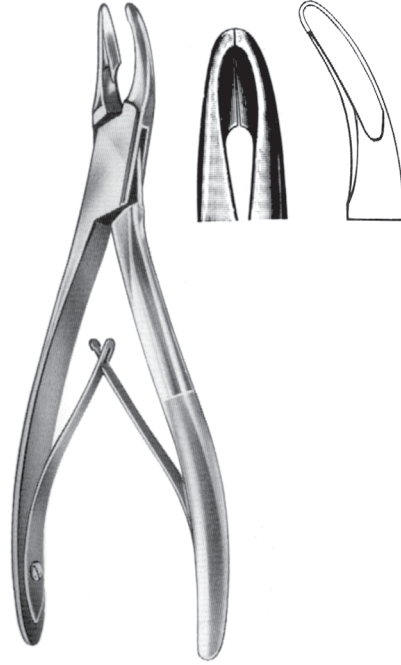

SHELL
G28.1234.17 17.0cm

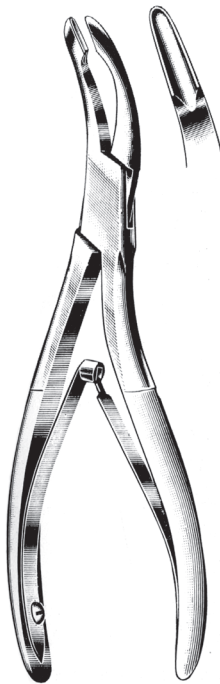

COTTLE-JANSEN
G28.1240.18 18.0cm

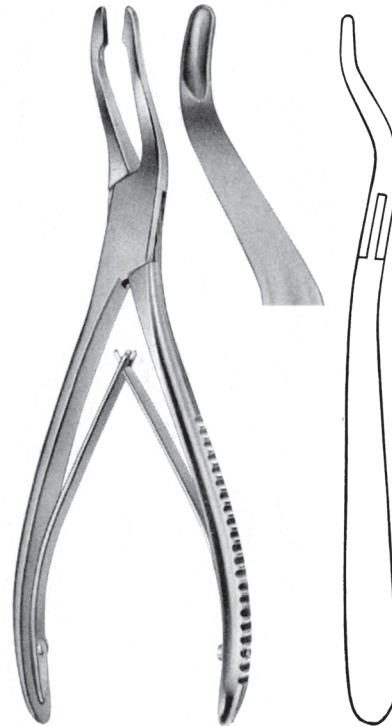

JANSEN
G28.1244.19 19.0cm

G28-062 G28.1244.19



DE Hohlmessselzangen

EN Bone Rongeur Forceps

ES Pinzas-gubias

AR الملقط قطع العظام

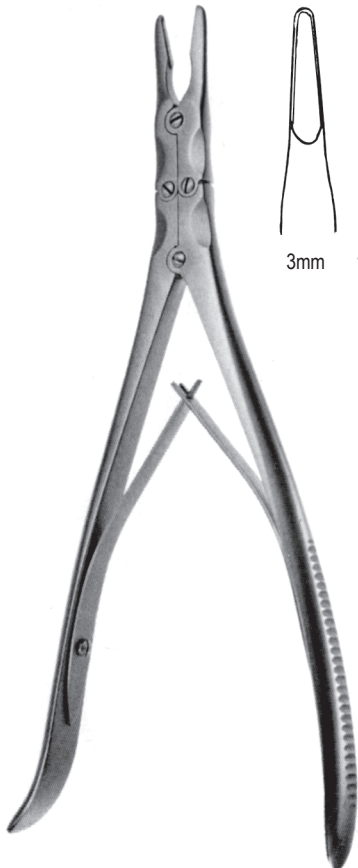

SMITH-PETERSEN
G28.1250.01 24.0cm

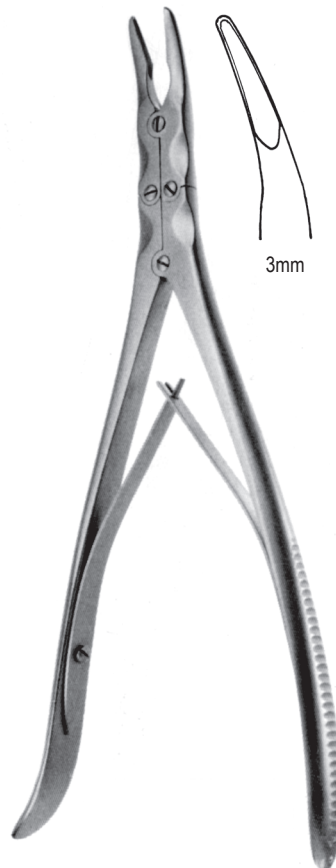

SMITH-PETERSEN
G28.1250.02 24.0cm



SMITH-PETERSEN
G28.1250.03 24.0cm

G28.1250.03 **G28-063**



G28

Hohlmessselzangen	DE
Bone Rongeur Forceps	EN
Pinzas-gubias	ES
الملقط قطع العظام	AR

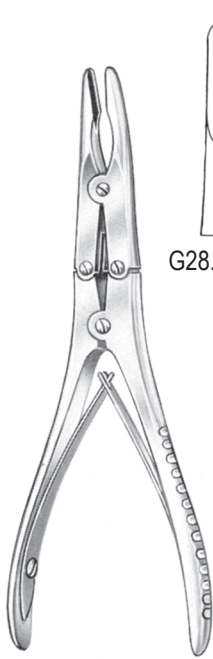

BÖHLER
15.5cm



G28.1254.15



G28.1255.15

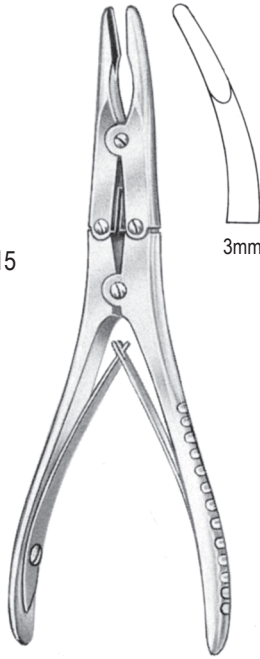

KLEINERT-KUTZ
G28.1260.15 15.0cm

3mm

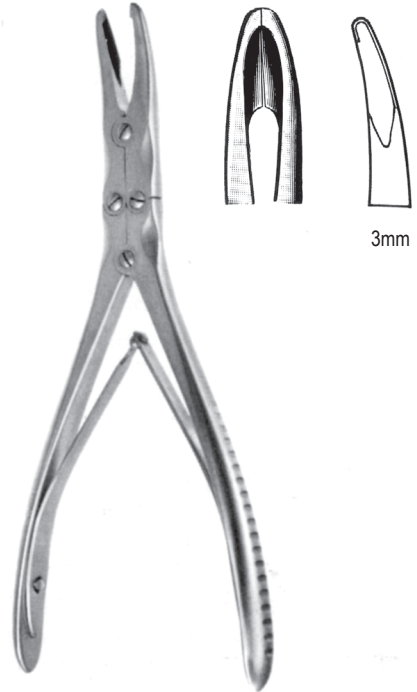

GEIGER
G28.1264.15 15.0cm

3mm

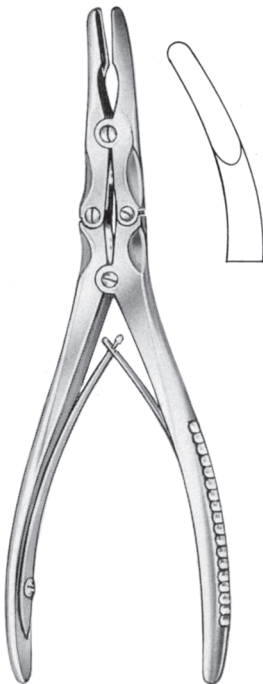

BEYER
G28.1270.18 18.0cm

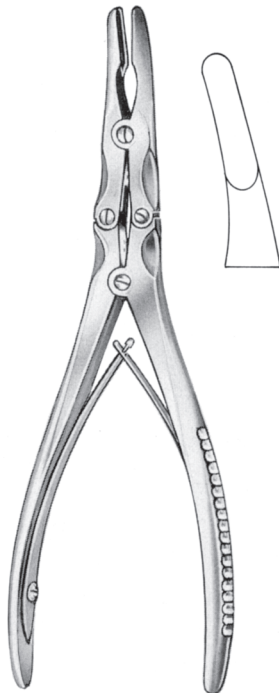

ZAUFAL-JANSEN
G28.1274.18 18.0cm

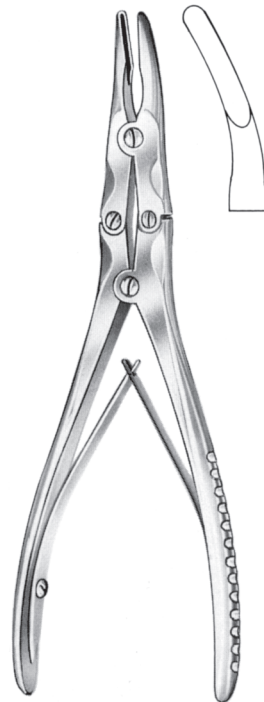

MAYFIELD
G28.1280.17 17.0cm

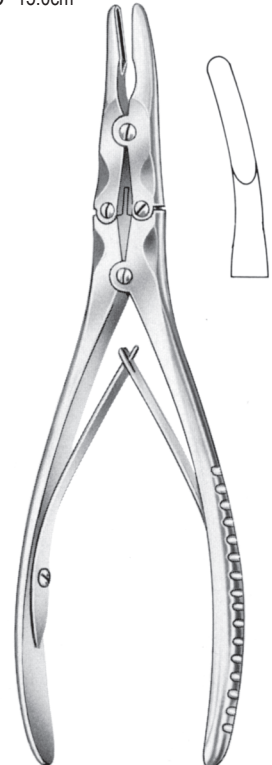

MARQUARDT
G28.1284.20 20.0cm

G28-064 G28.1284.20



DE Hohlmessselzangen
EN Bone Rongeur Forceps
ES Pinzas-gubias
AR الملقط قطع العظام



G28.1290.02
2mm



G28.1290.03
3mm



G28.1291.02
2mm

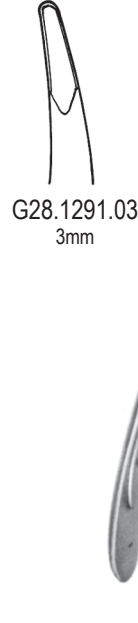

G28.1291.03
3mm



4mm



5mm



G28.1304.18



G28.1305.18



G28.1310.23

G28.1311.23

G28.1311.23 **G28-065**





FRYKHOLM
G28.1316.24 24cm



ECHLIN
23.0cm

G28.1320.02

G28.1320.03

G28.1320.04



DE Hohlmessselzangen
EN Bone Rongeur Forceps
ES Pinzas-gubias
AR الملقط قطع العظام

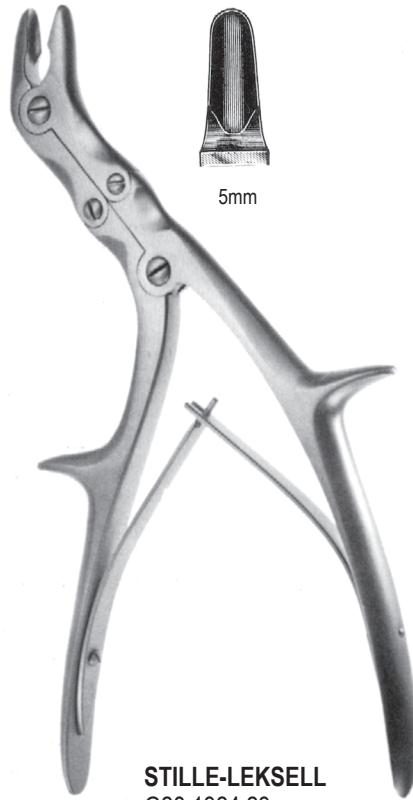

STILLE-LEKSELL
G28.1324.23 23.0cm



LEKSELL
23.0cm



LEKSELL-STILLE
24.0cm

G28.1334.02 **G28-067**





STILLE
G28.1340.23 23.0cm



STILLE-RUSKIN
G28.1344.23 23.0cm G28.1345.23



SEMB
G28.1350.22 22.5cm



DE Hohlmessselzangen
EN Bone Rongeur Forceps
ES Pinzas-gubias
AR الملقط قطع العظام



STILLE-LUER

G28.1354.22 22.0cm G28.1355.22



STILLE-LUER

G28.1360.23 23.0cm G28.1361.23
G28.1360.27 27.0cm G28.1361.27

G28.1361.27 **G28-069**



G28

Hohlmessselzangen DE
Bone Rongeur Forceps EN
Pinzas-gubias ES
الملقط قطع العظام AR



SAUERBRUCH
30.0cm

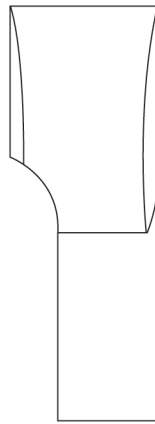

G28.1364.01

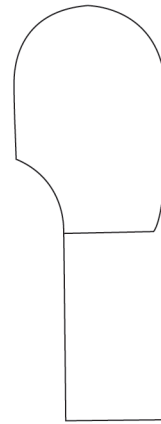

G28.1364.02

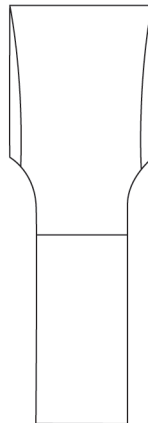

G28.1366.01

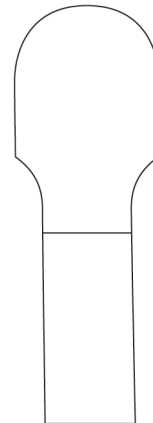

G28.1366.02

G28-070 G28.1366.02



DE Knochensplitterzangen

EN Bone Cutting Forceps

ES Pinzas cortantes para huesos

AR الملقط قطع العظام

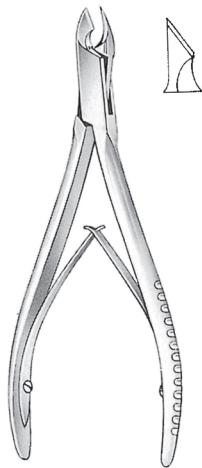

G28.1370.12 12.0cm

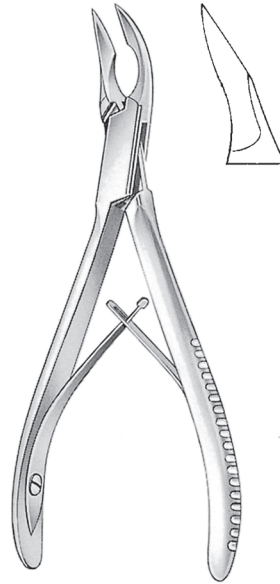

CLEVELAND
G28.1374.15 15.0cm

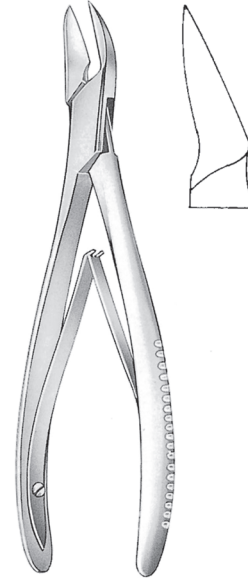

CLEVELAND
G28.1376.17 17.0cm

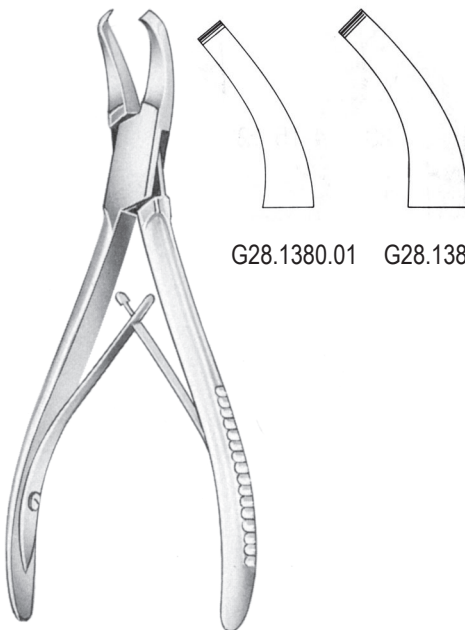

G28.1380.01 G28.1380.02

CLEVELAND
16.0cm

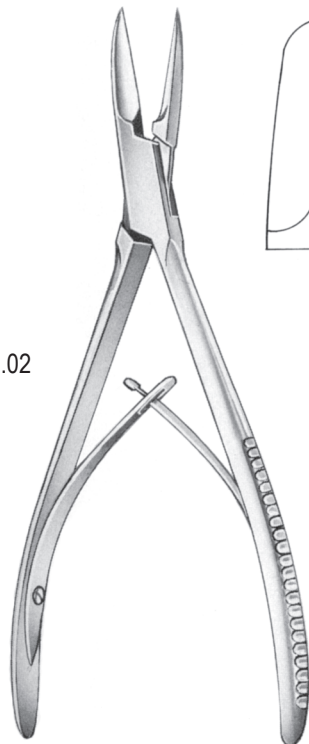

COTTLE-KAZANJIAN
G28.1384.19 19.0cm



MARKWALDER
G28.1390.20 20.0cm

G28.1390.20 **G28-071**



G28

Knochensplitterzangen DE

Bone Cutting Forceps EN

Pinzas cortantes para huesos ES

الملقط قطع العظام AR

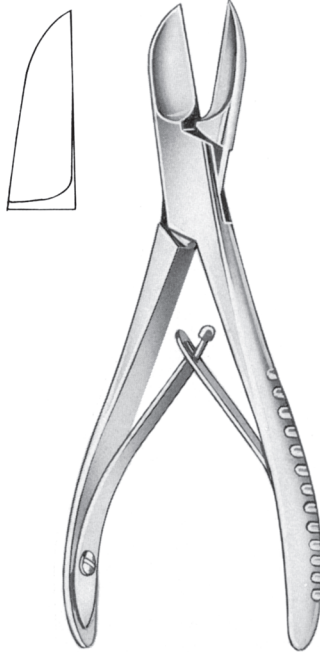

LISTON

G28.1400.14	14.0cm	G28.1401.14
G28.1400.17	17.0cm	G28.1401.17
G28.1400.19	19.0cm	G28.1401.19
G28.1400.22	22.0cm	G28.1401.22

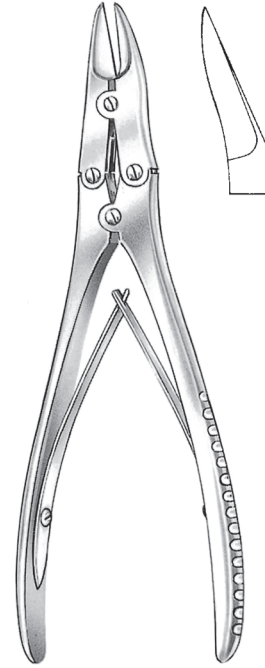

MC INDOE

G28.1406.17 17.5cm

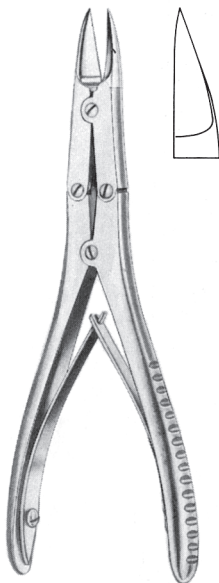

G28.1410.15 15.0cm



G28.1414.15

G28.1415.15

15.0cm

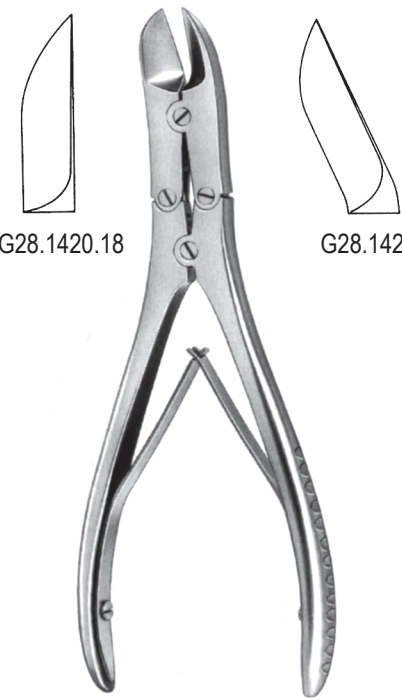

G28.1420.18

G28.1421.18

RUSKIN-LISTON

18.5cm

G28-072 G28.1421.18



DE Knochensplitterzangen

EN Bone Cutting Forceps

ES Pinzas cortantes para huesos

AR الملقط قطع العظام

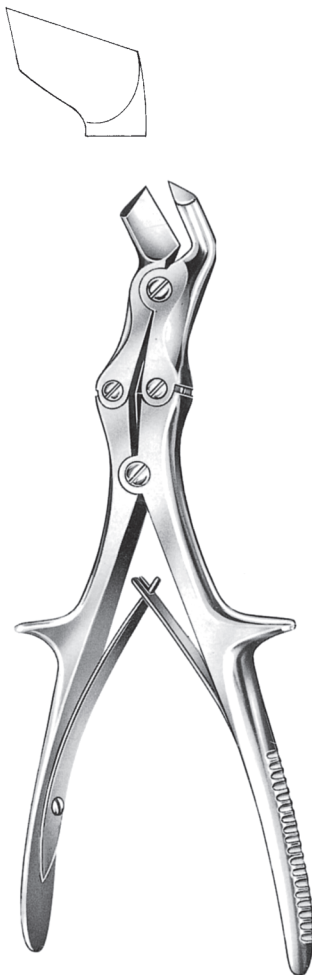

TUDOR-EDWARDS
G28.1426.23 23.0cm



SEMB
G28.1430.24 24.0cm



STILLE-LISTON
G28.1434.27 27.0cm



G28

Knochensplitterzangen DE

Bone Cutting Forceps EN

Pinzas cortantes para huesos ES

الملقط قطع العظام AR

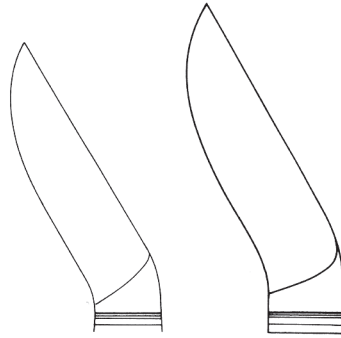

G28.1441.23

G28.1441.27

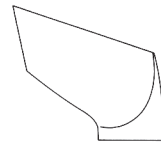

STILLE LISTON
G28.1440.27 27.0cm



STILLE LISTON
G28.1441.23 23.0cm
G28.1441.27 27.0cm



LISTON KEY
G28.1446.27 27.0cm

G28-074 G28.1446.27



DE Instrumente für Finger-und Zehennägel, Fingerringsägen

EN Nail Instruments, Finger Ring Saws

ES Instrumentos para uñas, Sierras para abrir anillos

AR آلات المسامير مناشير إصبع الخاتم

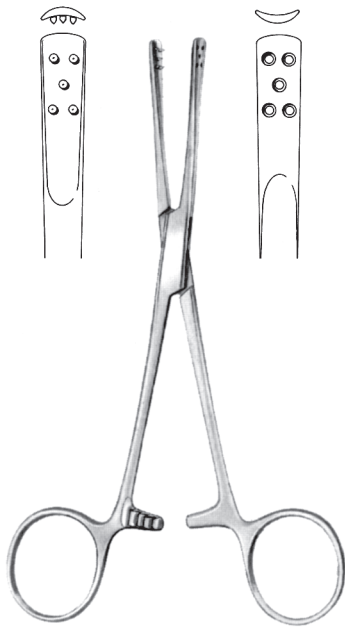

PENNER
G28.1450.15 15.5cm

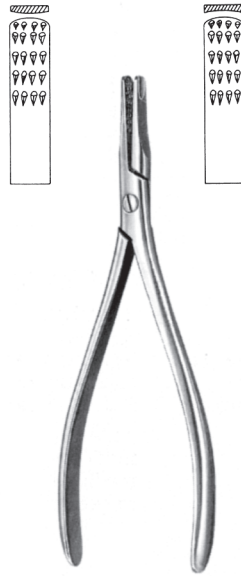

RADOLF
G28.1454.13 13.5cm



G28.1470.01 saw
G28.1470.02 key

G28.1470.00 17.0cm



G28.1472.01 saw
G28.1472.02 key

G28.1472.00 17.0cm



G28.1474.01 saw
G28.1474.02 key

WALTON
G28.1474.00 16.0cm

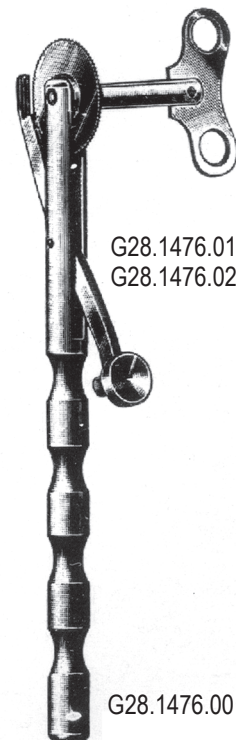

G28.1476.01 saw
G28.1476.02 key

G28.1476.00



G28

Knochenlöffel DE

Bone Spoon EN

Cucharilla cortantes ES

ملعقة العظام AR



G28.1480.26 26.5cm



G28.1482.27 27.0cm



G28.1484.28 28.0cm



G28.1486.28 28.0cm

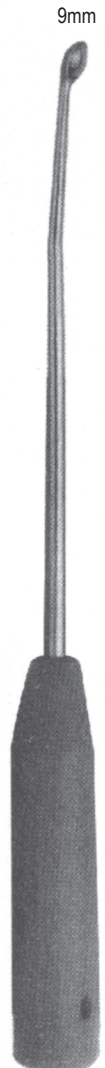

G28.1488.00



G28-076 G28.1488.00