

- **Medical Equipment**
- **Surgical instruments**

Kochenchirurgie

DE	Kochenchirurgie
EN	Bone Surgery
ES	Cirugia ósea
AR	جراحة العظام

G26

PAGE 001 to 020



DE **Amputations-und-Resektionssagen**
EN **Amputating and Resection Saws**
ES **Sierras para amputacion y reseccion**
AR **مناشير البتر**

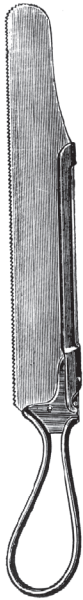

CHARRIERE

G26.0010.27 27.0cm
G26.0010.30 30.0cm
G26.0010.34 34.0cm



SATTERLEE

G26.0014.31 31.0cm



CHARRIERE

G26.0020.27 27.0cm
G26.0020.30 30.0cm



SATTERLEE

G26.0024.31
31.0cm

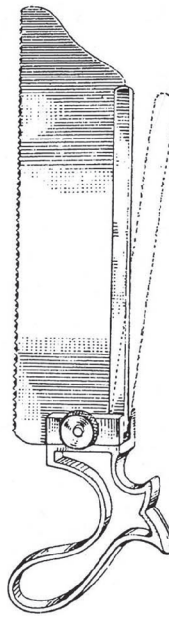

G26.0030.23
23.0cm

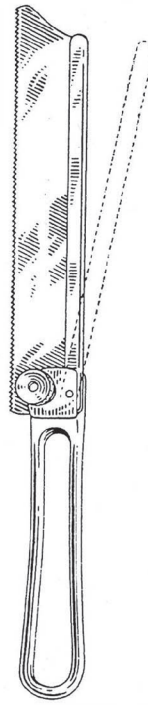

G26.0034.19
19.0cm

G26.0034.19 **G26-001**



G26

Amputations-und-Resektionssagen DE
Amputating and Resection Saws EN
Sierras para amputacion y reseccion ES
AR

SPARE SAW BLADE
G26.0040.12 12mm
G26.0040.15 15mm
G26.0040.18 18mm



CHAARRIERE
G26.0040.35 35.0cm

SPARE SAW BLADE
G26.0044.03 3mm
G26.0044.05 5mm
G26.0044.07 7mm



HELPERICH-BIER
G26.0044.39 39.0cm

LINDEMANN
G26.0050.20 20.0cm



LANGENBECK
G26.0054.23 23.0cm



G26.0060.06 6mm
G26.0060.08 8mm
G26.0060.12 12mm
G26.0060.15 15mm
G26.0060.18 18mm

RUST
G26.0060.39 39.0cm



G26-002 G26.0060.39



DE Handbohrapparate

EN Hand Drills

ES Perforadores de mano para huesos

AR مثقاب يدوي



STILLE-SHERMAN

24.0cm

G26.0070.00 compl. set

G26.0070.24 drill only



G26.0072.25
2.5mm Ø

G26.0072.30
3.0mm Ø

G26.0072.35
3.5mm Ø



HUDSON

G26.0074.00 compl. set / 6
(26.0074.27,01,
02,03,07,09)

G26.0074.27 handle only



G26.0076.01
9mm Ø



G26.0076.02
14mm Ø



G26.0076.03
16mm Ø



G26.0076.04
22mm Ø



CUSHING
G26.0076.05
14mm Ø



G26.0076.06
2mm Ø



MCKENZIE
G26.0076.07
13mm Ø



ERRICO
G26.0076.08
16mm Ø



G26.0076.09

G26.0076.09 **G26-003**



G26

Handbohrapparate DE

Hand Drills EN

Perforadores de mano para huesos ES

مثقاب يدوي AR



STILLE

20.0cm

G26.0080.00 compl. set
G26.0080.20 drill only



G26.0082.01
2.5mm Ø

G26.0082.02
3.0mm Ø

G26.0082.03
3.5mm Ø

G26.0082.04
4.0mm Ø

G26.0082.05
10.0mm Ø

G26.0082.06
5.0mm Ø

G26.0082.07
8.0mm Ø

G26.0082.08
12.0mm Ø

G26.0082.09
16.0mm Ø

G26.0082.10
1.0mm Ø

G26.0082.11
1.5mm Ø

G26.0082.12
2.0mm Ø



G26.0084.00 compl. set
G26.0084.01 drill only



G26.0084.09
9.0cm
3.2mm Ø

G26.0084.07
7.0cm
3.2mm Ø

26.0084.08
Set of drills



JACOBS

G26.0090.00 6.35mm

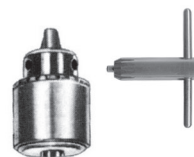

G26.0092.00 set

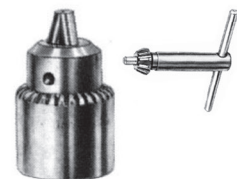

G26.0094.00 set

G26-004 G26.0094.00



DE Handbohrapparate

EN Hand Drills

ES Perforadores de mano

AR مثقاب يدوي

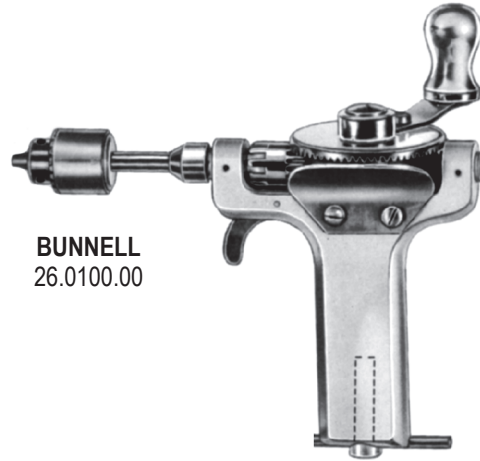

BUNNELL
26.0100.00



RALK
26.0104.00

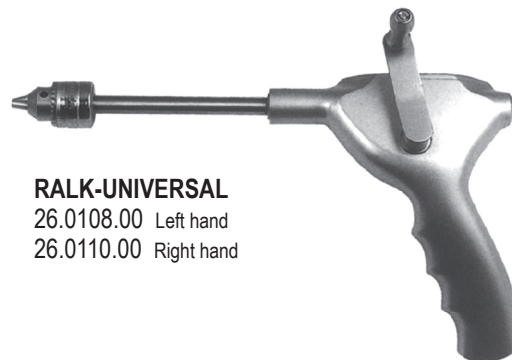

RALK-UNIVERSAL
26.0108.00 Left hand
26.0110.00 Right hand

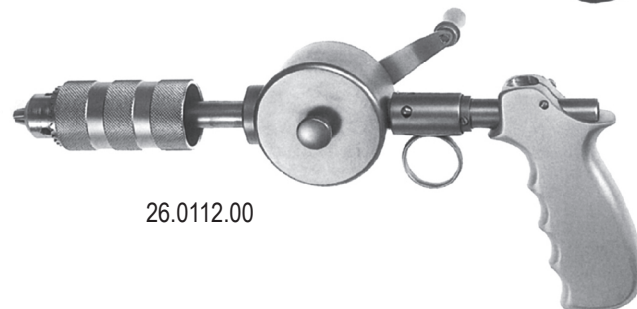

26.0112.00



G26

Handbohrapparate DE

Hand Drills EN

Perforadores de mano para huesos ES

مثقاب يدوي AR

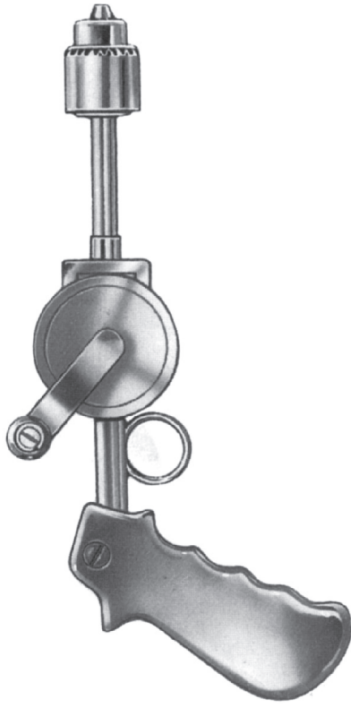

G26.0116.00



G26.0120.00



G26.0122.00

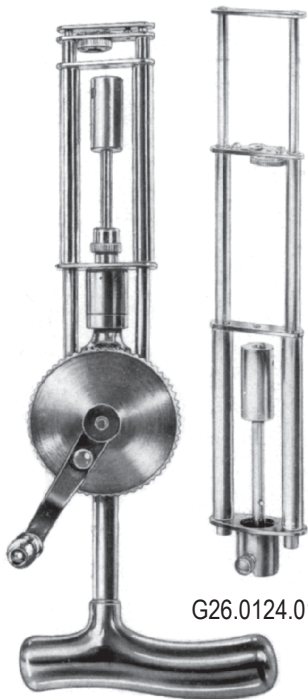

G26.0124.01

G26.0124.00 complete set



G26.0128.01

G26.0128.02

G26.0128.03

KIRSCHNER
G26.0128.00 complete set

G26-006 G26.0128.03



- DE Knochentplatten-Biegehebel-schrauben und platten Haltezangen
EN Hand Bone Plate Wrench and Screw and Plate Holding Forceps
ES Elevador p/pleger las placas y pinzas porta-tornillos placas
AR عظم اللوحة وجع والملقط المسامرواللوحة القابضة

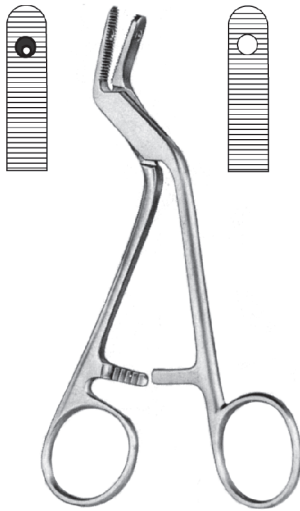

ADSON
G26.0130.15
15.0cm

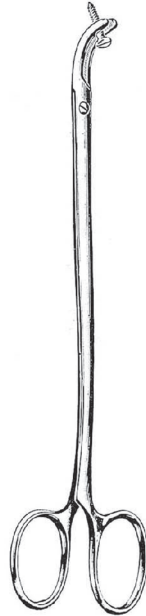

ADSON
G26.0134.18
18.0cm



LANE
G26.0140.22
22.0cm

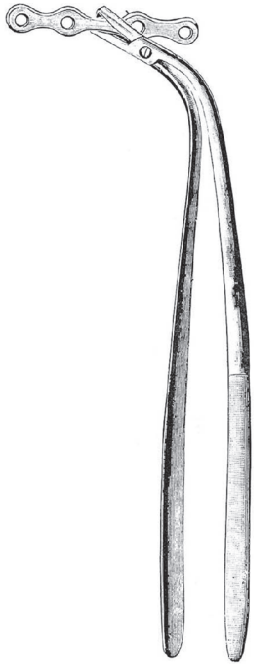

LANE
G26.0144.22
22.0cm



LANE
G26.0150.18
18.0cm



G26.0154.25
25.5cm



G26

Schraubenzieher DE

Screw Drivers EN

Destornilladores ES

المفكات AR

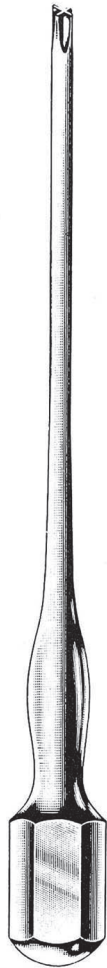

G26.0160.25 25.0cm

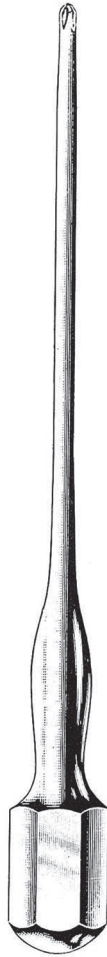

PHILLIPS
G26.0164.25 25.0cm



LANE
G26.0170.17 17.0cm
G26.0170.25 25.0cm

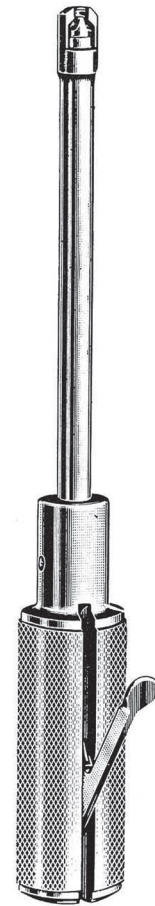

WILLIAMS
G26.0174.24 24.0cm



G26-008 G26.0174.24

DE Schraubenzieher
EN Screw Drivers
ES Destornilladores
AR المفكات



G26.0180.25 2.5mm
G26.0180.35 3.5mm
G26.0180.45 4.5mm
25.0cm

PHILLIPS
G26.0184.25 25.0cm

G26.0190.25 25.0cm

LANE
G26.0194.17 17.0cm
G26.0194.25 25.0cm

G26.0194.25 **G26-009**



G26

Schraubenzicher-set mit-Etui DE

Screw Driver set in case EN

Juego de destornilladores en esuche ES

طقم المفكات AR



1/2
G26.0200.14 14.5cm



1/4
G26.0200.13

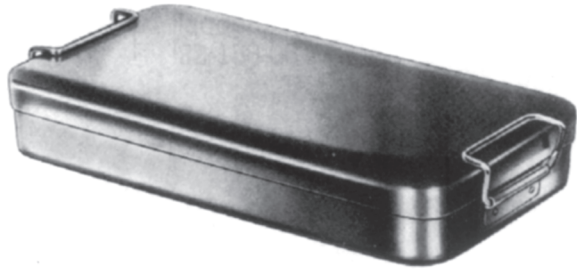

G26.0200.00 Screw driver set, complete in case
G26.0200.01 Sterilizing case only



1/4
G26.0200.02



1/4
G26.0200.03



1/4
G26.0200.04



1/4
G26.0200.05



1/4
G26.0200.06
G26.0200.07

G26-010 G26.0200.07

DE Nageln Sie Fahrer und Reibahlen
 EN Nail Driver and Reamers
 ES Clave a conductores y escariadores
 AR مسمار السائق وموسعات ثقوب



G26.0210.24
2.4mm



G26.0210.32
3.2mm



G26.0210.48
4.8mm



G26.0210.64
6.4mm

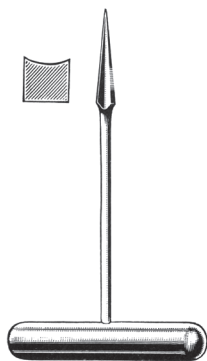

G26.0220.14 14.0cm



G26.0222.14 14.0cm



PERTHES
G26.0224.21 21.0mm

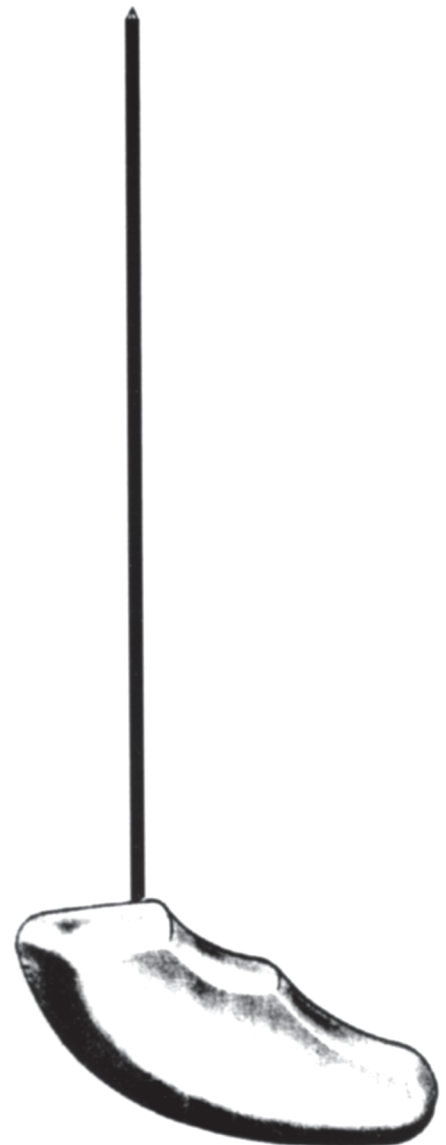

G26.0226.24 2.4mm
 G26.0226.32 3.2mm
 G26.0226.48 4.8mm
 G26.0226.64 6.4mm

G26.0226.64 **G26-011**



Flachzangen, Draht-kheifzangen, Faßzangen DE

Flat Nose Pliers, Wire Cutting Pliers, Seizing Forceps EN

Alicates planos, alicates para cortar alambre, pinzas para coger ES

كماشة الأنف مسطح، كماشة قطع الأسلاك، الملقط الاستيلاء على AR

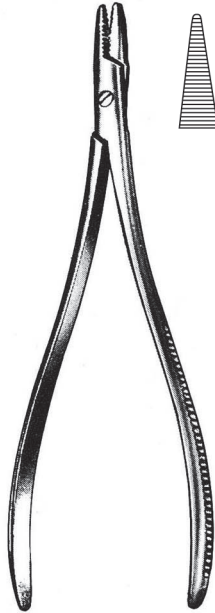

G26.0230.16 16.5cm

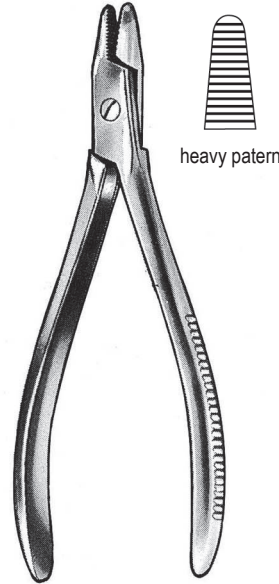

G26.0232.16 16.0cm



G26.0236.15 15.0cm



G26.0240.17 17.0cm



G26.0242.18 18.0cm



G26.0244.18 18.0cm



DE Flachzangen
EN Flat Nose Pliers
ES Alicates planos
AR كماشة الأنف مسطح



17.0cm



G26.0250.01



G26.0250.02



18.0cm



G26.0254.01



G26.0254.02



G26.0254.03

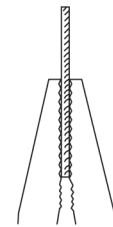

parallel action

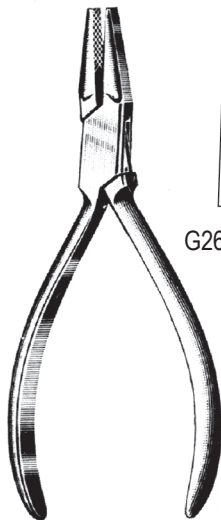

14.0cm



G26.0258.01



G26.0258.02



G26.0262.16 16.0cm

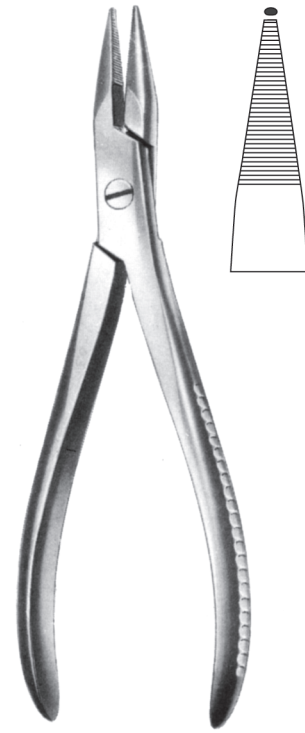
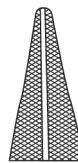

G26.0266.19 19.5cm

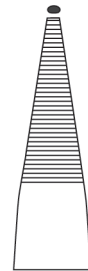

Vorschlaginstrument-Nagelzieher, drahtspanninstrumente und Zubehör DE

Impactor/Extractor, Wire Tighteners and Accessories EN

Conductor-extractor, tensores cierra-hilo y accesorios ES

المسبار/النازع، سلك مشدد وإكسسوارات AR



PARHAM

- G26.0270.18 18.0cm
- G26.0270.20 20.0cm
- G26.0270.25 25.0cm
- G26.0270.30 30.0cm



PARHAM

G26.0274.22 22.0cm



DEMEL

G26.0280.28 28.0cm

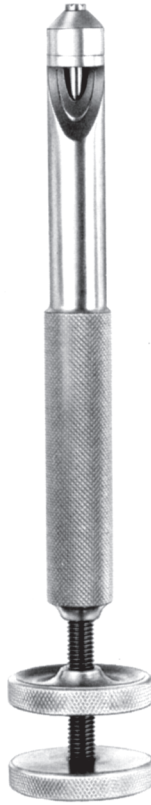
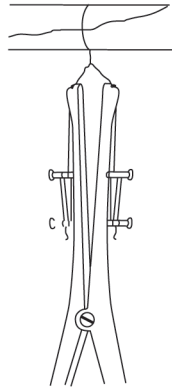

LOUTE

G26.0284.21 21.0cm

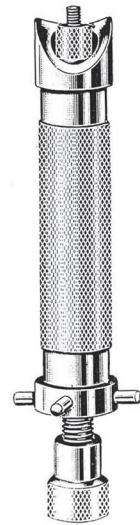

LLOYD

G26.0288.00

G26-014 G26.0288.00



DE Cerclage-Draht, Drahtumfuhrungsnadeln

EN Bone Wire, Bone Wire Guides

ES Hilo para huesos, agujas pasa-hilos

AR سلك العظام، توجيهه سلك العظام



	soft	hard
0.2mm Ø	G26.0290.02	
0.3mm Ø	G26.0290.03	G26.0292.03
0.4mm Ø	G26.0290.04	G26.0292.04
0.5mm Ø	G26.0290.05	
0.6mm Ø	G26.0290.06	G26.0292.06
0.7mm Ø	G26.0290.07	
0.8mm Ø	G26.0290.08	G26.0292.08
0.9mm Ø	G26.0290.09	
1.0mm Ø	G26.0290.10	G26.0292.10
1.2mm Ø	G26.0290.12	
1.5mm Ø	G26.0290.15	

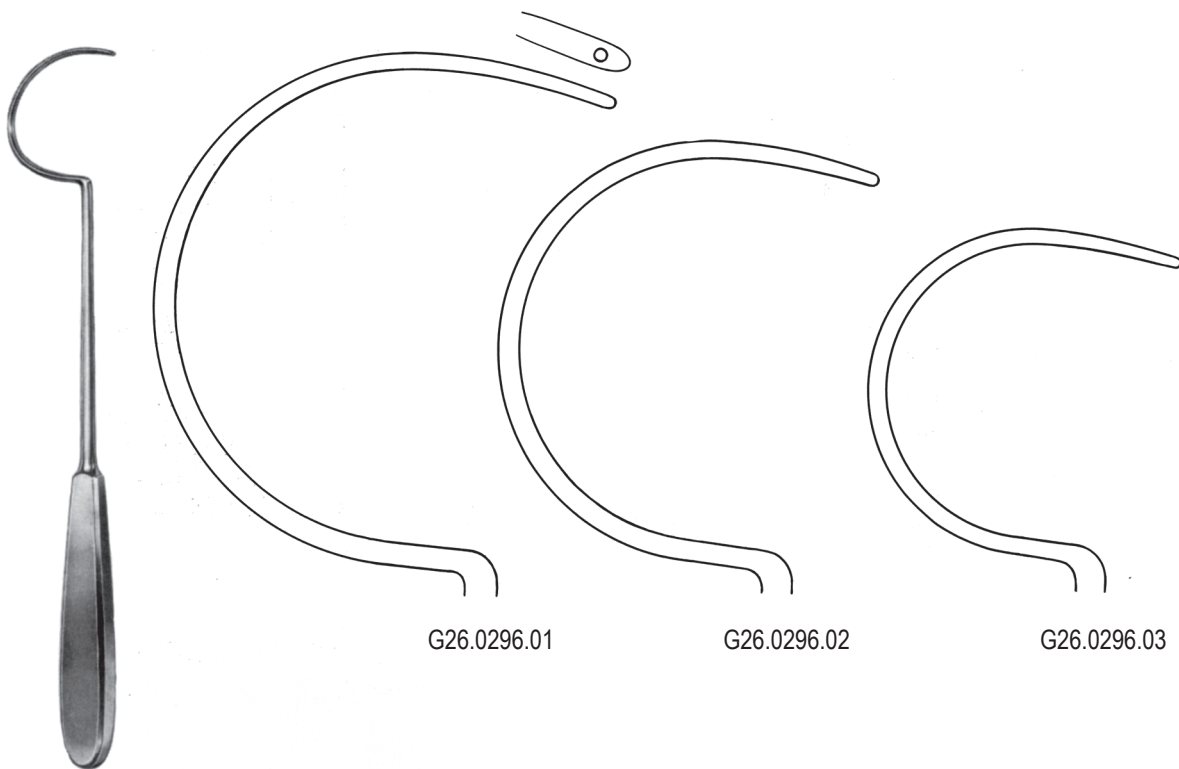

G26.0296.01

G26.0296.02

G26.0296.03

DEMEL





KUENTSCHER
G26.0304.21 21.0cm



KUENTSCHER
G26.0306.21 21.0cm



KUENTSCHER
G26.0310.00 63.0cm
complete set



G26.0310.01



G26.0310.02



G26.0310.03



G26.0310.04

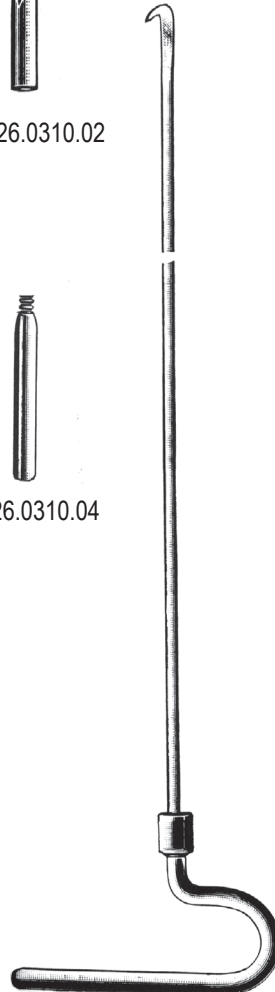

G26.0314.29 29.0cm
G26.0314.37 37.0cm
G26.0314.42 42.0cm
G26.0314.49 49.0cm

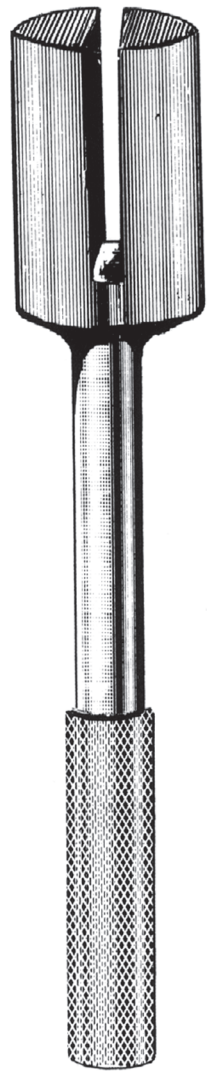

G26.0320.00



DE Knochennagelung, Steinmann Nagel
 EN Bone Nailing, Steinmann Pins
 ES Enclavamiento de huesos, calvos segun steinmann
 AR تسمير العظام، دبابيس ستينمان



	L=35cm	L=46cm	L=60cm
2.5mm Ø	G26.0330.25	G26.0332.25	
3.0mm Ø	G26.0330.30	G26.0332.30	
3.5mm Ø	G26.0330.35	G26.0332.35	G26.0334.35
4.0mm Ø	G26.0330.40	G26.0332.40	G26.0334.40
5.0mm Ø	G26.0330.50	G26.0332.50	G26.0334.50

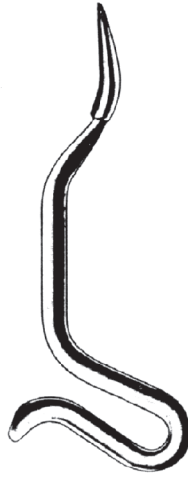

KUENTSCHER
G26.0340.26 26.0cm



KUENTSCHER
G26.0344.35 35.0cm



STEINMANN
4mm Ø (Trocar tip)
G26.0360.14 140mm
G26.0360.16 160mm
G26.0360.18 180mm
G26.0360.20 200mm



SCHANZ
4mm Ø (Flat tip)
G26.0364.06 60mm
G26.0364.08 80mm
G26.0364.10 100mm



SCHANZ
6mm Ø (Flat tip)
G26.0366.10 100mm
G26.0366.13 130mm
G26.0366.16 160mm
G26.0366.19 190mm



SCHANZ
5mm Ø (Trocar tip)
G26.0368.10 100mm
G26.0368.12 125mm
G26.0368.15 150mm
G26.0368.17 170mm
G26.0368.20 200mm
G26.0368.25 250mm

G26.0368.25 **G26-017**



KIRSCHNER
trocar point
flat end



mm ø	60 mm	120mm	140mm	160mm	310mm
0.6	G26.0380.06				
0.8	G26.0380.08				
1.0	G26.0380.10	G26.0382.10	G26.0384.10	G26.0386.10	G26.0388.10
1.2	G26.0380.12	G26.0382.12	G26.0384.12	G26.0386.12	G26.0388.12
1.4	G26.0380.14	G26.0382.14	G26.0384.14	G26.0386.14	G26.0388.14
1.5	G26.0380.15	G26.0382.15	G26.0384.15	G26.0386.15	G26.0388.15
1.6	G26.0380.16	G26.0382.16	G26.0384.16	G26.0386.16	G26.0388.16
1.8	G26.0380.18	G26.0382.18	G26.0384.18	G26.0386.18	G26.0388.18
2.0	G26.0380.20	G26.0382.20	G26.0384.20	G26.0386.20	G26.0388.20
2.2	G26.0380.22	G26.0382.22	G26.0384.22	G26.0386.22	G26.0388.22
2.5	G26.0380.25	G26.0382.25	G26.0384.25	G26.0386.25	G26.0388.25

KIRSCHNER
trocar point
round end



mm ø	60 mm	120mm	140mm	160mm	310mm
1.0	G26.0390.10	G26.0392.10	G26.0394.10	G26.0396.10	G26.0398.10
1.2	G26.0390.12	G26.0392.12	G26.0394.12	G26.0396.12	G26.0398.12
1.4	G26.0390.14	G26.0392.14	G26.0394.14	G26.0396.14	G26.0398.14
1.5	G26.0390.15	G26.0392.15	G26.0394.15	G26.0396.15	G26.0398.15
1.6	G26.0390.16	G26.0392.16	G26.0394.16	G26.0396.16	G26.0398.16
1.8	G26.0390.18	G26.0392.18	G26.0394.18	G26.0396.18	G26.0398.18
2.0	G26.0390.20	G26.0392.20	G26.0394.20	G26.0396.20	G26.0398.20
2.2	G26.0390.22	G26.0392.22	G26.0394.22	G26.0396.22	G26.0398.22
2.5	G26.0390.25	G26.0392.25	G26.0394.25	G26.0396.25	G26.0398.25

KIRSCHNER
lancet point
flat end



mm ø	100 mm
1.0	G26.0400.10
1.2	G26.0400.12
1.5	G26.0400.15
1.6	G26.0400.16
1.8	G26.0400.18
2.0	G26.0400.20
2.2	G26.0400.22
2.5	G26.0400.25



DE **Extensionsbugel und Zubehor**
 EN **Extension Bows and Accessories**
 ES **Estribos para extension y accesorios**
 AR **امتداد الانحناء وإكسسوارات**

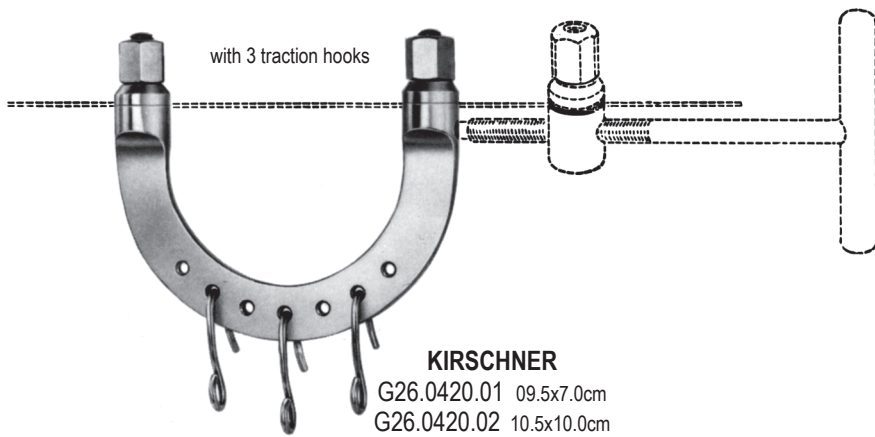

KIRSCHNER

- G26.0420.01 09.5x7.0cm
- G26.0420.02 10.5x10.0cm
- G26.0420.03 12.0x12.0cm
- G26.0420.04 15.5x15.5cm
- G26.0420.05 20.0x15.5cm



KIRSCHNER

- G26.0424.01 6.0x6.0cm

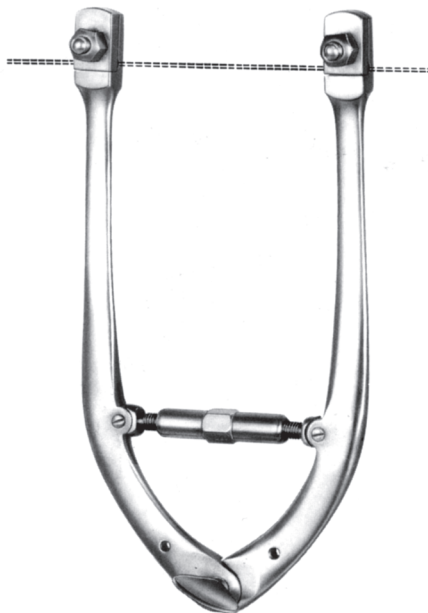

- G26.0430.18 18.0x10.0cm
- G26.0430.27 27.0x27.0cm

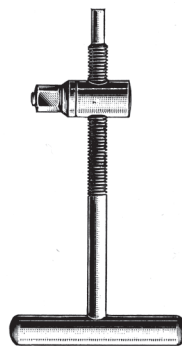

- G26.0434.18



- G26.0440.19 19.0cm



- G26.0444.03
- G26.0444.06



Extensionsbugel und Draht-Kneifzangen DE

Extension Bows and Wire Cutting Pliers EN

Estribos para extension y alicates para cortar alambre ES

امتداد الانحناء و كماشة قطع الأسلاك AR

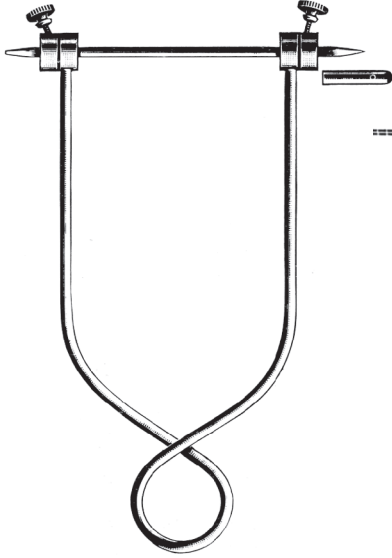

BÖHLER

G26.0450.15 21.0x15.0cm
G26.0450.16 16.0x9.0cm
G26.0450.21 21.0x11.0cm



KIRSCHNER

G26.0454.01 13.5cm, infant
G26.0454.02 18.5cm, child
G26.0454.03 27.0cm, adult



MARTIN-DIAMANT

G26.0460.16
16.0cm



G26.0464.16
16.0cm



G26.0470.15
15.0cm



G26.0474.23
23.0cm



G26.0474.25
25.0cm



G26.0480.24
24.0cm

G26-020 G26.0480.24

