

- **Medical Equipment**
- **Surgical instruments**

## Arterienklemmen

DE	Arterienklemmen
EN	Artery Forceps
ES	Pinzas hemostáticas
AR	الملقط الشريان

**G14**

PAGE 001 to 042



# G14

DE Bulldogklemmen, Alegepinzetten  
 EN Bulldog Clamps, Setting Forceps  
 ES Clamps bulldog, pinzas para poner  
 AR المشابك بلدغ، وضع الملقط

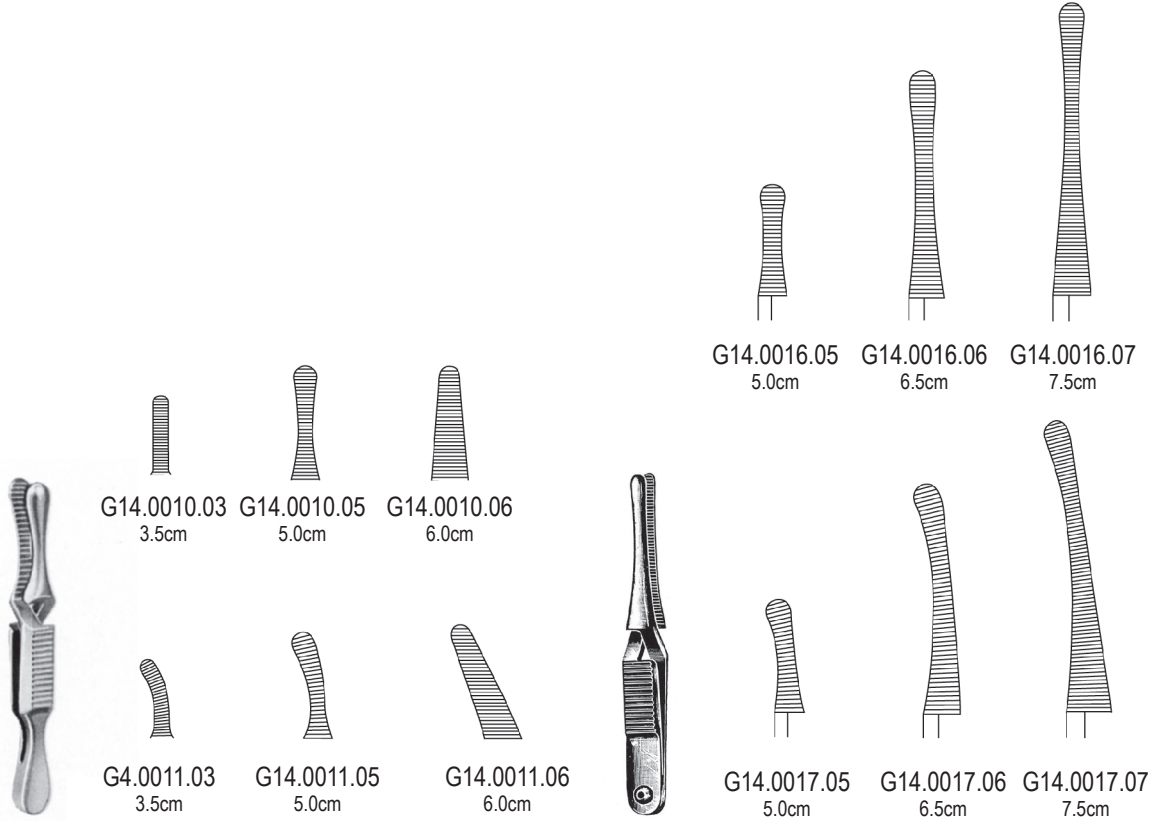

**DIEFFENBACH**

**JOHNS-HOPKINS**

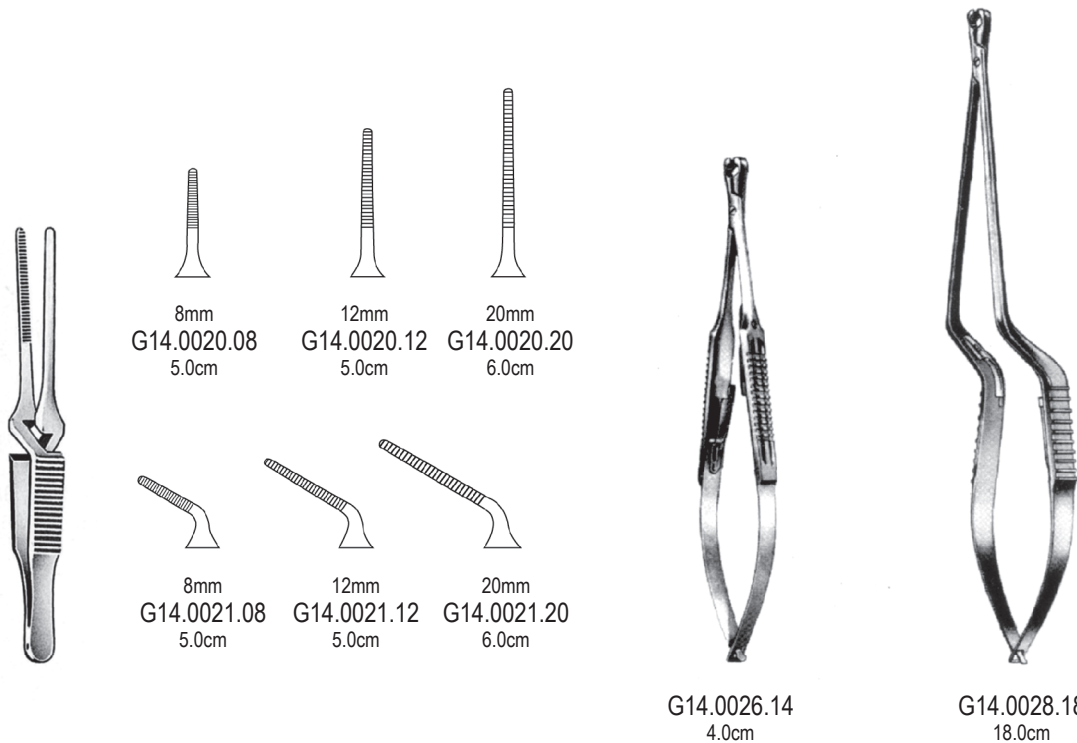

G14.0028.18 **G14-001**



# G14

Arterienklemmen DE

Artery Forceps EN

Pinzas hemostaticas ES

الملقط الشريان AR



**HARTMANN**  
G14.0030.10 10.0cm G14.0031.10

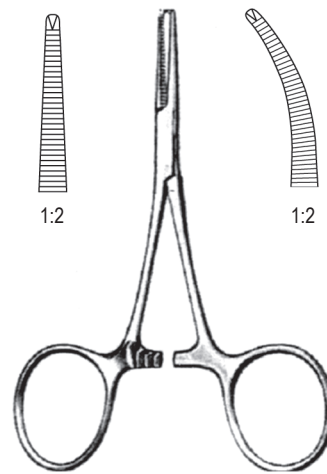

**HARTMANN**  
G14.0032.10 10.0cm G14.0033.10



**CARREL**  
G14.0040.08 8.5cm

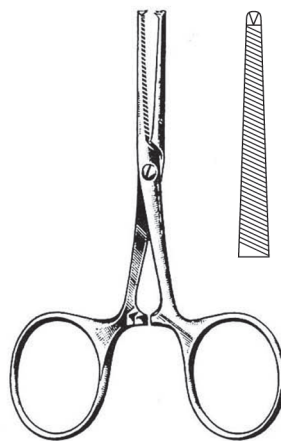

**TERRIER**  
G14.0044.08 8.5cm

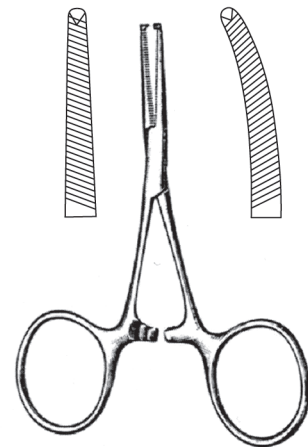

**TERRIER**  
G14.0048.09 9.0cm G14.0049.09

**G14-002** G14.0049.09



DE Arterienklemmen  
EN Artery Forceps  
ES Pinzas hemostaticas  
AR الملقط الشريان

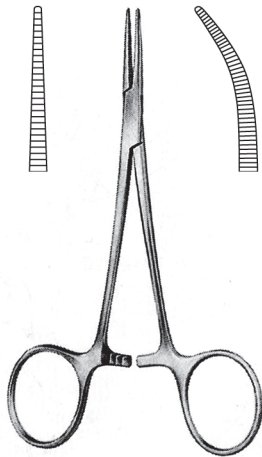

**HALSTED-MOSQUITO**

G14.0060.12 12.5cm G14.0061.12  
G14.0060.14 14.0cm G14.0061.14

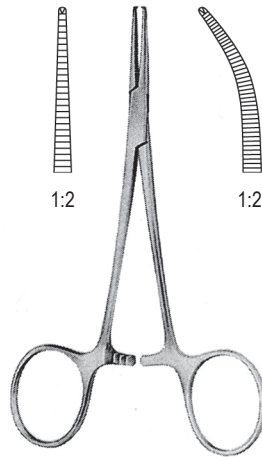

**HALSTED-MOSQUITO**

G14.0062.12 12.5cm G14.0063.12  
G14.0062.14 14.0cm G14.0063.14

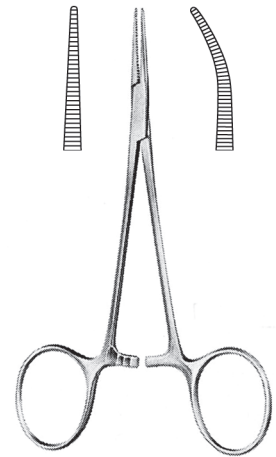

**MICRO-MOSQUITO**

14.0070.10 10.0cm G14.0071.10  
G14.0070.12 12.0cm G14.0071.12  
G14.0070.14 14.0cm G14.0071.14

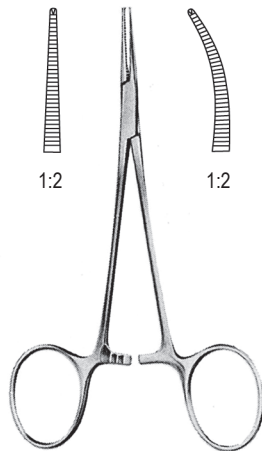

**MICRO-MOSQUITO**

G14.0072.10 10.0cm G14.0073.10  
G14.0072.12 12.0cm G14.0073.12  
G14.0072.14 14.0cm G14.0073.14

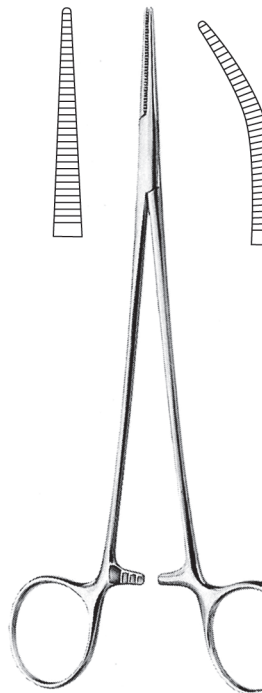

**HALSTED-MOSQUITO**

G14.0080.16 16.0cm G14.0081.16  
G14.0080.18 18.0cm G14.0081.18  
G14.0080.21 21.0cm G14.0081.21

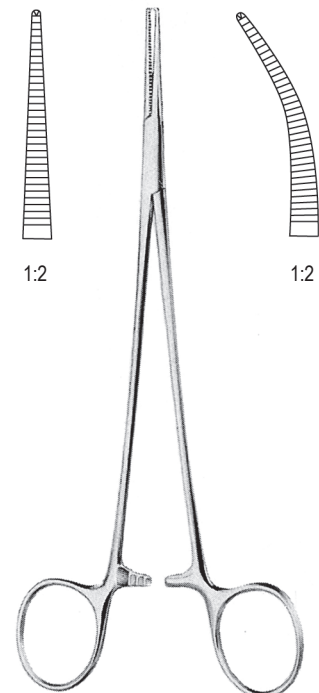

**HALSTED-MOSQUITO**

G14.0082.16 16.0cm G14.0083.16  
G14.0082.18 18.0cm G14.0083.18  
G14.0082.21 21.0cm G14.0083.21

G14.0083.21 **G14-003**



# G14

Arterienklemmen DE

Artery Forceps EN

Pinzas hemostaticas ES

الملقط الشريان AR

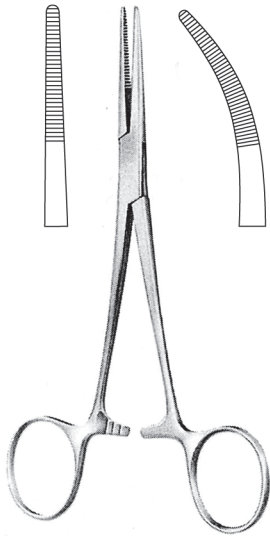

**KELLY**

G14.0090.14 14.0cm G14.0091.14

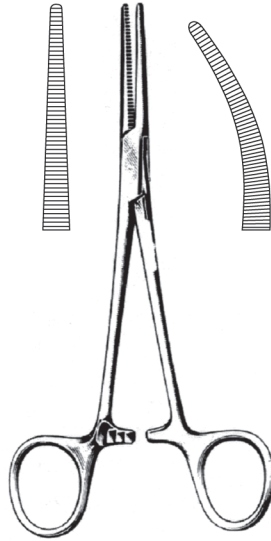

**CRILE**

G14.0094.14 14.0cm G14.0095.14

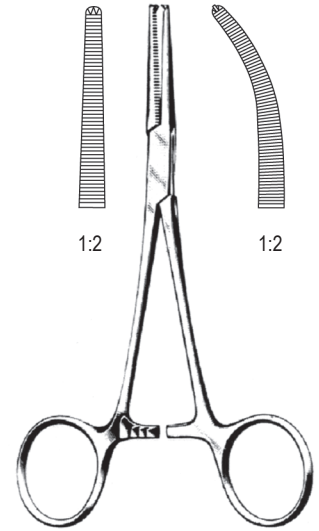

**CRILE**

G14.0096.14 14.0cm G14.0097.14

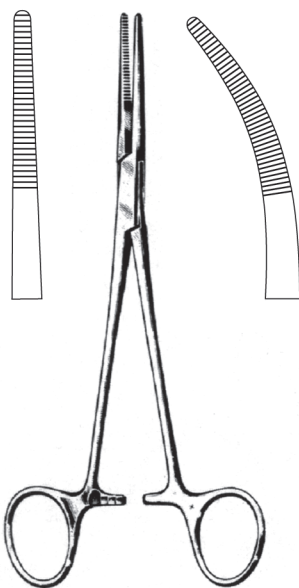

**RANKIN-KELLY**

G14.0100.16 16.0cm G14.0101.16

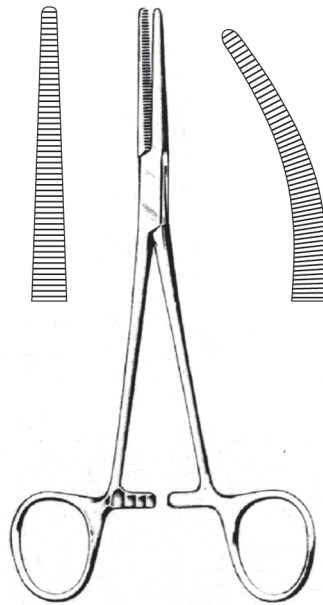

**RANKIN-CRILE**

G14.0104.16 16.0cm G14.0105.16

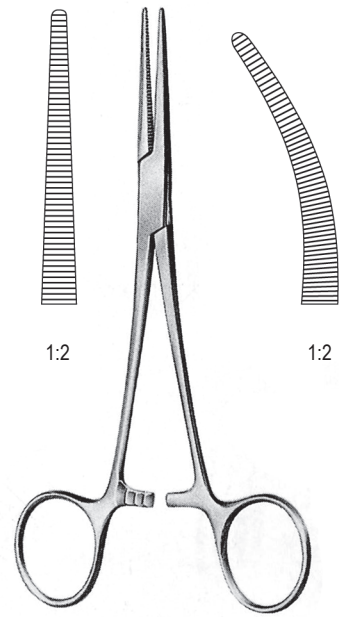

**CRILE-RANKIN**

G14.0106.16 16.0cm G14.0107.16

**G14-004** G14.0107.16



DE Arterienklemmen  
EN Artery Forceps  
ES Pinzas hemostaticas  
AR الملقط الشريان

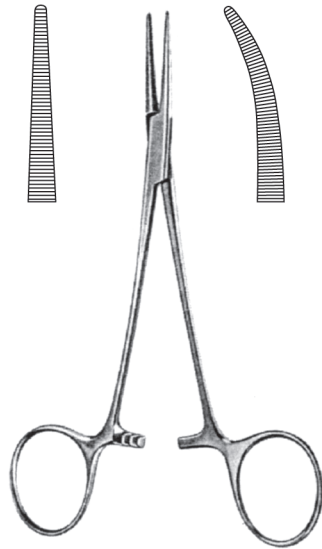

**CRILE-DELICATE**  
G14.0110.14 14.0cm G14.0111.14

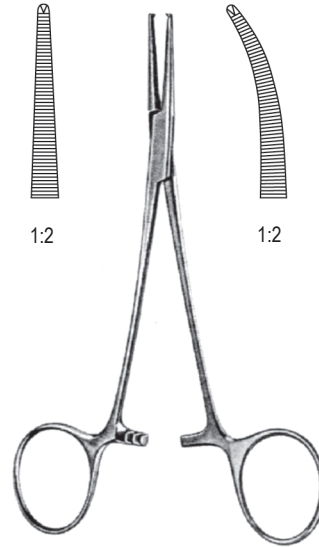

**CRILE-DELICATE**  
G14.0116.14 14.0cm G14.0117.14

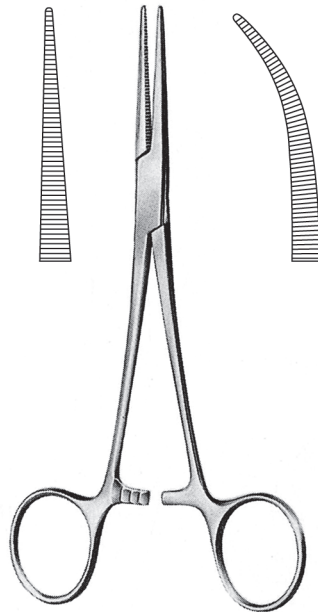

**COLLER-CRILE**  
G14.0120.14 14.0cm G14.0121.14  
G14.0120.16 16.0cm G14.0121.16

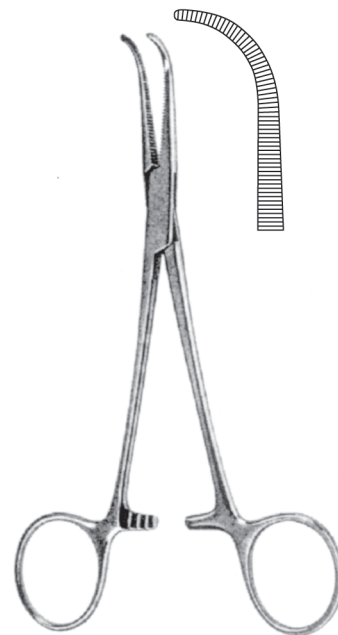

**COLLER-CRILE**  
G14.0126.16 16.0cm

G14.0126.16 **G14-005**



# G14

Arterienklemmen DE

Artery Forceps EN

Pinzas hemostaticas ES

الملقط الشريان AR

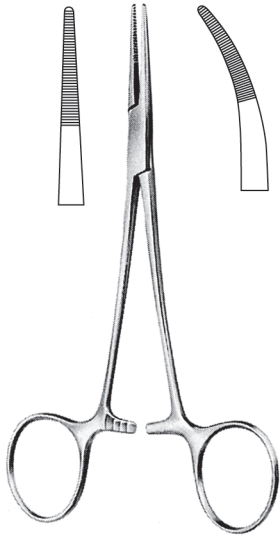

**PROVIDENCE-HOSPITAL**  
G14.0130.14 14.0cm G14.0131.14

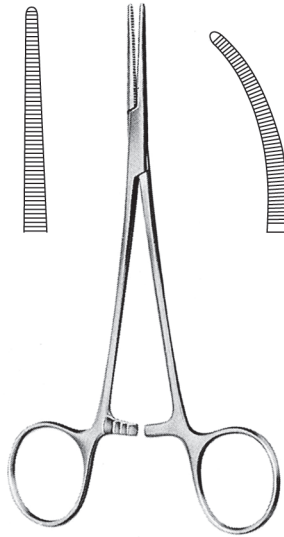

**LERICHE**  
G14.0136.15 15.0cm G14.0137.15

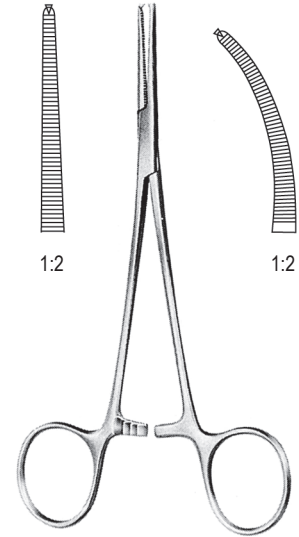

**LERICHE**  
G14.0138.15 15.0cm G14.0139.15

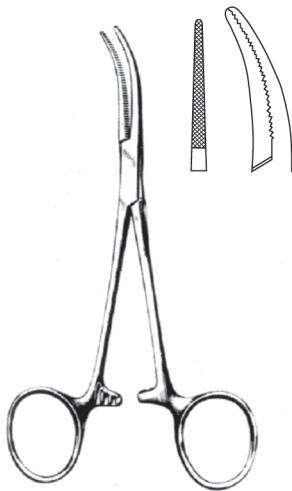

**BABY-DANDY**  
G14.0140.12 12.0cm

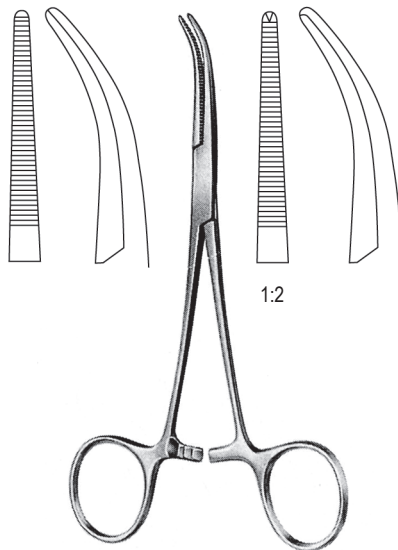

**DANDY**  
G14.0142.14 14.0cm G14.0144.14

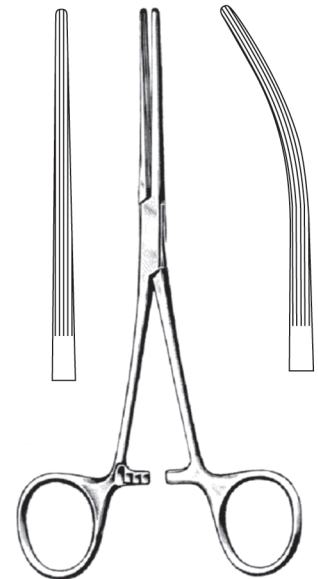

**BAINBRIDGE**  
G14.0150.15 15.0cm G14.0151.15  
G14.0150.18 18.5cm G14.0151.18

**G14-006** G14.0151.18



DE Arterienklemmen  
EN Artery Forceps  
ES Pinzas hemostaticas  
AR الملقط الشريان

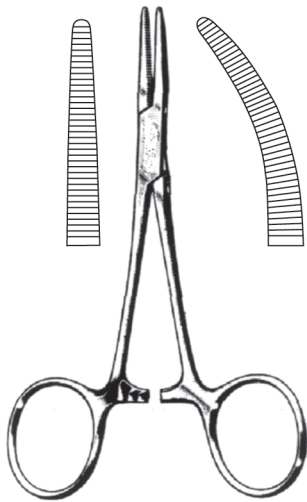

**JONES**  
G14.0156.12 12.5cm G14.0157.12  
G14.0156.15 15.0cm G14.0157.15

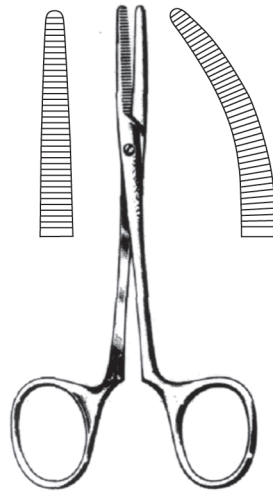

**SPENCER-WELLS**  
G14.0160.12 12.5cm G14.0161.12  
G14.0160.15 15.0cm G14.0161.15  
G14.0160.18 18.0cm G14.0161.18  
G14.0160.20 20.0cm G14.0161.20  
G14.0160.23 23.0cm G14.0161.23

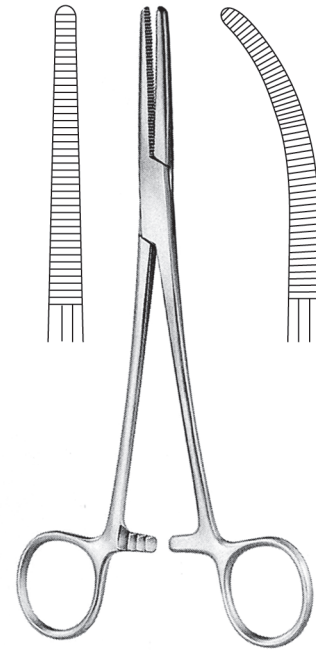

**SPENCER-WELLS**  
G14.0162.13 13.0cm G14.0163.13  
G14.0162.14 14.0cm G14.0163.14  
G14.0162.15 15.0cm G14.0163.15  
G14.0162.18 18.0cm G14.0163.18  
G14.0162.20 20.0cm G14.0163.20  
G14.0162.23 23.0cm G14.0163.23

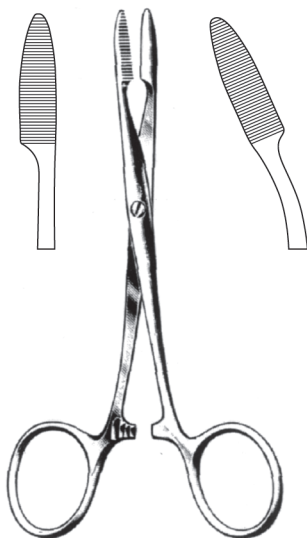

**PEAN**  
G14.0170.12 12.5cm G14.0171.12  
G14.0170.14 14.0cm G14.0171.14  
G14.0170.16 16.0cm G14.0171.16

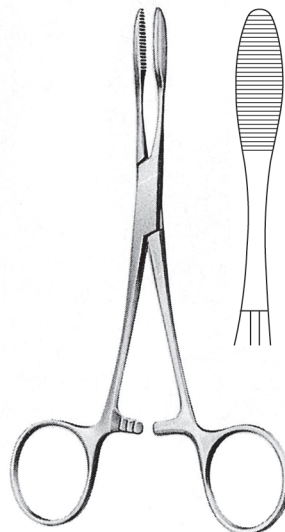

**PEAN**  
G14.0172.12 12.5cm  
G14.0172.14 14.0cm  
G 14.0172.16 16.0cm

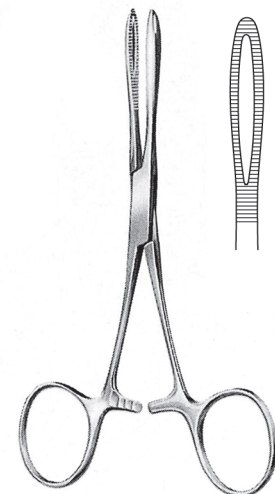

**KROENLIEN**  
G14.0176.14 14.0cm G14.0178.14

G14.0178.14 **G14-007**





# G14

Arterienklemmen DE

Artery Forceps EN

Pinzas hemostaticas ES

الملقط الشريان AR

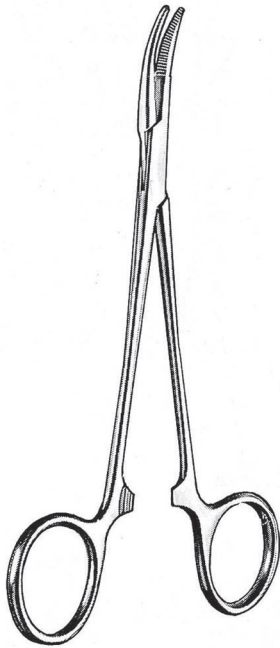

**CAIRNS**

G14.0180.14 14.5cm G14.0181.14

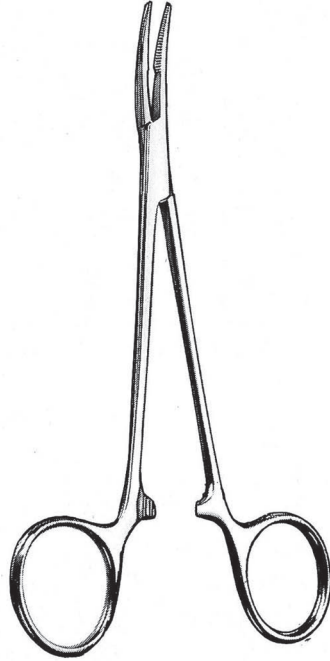

**CUSHING**

G14.0186.14 14.0cm G14.0187.14

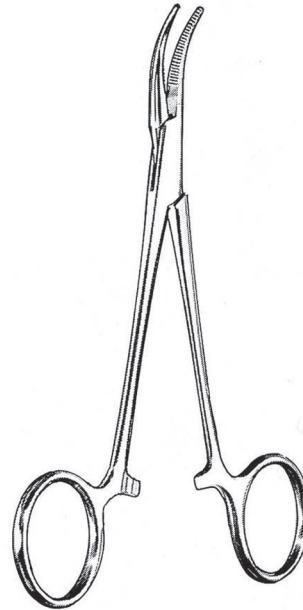

**KILNER**

G14.0190.14 14.0cm G14.0191.14

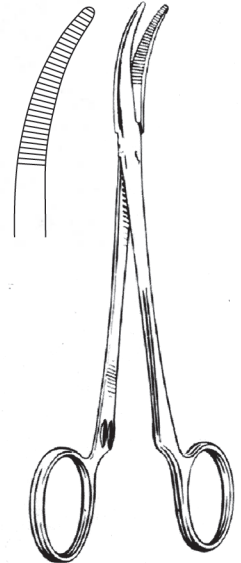

**KELLY**

G14.0196.12 12.5cm

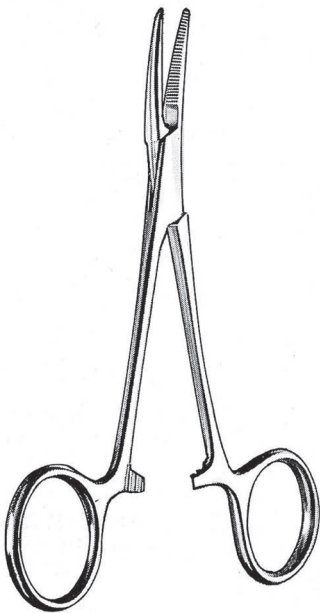

**DUNHILL**

G14.0200.12 12.5cm G14.0201.12

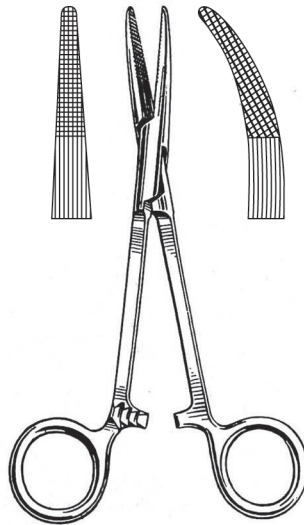

**GREY-TURNER**

G14.0206.15 15.0cm G14.0207.15

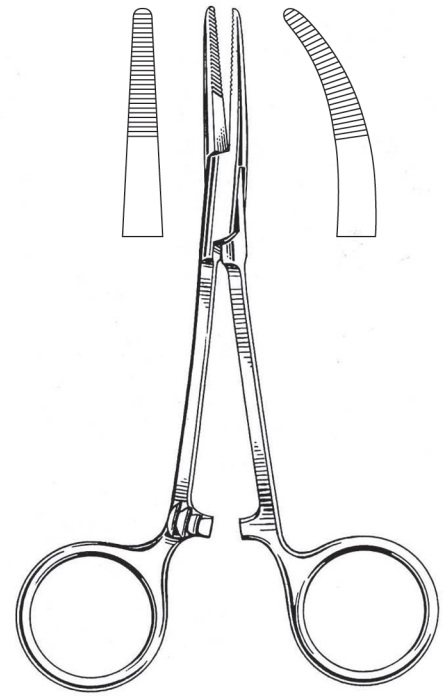

**MOYNIHAN**

G14.0210.14 14.5cm G14.0211.14

**G14-008** G14.0211.14



DE Arterienklemmen  
EN Artery Forceps  
ES Pinzas hemostaticas  
AR الملقط الشريان

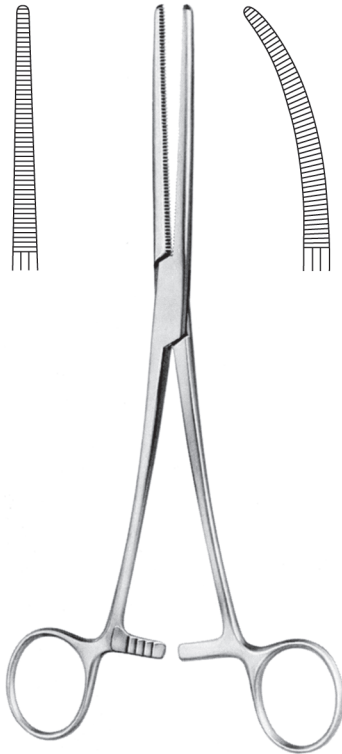

**PEAN (ROCHESTER)**

G14.0220.13	13.0cm	G14.0221.13
G14.0220.14	14.0cm	G14.0221.14
G14.0220.16	16.0cm	G14.0221.16
G14.0220.18	18.0cm	G14.0221.18
G14.0220.20	20.0cm	G14.0221.20
G14.0220.22	22.0cm	G14.0221.22
G14.0220.24	24.0cm	G14.0221.24
G14.0220.26	26.0cm	G14.0221.26
G14.0220.28	28.0cm	G14.0221.28
G14.0220.30	30.0cm	G14.0221.30

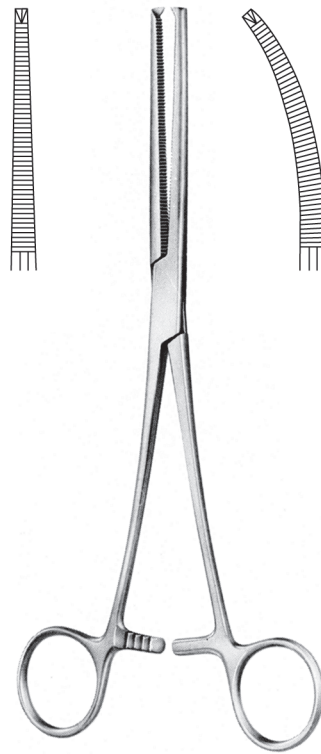

**KOCHER (OCHSNER)**

G14.0226.13	13.0cm	G14.0227.13
G14.0226.14	14.0cm	G14.0227.14
G14.0226.16	16.0cm	G14.0227.16
G14.0226.18	18.0cm	G14.0227.18
G14.0226.20	20.0cm	G14.0227.20
G14.0226.22	22.0cm	G14.0227.22
G14.0226.24	24.0cm	G14.0227.24
G14.0226.26	26.0cm	G14.0227.26
G14.0226.28	28.0cm	G14.0227.28
G14.0226.30	30.0cm	G14.0227.30



# G14

Arterienklemmen DE

Artery Forceps EN

Pinzas hemostaticas ES

الملقط الشريان AR

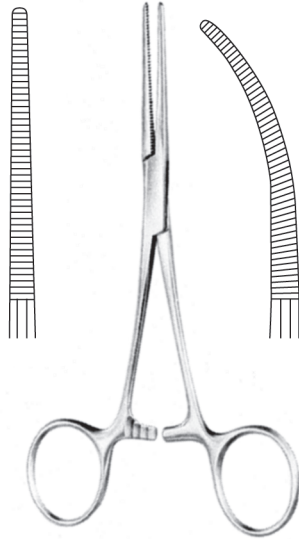

**PEAN (DELICATE)**

G14.0230.13 13.0cm G14.0231.13  
G14.0230.14 14.0cm G14.0231.14  
G14.0230.16 16.0cm G14.0231.16

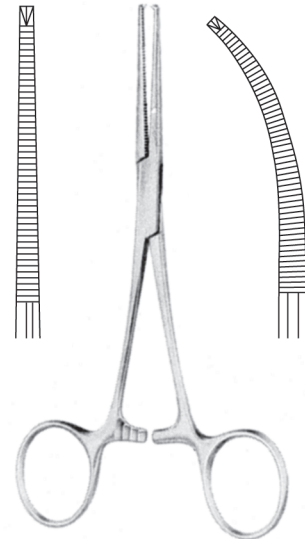

**KOCHER (DELICATE)**

G14.0236.13 13.0cm G14.0237.13  
G14.0236.14 14.0cm G14.0237.14  
G14.0236.16 16.0cm G14.0237.16

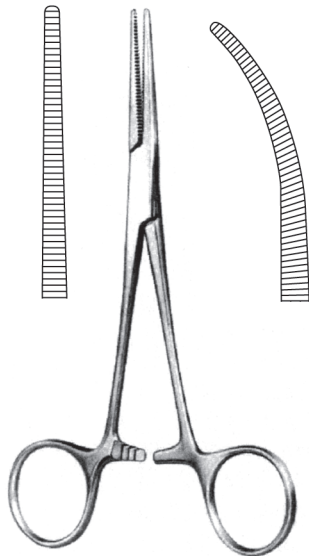

**PEAN-NIPPON**

G14.0240.14 14.5cm G14.0241.14  
G14.0240.16 16.0cm G14.0241.16  
G14.0240.18 18.0cm G14.0241.18

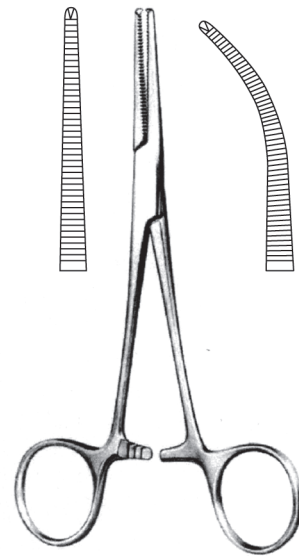

**KOCHER-NIPPON**

G14.0246.14 14.5cm G14.0247.14  
G14.0246.16 16.0cm G14.0247.16  
G14.0246.18 18.0cm G14.0247.18

**G14-010** G14.0247.18



DE Arterienklemmen  
EN Artery Forceps  
ES Pinzas hemostaticas  
AR الملقط الشريان

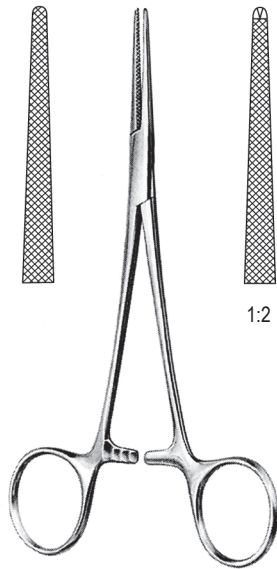

1:2

**LOVELACE**

G14.0250.15 15.5cm G14.0252.15

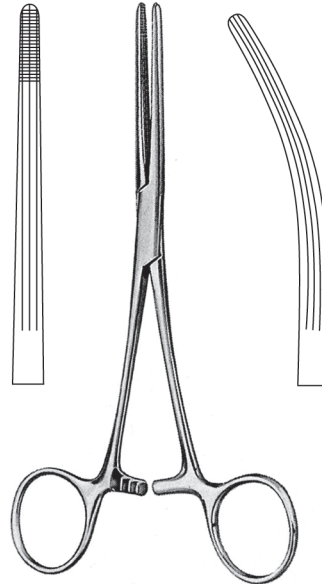

**ROCHESTER-CARMALT**

G14.0256.16 16.0cm G14.0257.16  
G14.0256.20 20.0cm G14.0257.20



**HOSEMANN**

G14.0260.21 21.0cm G14.0262.21



**ADSON**

G14.0270.18 18.5cm G14.0271.18

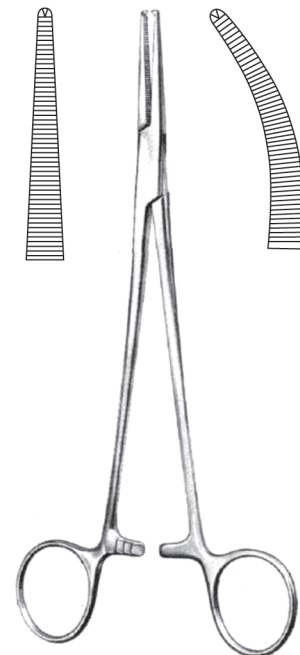

**ADSON**

G14.0272.18 18.5cm G14.0273.18

G14.0273.18 **G14-011**



# G14

Arterienklemmen DE

Artery Forceps EN

Pinzas hemostaticas ES

الملقط الشريان AR

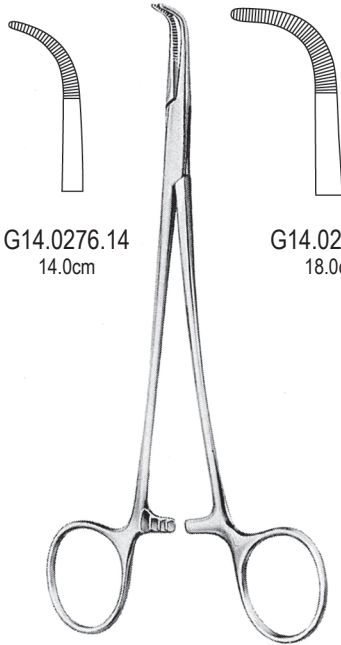

G14.0276.14  
14.0cm

G14.0276.18  
18.0cm

**BABY-ADSON**



G14.0280.12 12.0cm

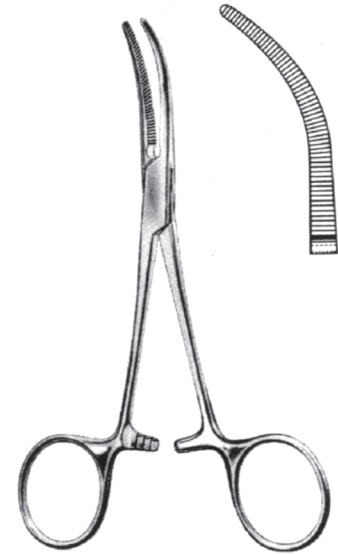

**BABY-OVERHOLT**  
G14.0290.13 13.5cm



**MIXTER BABY**  
G14.0292.14 14.0cm

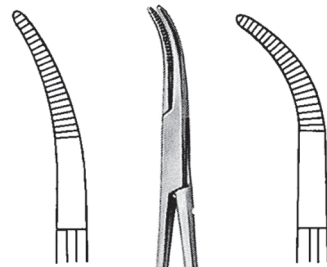

G14.0294.14

G14.0296.14

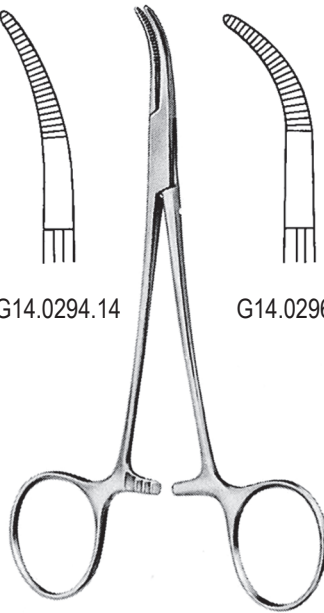

**BABY-MIXTER**  
14.0cm

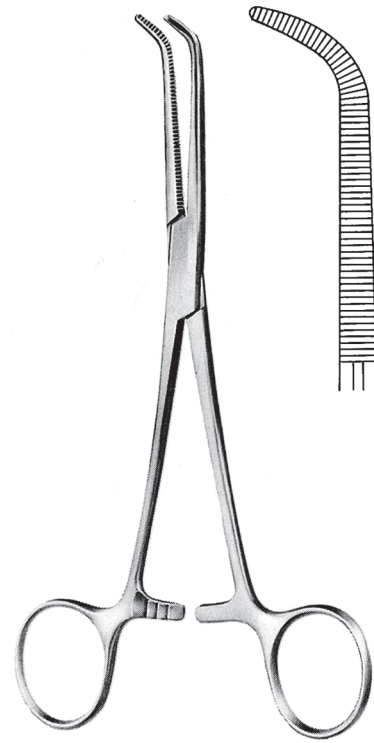

**BABY-MIXTER**  
G14.0298.18 18.0cm

**G14-012** G14.0298.18



DE Arterienklemmen  
EN Artery Forceps  
ES Pinzas hemostaticas  
AR الملقط الشريان

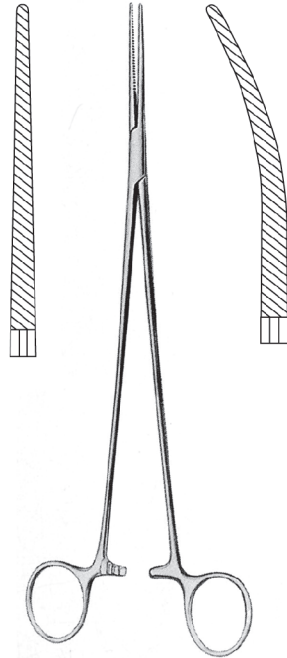

**BENGOLEA**

G14.0300.20 20.0cm G14.0301.20  
G14.0300.24 24.0cm G14.0301.24  
G14.0300.26 26.0cm G14.0301.26

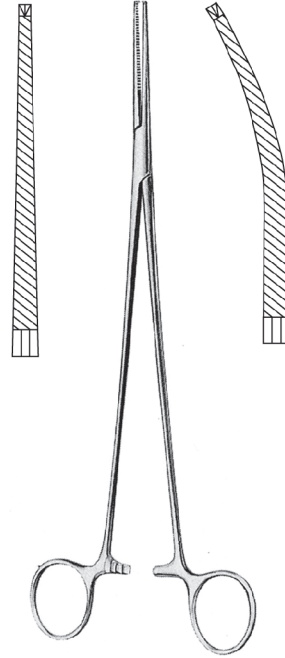

**BENGOLEA**

G14.0302.20 20.0cm G14.0303.20  
G14.0302.24 24.0cm G14.0303.24  
G14.0302.26 26.0cm G14.0303.26

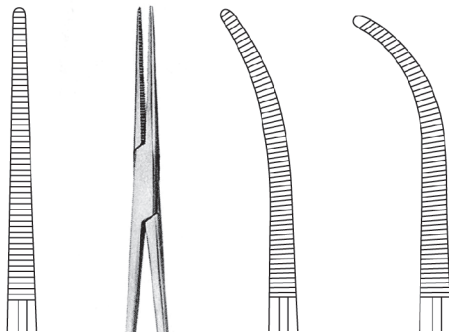

G14.0310.20

G14.0311.20

G14.0313.20



**HEISS**  
20.0cm

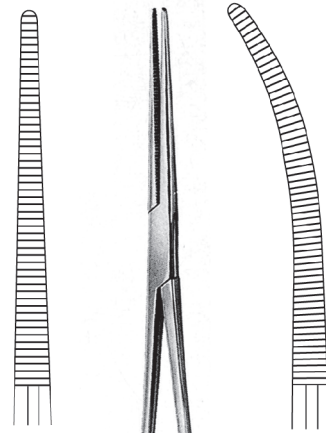

G14.0316.22

G14.0317.22



22.0cm

G14.0317.22 **G14-013**



# G14

Präparier- und Ligaturklemmen DE

Dissecting and ligature Forceps EN

Pinzas para preparaciones y ligaduras ES

تشریح والملقط ضد AR

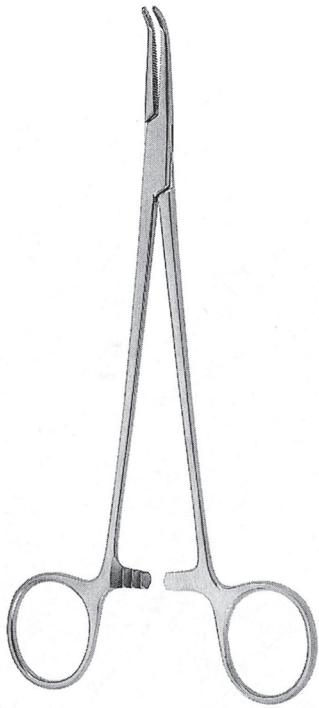

## MINI-GEMINI

G14.0320.18  
18.0cm

G14.0320.22  
22.0cm

G14.0320.25  
25.0cm

G14.0320.28  
28.0cm

## GEMINI

G14.0322.13  
13.0cm

G14.0322.16  
16.0cm

G14.0322.18  
18.0cm

G14.0322.20  
20.0cm

G14.0322.23  
23.0cm

G14.0322.25  
25.0cm

G14.0322.28  
28.0cm

G14-014 G14.0322.28

DE Arterienklemmen  
 EN Artery Forceps  
 ES Pinzas hemostaticas  
 AR الملقط الشريان



**OVERHOLT-GEISSENDOERFER**

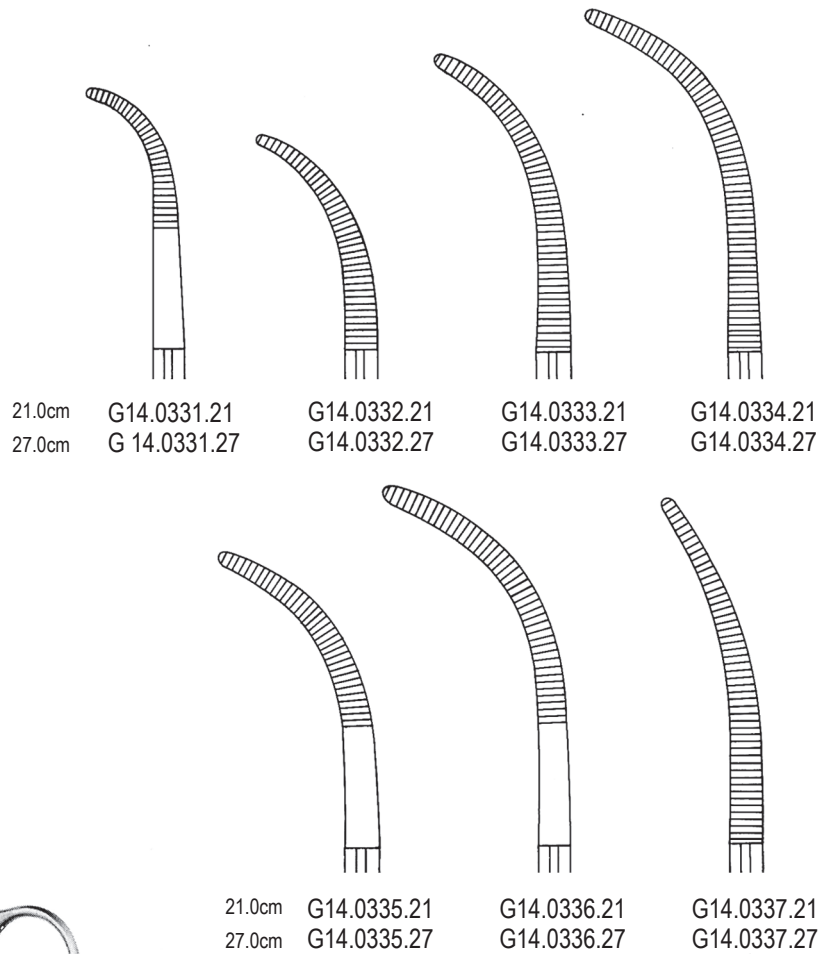

G14.0337.27 **G14-015**





# G14

Präparier- und Ligaturklemmen DE

Dissecting and ligature Forceps EN

Pinzas para preparaciones y ligaduras ES

تشریح والملقط ضد AR



**OVERHOLT**

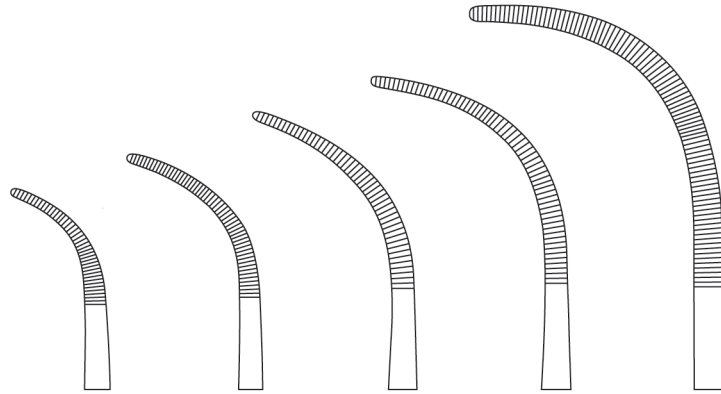

G14.0340.01  
18.5cm

G14.0340.02  
20.5cm

G14.0340.03  
21.0cm

G14.0340.04  
21.5cm

G14.0340.05  
24.0cm

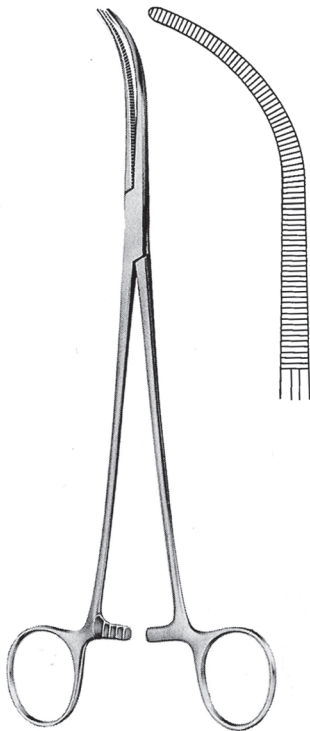

**OVERHOLT-MIXTER**  
G14.0342.21 21.0cm

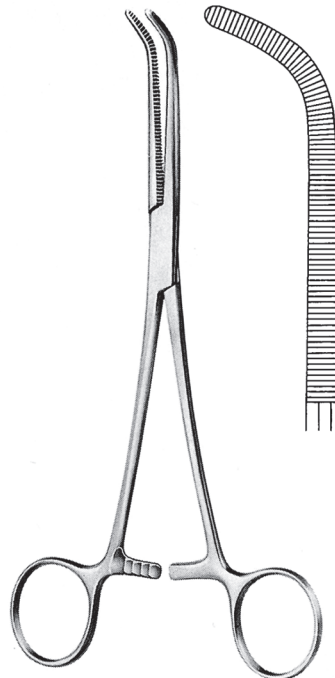

**MIXTER**  
G14.0344.22 22.0cm

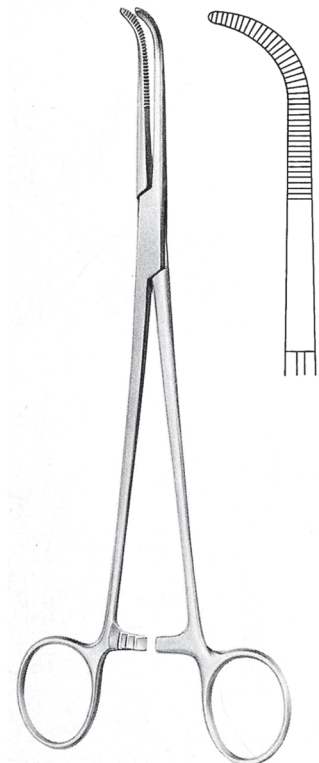

**MIXTER**  
G14.0346.23 23.0cm

**G14-016** G14.0346.23



- DE Arterienklemmen, Präparier- und Ligaturklemmen
- EN Artery Forceps, Dissecting and ligature Forceps
- ES Pinzas hemostáticas, pinzas para preparaciones y ligaduras
- AR الملقط الشريان، تشريح و الملقط ضد

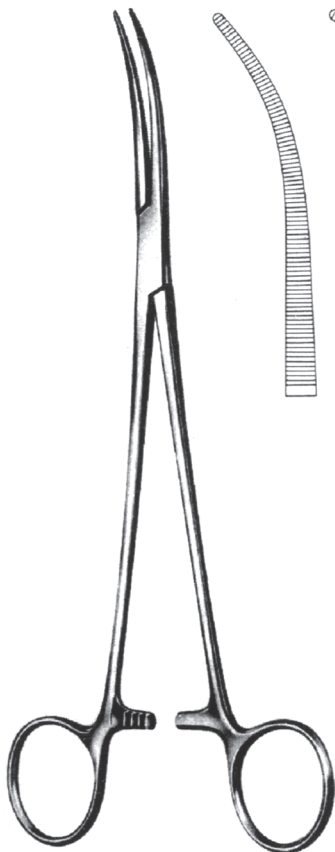

**KELLY**

19.0 cm G14.0350.19 G14.0351.19 G14.0353.19  
22.0 cm G14.0350.22 G14.0351.22 G14.0353.22  
24.0 cm G14.0350.24 G14.0351.24 G14.0353.24

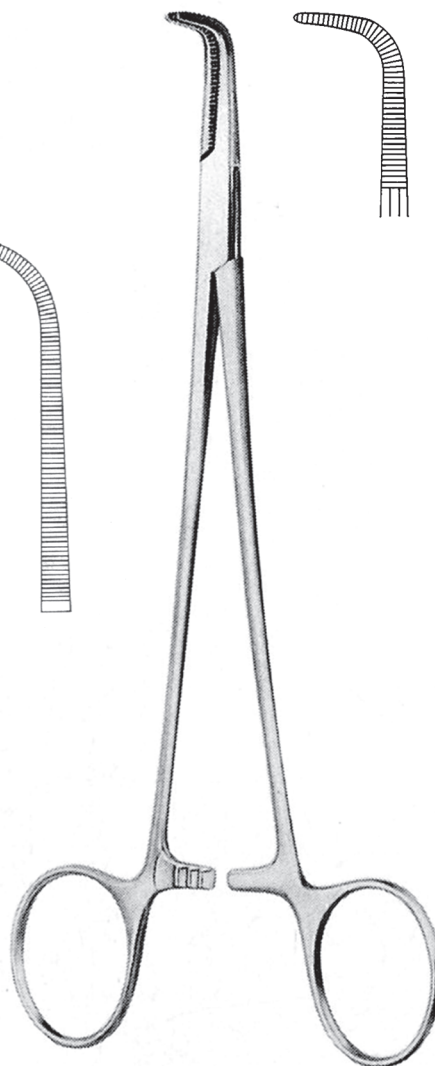

**MEEKER**

G14.0356.27 27.5 cm

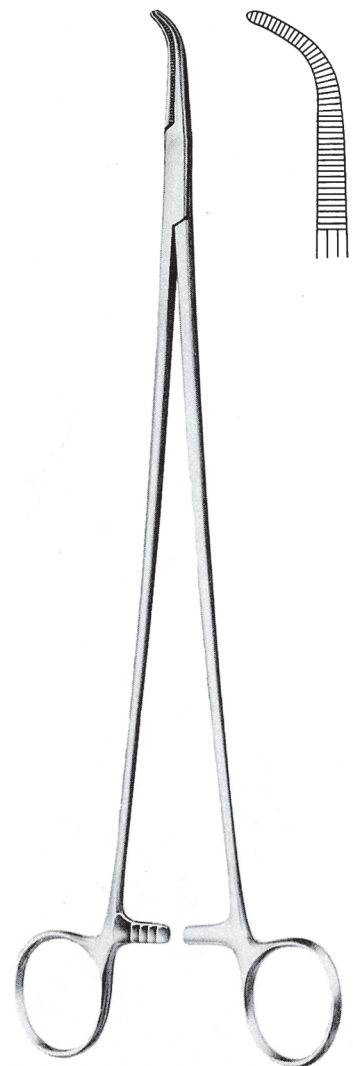

**LAWRENCE**

G14.0358.27 27.5 cm

G14.0358.27 **G14-017**



# G14

Arterienklemmen, Parparier DE

Artery Forceps, Dissecting Forceps EN

Pinzas hemostaticas, pinzas para preparaciones ES

الملقط الشريان، الملقط تشريح AR

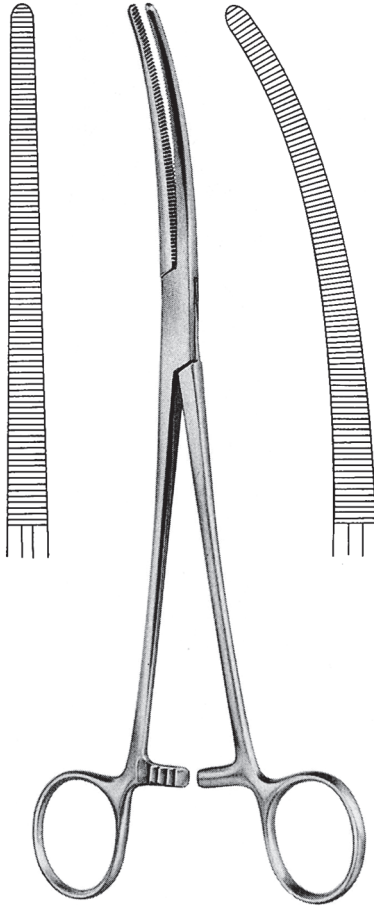

**SAROT**  
G14.0360.24 24.0cm G14.0361.24

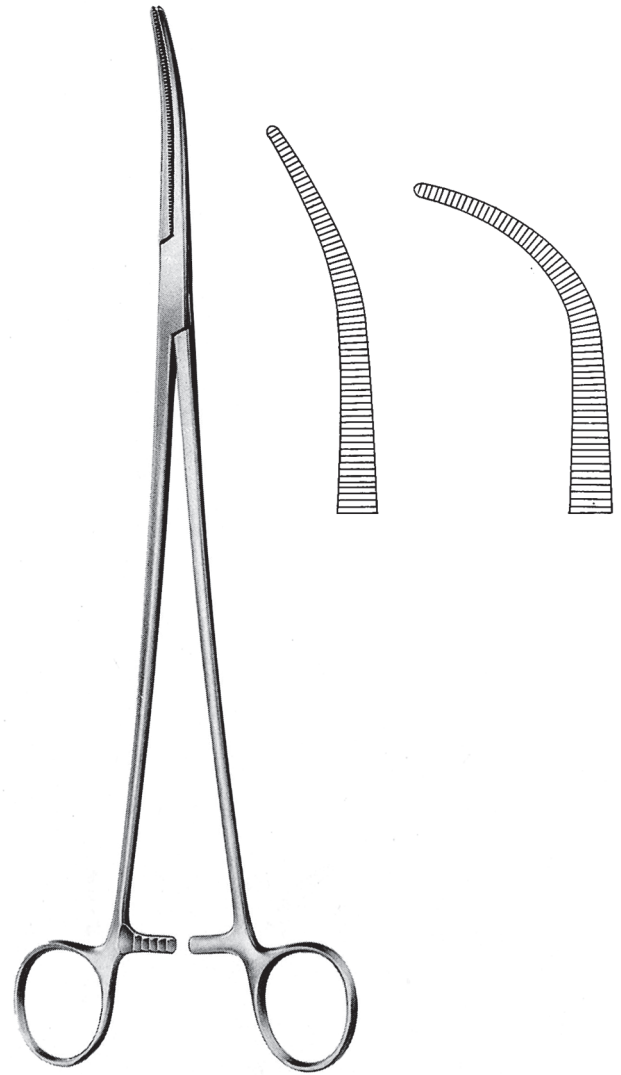

**ZENKER**  
G14.0366.01 29.5cm G14.0366.02

G14-018 G14.0366.02



DE Arterienklemmen, Präparier- und Ligaturklemmen  
 EN Artery Forceps, Dissecting and ligature Forceps  
 ES Pinzas hemostaticas, pinzas para preparaciones y ligaduras  
 AR الملقط الشريان، تشريح و الملقط ضد

**G14**

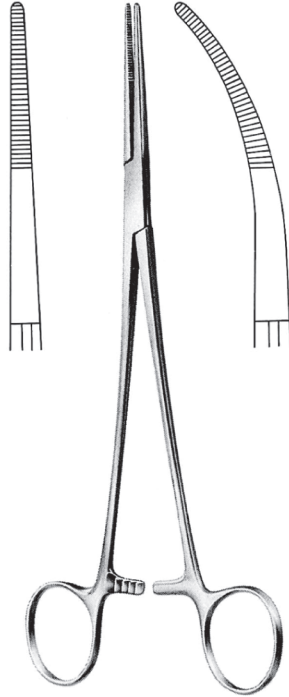

**TOENNIS**

G14.0370.21 21.0cm G14.0371.21  
 G14.0370.26 26.0cm G14.0371.26

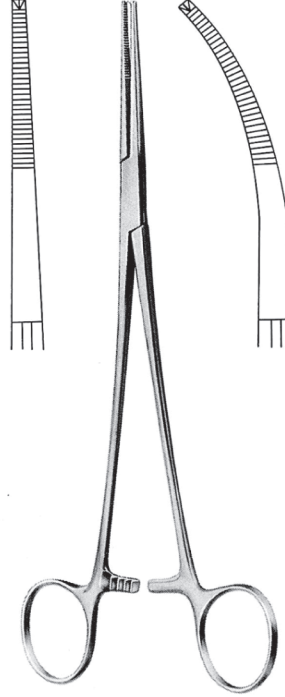

**TOENNIS**

G14.0372.21 21.0cm G14.0373.21  
 G14.0372.26 26.0cm G14.0373.26

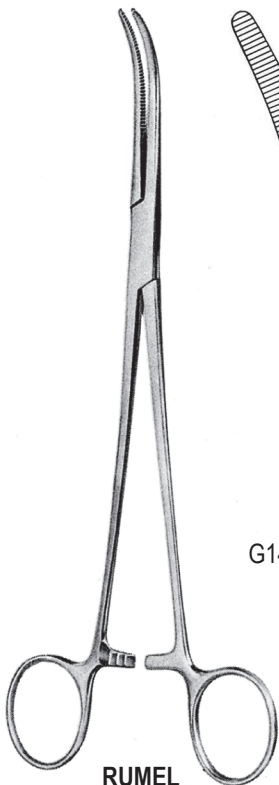

**RUMEL**  
23.0cm

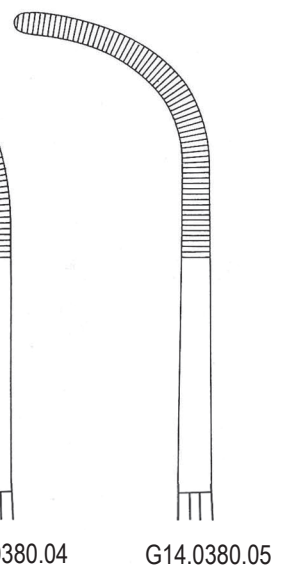
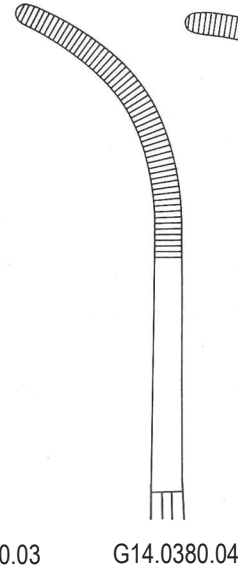
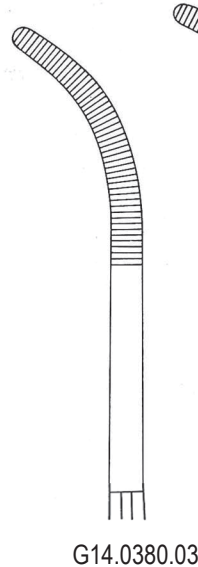
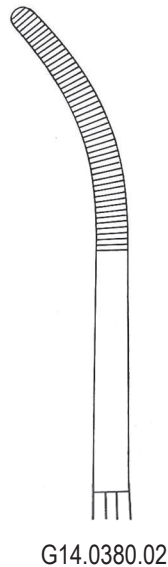
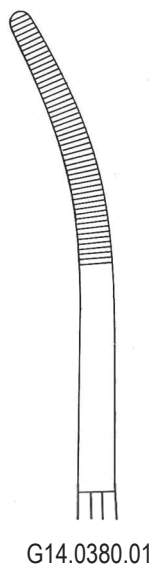

G14.0380.05 **G14-019**



# G14

Arterienklemmen, Präparier- und Ligaturklemmen DE

Artery Forceps, Dissecting and ligature Forceps EN

Pinzas hemostaticas, pinzas para preparaciones y ligaduras ES

الملقط الشريان، تشريح والملقط ضد AR

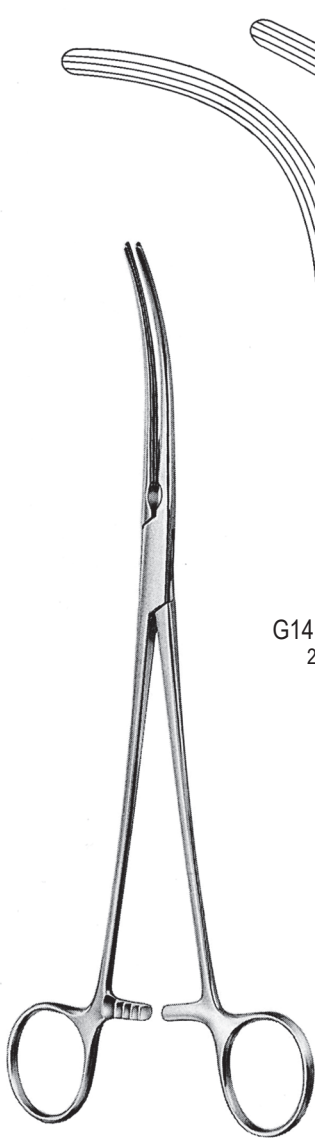

**CRAFOORD-SELLORS**

G14.0386.01  
22.0cm

G14.0386.02  
23.0cm

G14.0386.03  
24.0cm

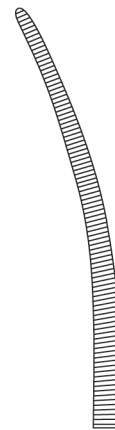

G14.0390.18  
18.0cm

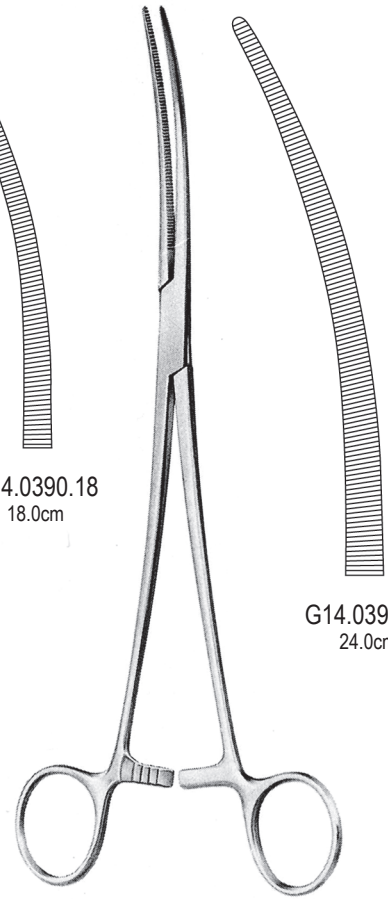

G14.0390.24  
24.0cm

**CRAFOORD**

G14-020 G14.0390.24



DE Arterien-Gallenkanal-und Nierenstielklemmen  
 EN Artery Forceps, Gall Duct and Kidney Pedicle Clamp Forceps  
 ES Pinzas-gallenkanal-und nierenstielklemmen  
 AR الملقط المرارة، الشريان والكلي عنيق المشابك

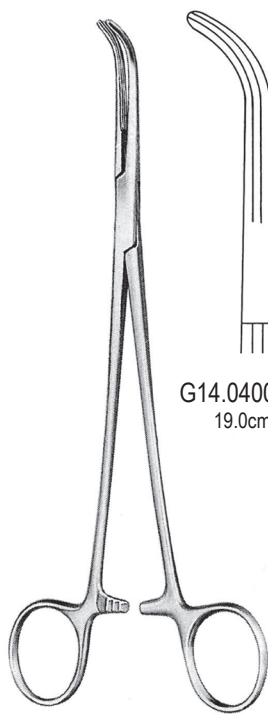

G14.0400.19  
19.0cm



G14.0400.23  
23.0cm

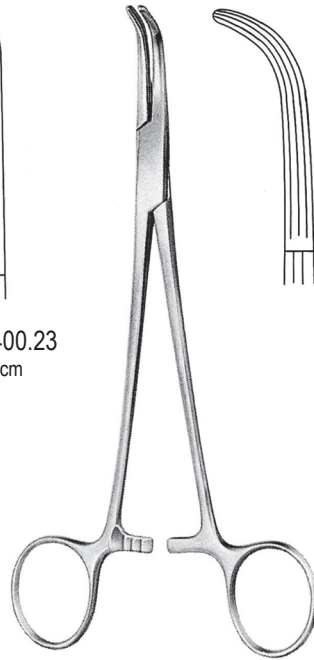

**LOWER**  
G14.0406.18 18.0cm



G14.0410.21  
21.0cm

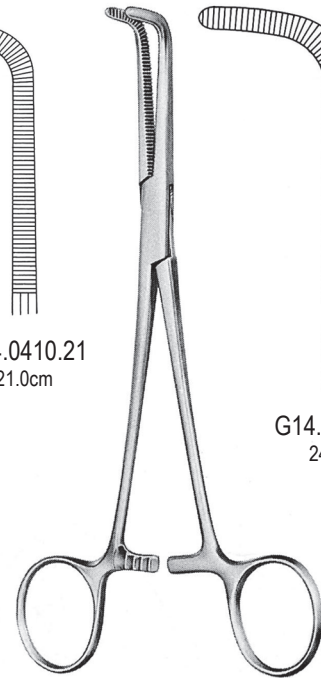

**WICKSTRÖM**

G14.0410.24  
24.0cm

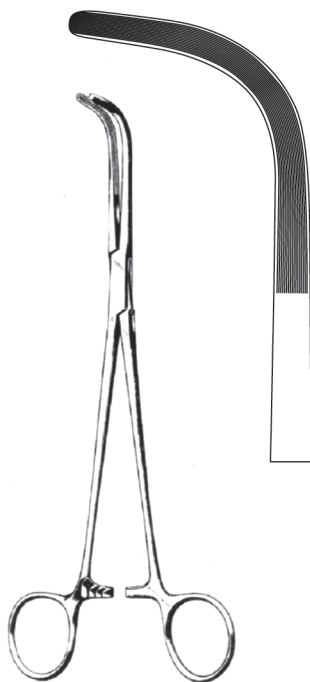

**McQUIGG-MIXTER**  
G14.0416.22 22.0cm

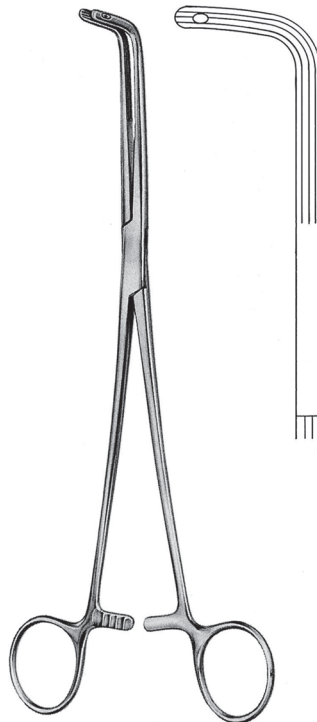

**FINOCHIETTO**  
G14.0420.24 24.0cm

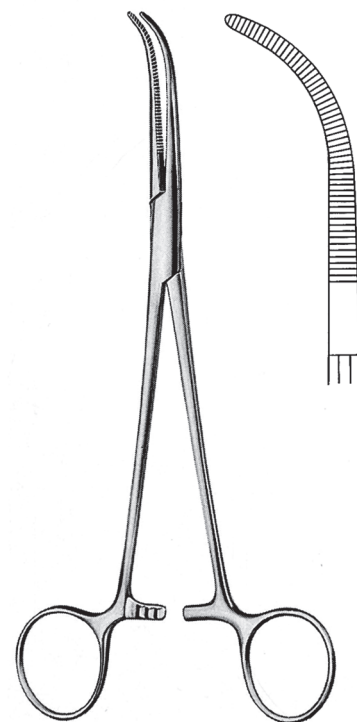

**JOHNS HOPKINS**  
G14.0426.20 20.0cm



# G14

Arterien-Gallenkanal-und Nierenstielkemma DE  
 Artery Forceps, Gall Duct and Kidney Pedicle Clamp Forceps EN  
 Pinzas-gallenkanal-und nierenstielkemma ES  
 الملقط المرارة، الشريان والكلي عنيق المشابك AR

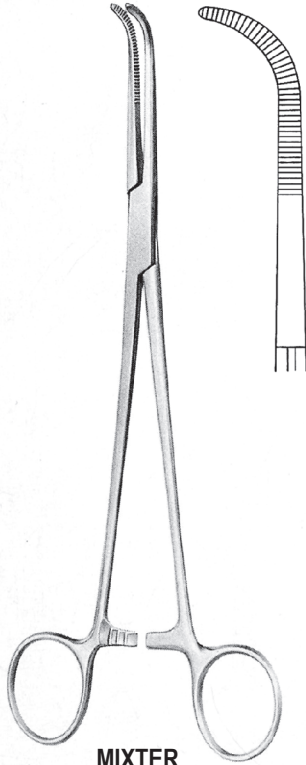

**MIXTER**  
 G14.0430.15 15.0cm  
 G14.0430.19 19.0cm

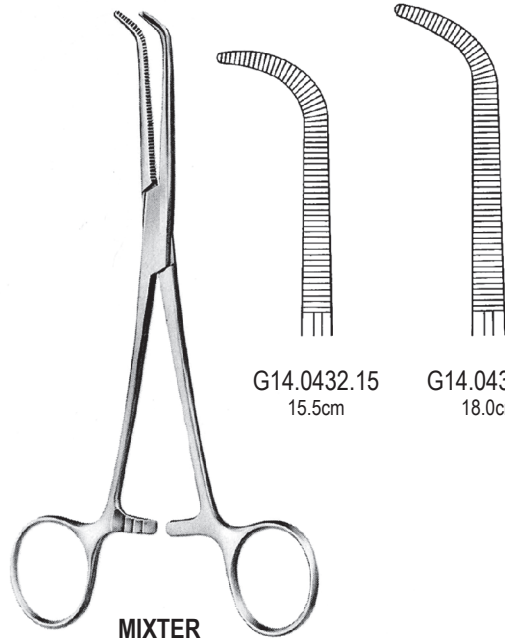

G14.0432.15 15.5cm  
 G14.0432.18 18.0cm

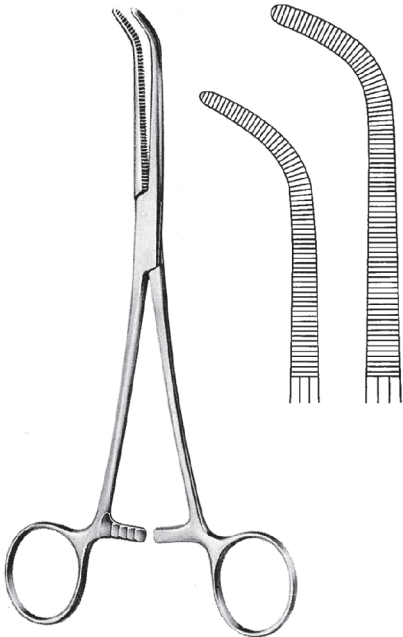

**MIXTER-O'SHAUGNESSY**  
 G14.0434.18 18.0cm  
 G14.0434.22 22.0cm

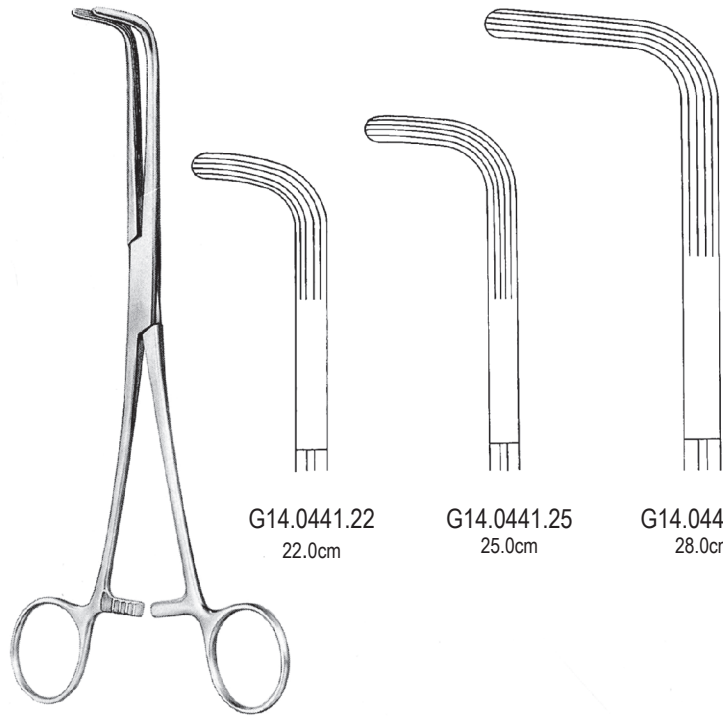

G14.0441.22 22.0cm  
 G14.0441.25 25.0cm  
 G14.0441.28 28.0cm

**MIXTER**

G14-022 G14.0441.28



DE Nierenstielklemmen

EN Kidney Pedicle Clamps Forceps

ES Pinzas-clamps para pedunculos renales

AR الملقط الكلي عنيق المشابك

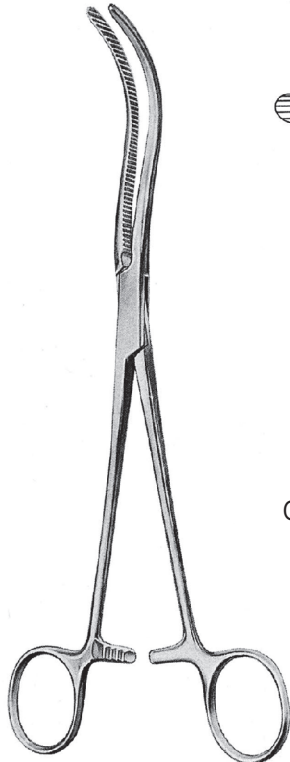

**GUYON**

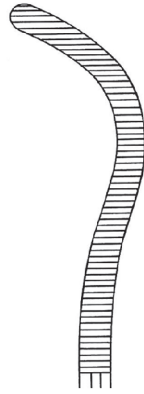

G14.0450.20  
20.0cm

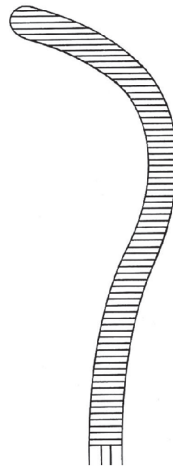

G14.0450.22  
22.0cm

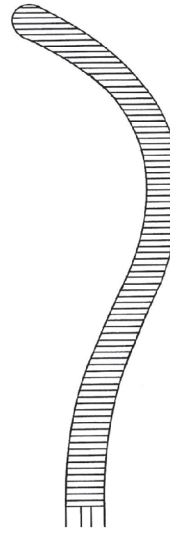

G14.0450.24  
24.0cm

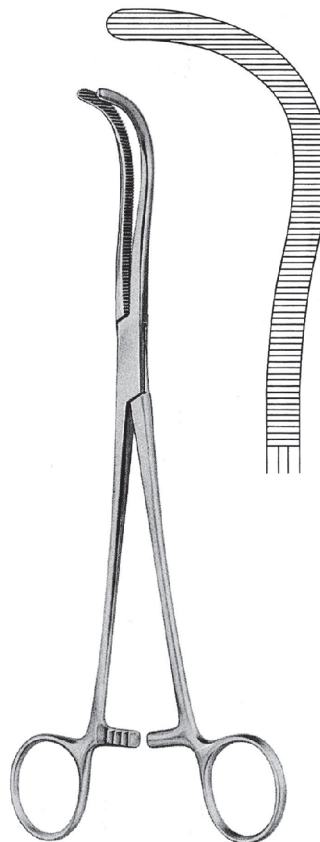

**GUYON**

G14.0452.23 23.0cm

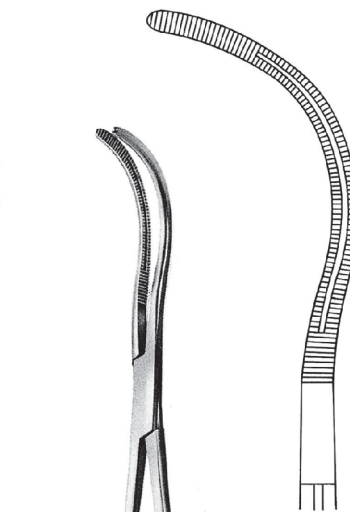

**STILLE**

G14.0454.23 23.0cm





# G14

Nierenstielkemma DE  
Kidney Pedicle Clamp Forceps EN  
Pinzas-clamps para pedunculos renales ES  
الملقط الكلي عنيق المشابك AR

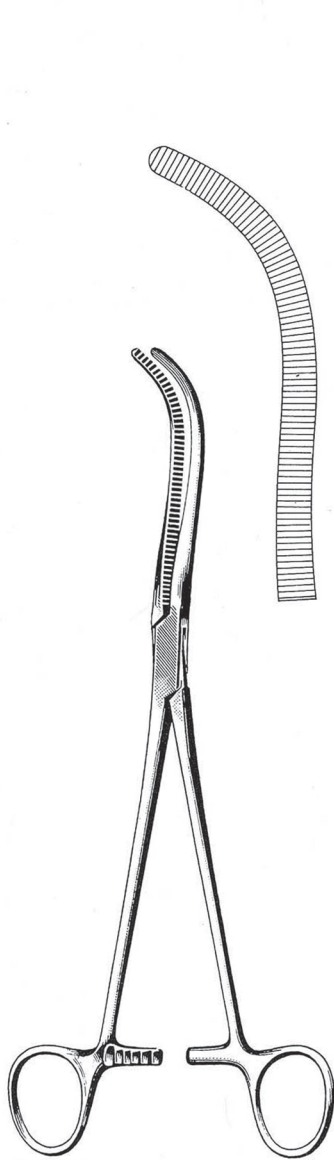

**MAYO**  
G14.0456.23 23.0cm

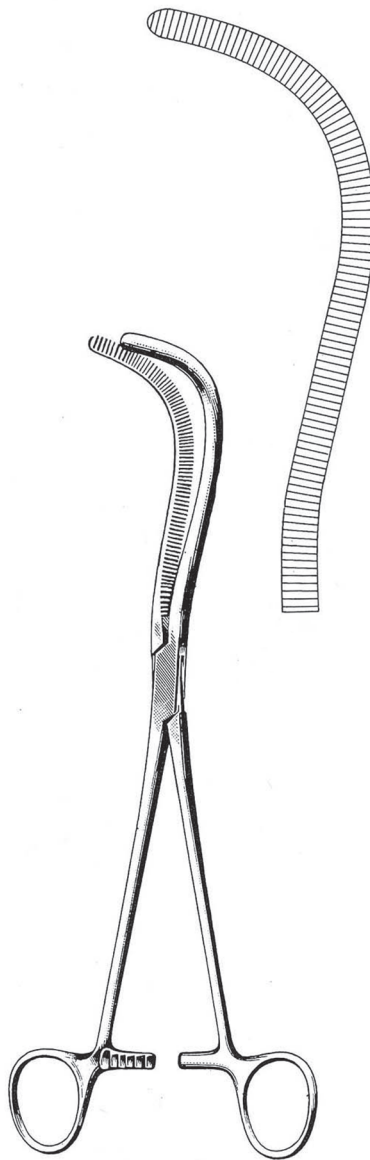

**MAYO-GUYON**  
G14.0458.23 23.0cm

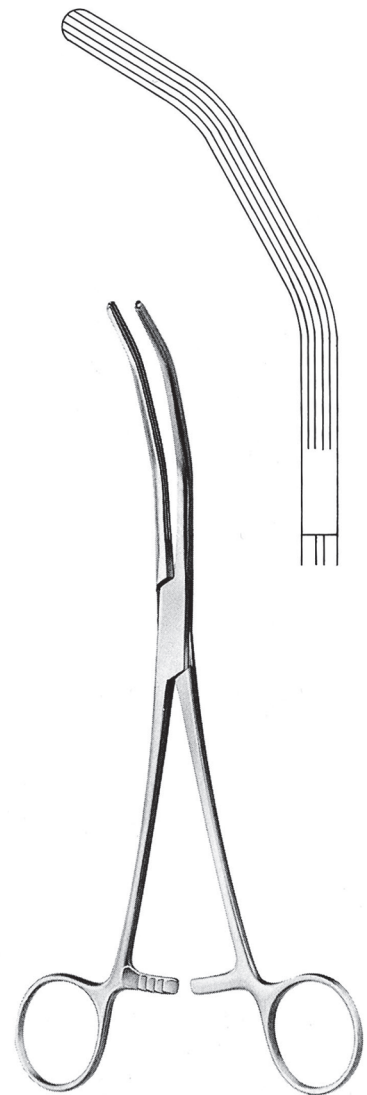

**MAYO-GUYON**  
G14.0460.23 23.0cm

**G14-024** G14.0460.23



DE Gallenkanalklemmen  
EN Gall Duct Forceps  
ES Pinzas para conducto biliar  
AR الملقط المرارة

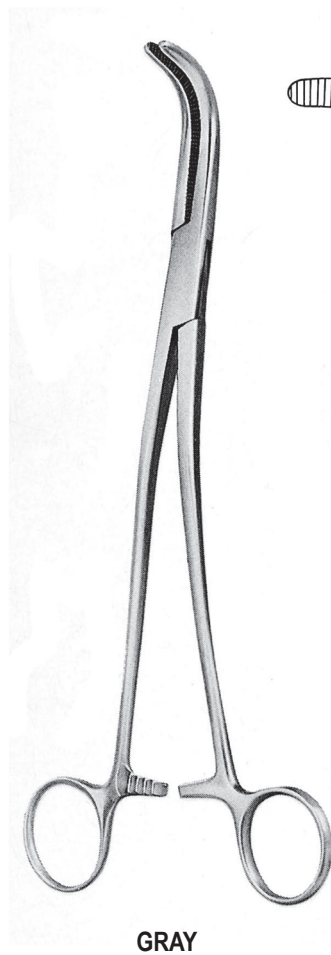

G14.0464.22  
22.0cm

G14.0464.23  
23.0cm

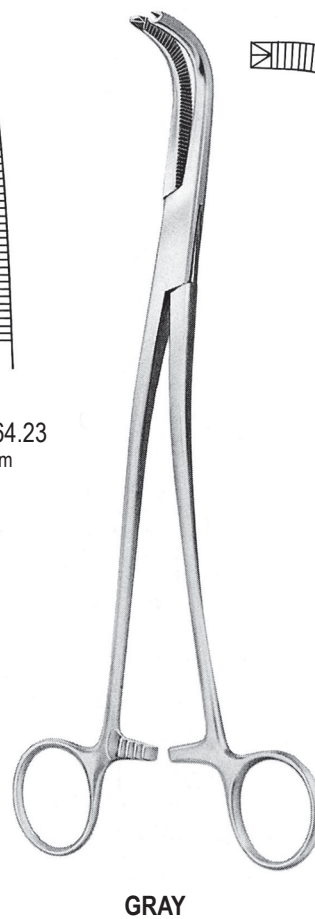

G14.0468.22  
22.0cm

G14.0468.23  
23.0cm



# G14

Gallenkanalklemmen DE  
Gall Duct Forceps EN  
Pinzas para conducto biliar ES  
الملقط المرارة AR

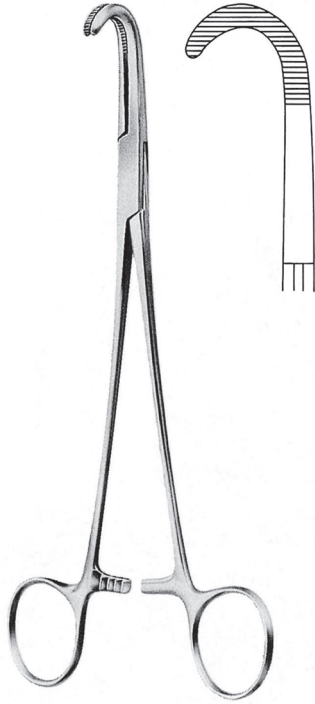

**DESJARDINS**  
G14.0470.21 21.0cm

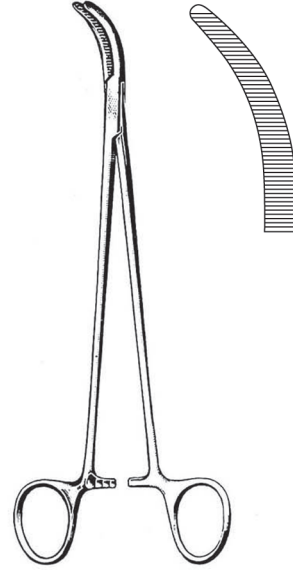

**DESJARDINS**  
G14.0472.21 21.0cm

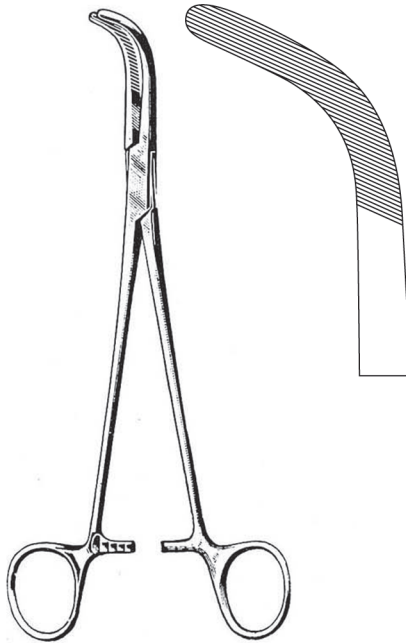

**CRILE**  
G14.0476.20 20.0cm

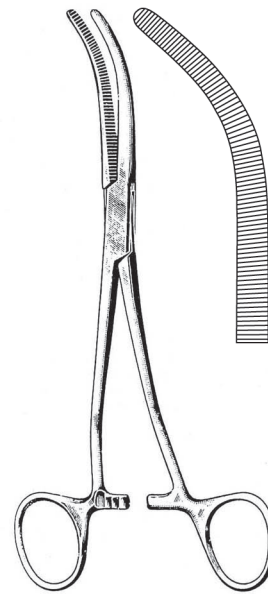

**DEAN-SHALLCROSS**  
G14.0480.18 18.0cm

**G14-026** G14.0480.18



- DE Tangentialklemmen, Nierenstielklemmen
- EN Tangential Forceps, Kidney Pedicle Clamps Forceps
- ES Pinzas tangenciales, pinzas-clamps para pedunculos Renales
- AR الملقط عرضية، الملقط الكلي عنيق المشبك

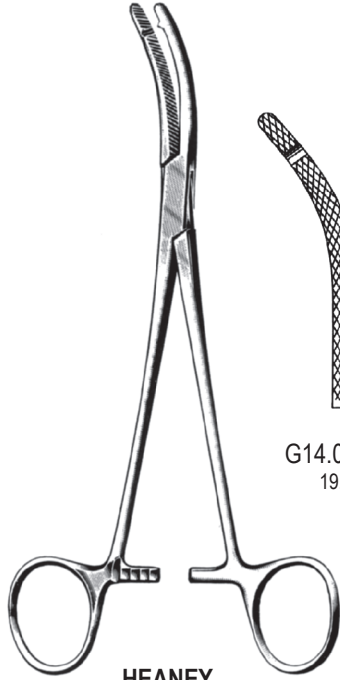

**HEANEY**

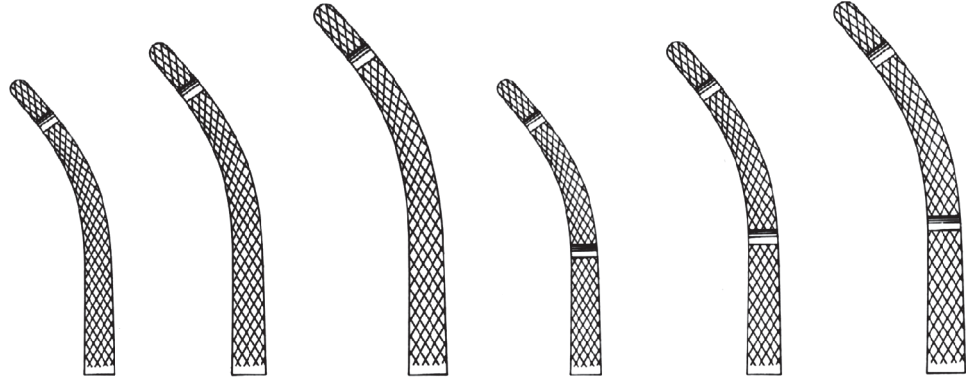

G14.0520.19  
19.5cm

G14.0520.21  
21.0cm

G14.0520.23  
23.0cm

G14.0522.19  
19.5cm

G14.0522.21  
21.0cm

G14.0522.23  
23.0cm

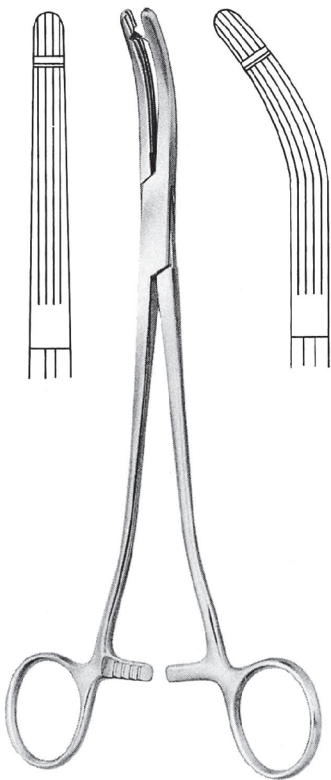

**HEANEY-BALLENTINE**

G14.0526.21 21.0cm G14.0527.21

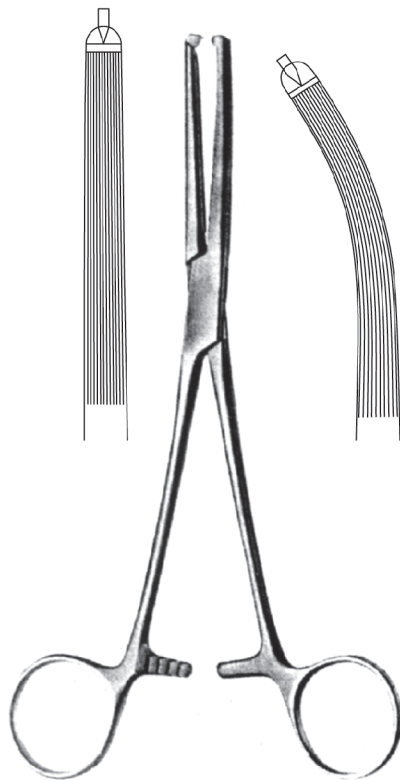

**GWILLIAM**

G14.0530.20 20.0cm G14.0531.20

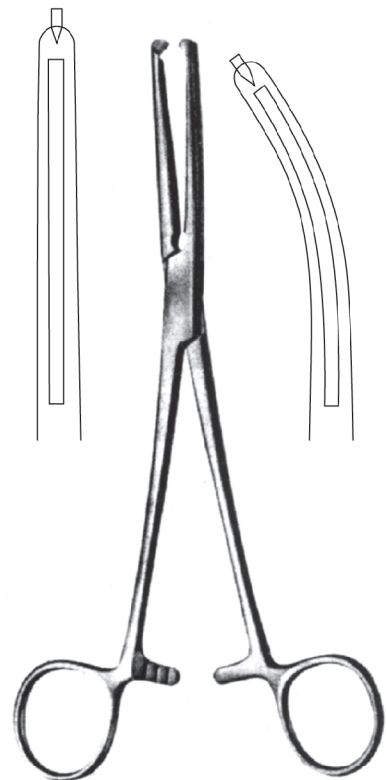

**MAINGOT**

G14.0536.20 20.0cm G14.0537.20



# G14

Peritoneumklemmen DE  
 Peritoneal Clamps Forceps EN  
 Pinzas-Clamps Para Peritoneo ES  
 الملقط الصفاقي AR

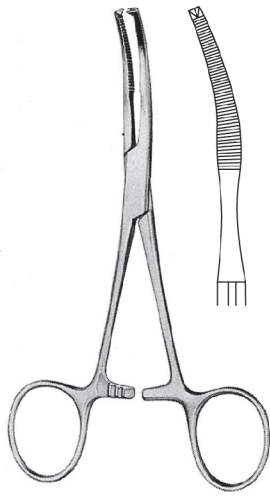

**BABY-MIKULICZ**  
G14.0500.14 14.0cm

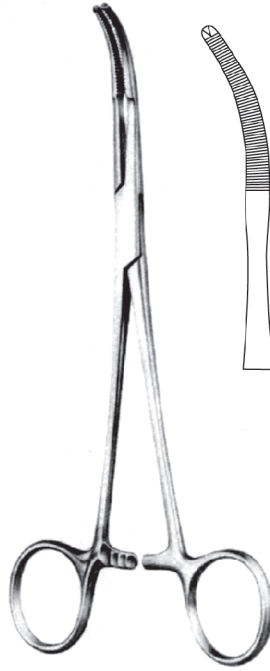

**MIKULICZ**  
G14.0500.18 18.0cm



**MIKULICZ**  
G14.0500.20 20.0cm

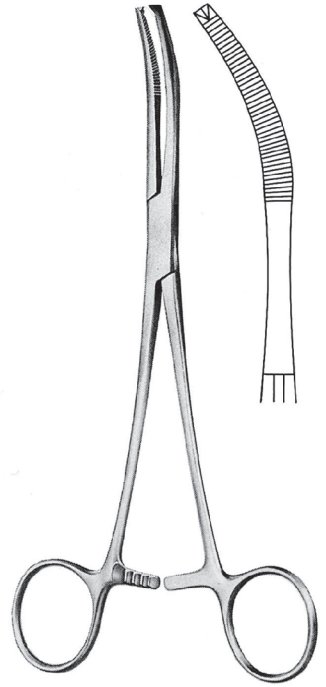

**MIKULICZ**  
G14.0502.20 20.0cm

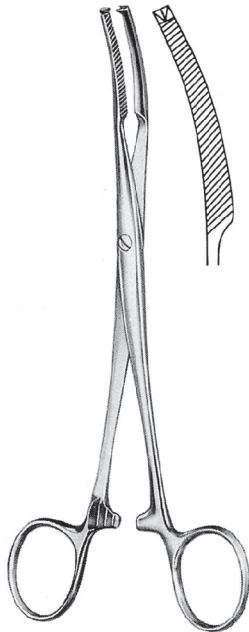

**MIKULICZ**  
G14.0504.18 18.0cm

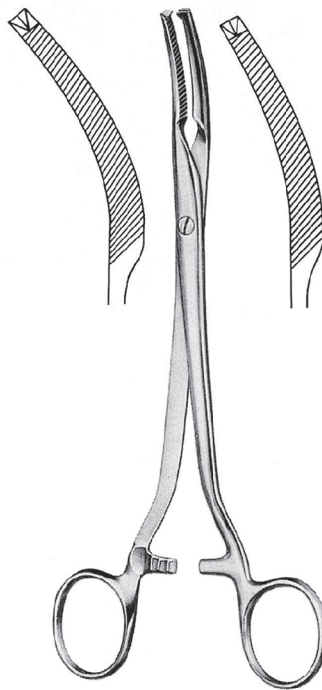

**MIKULICZ**  
G14.0506.20 20.0cm G14.0508.20

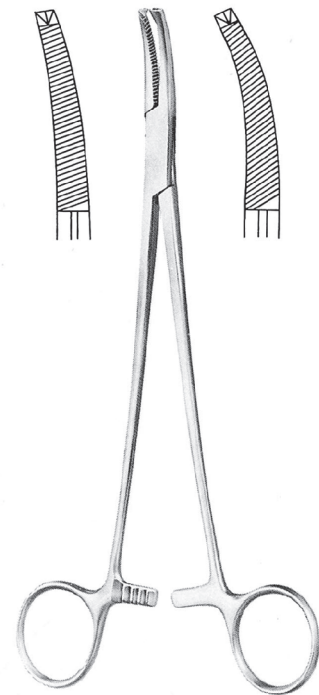

**FAURE**  
G14.0512.20 20.0cm G14.0514.20

**G14-028** G14.0514.20



DE **Hysterektomieklemmen**  
 EN **Hysterectomy Forceps**  
 ES **Pinzas Para Histerectomia**  
 AR **الملقط استئصال الرحم**

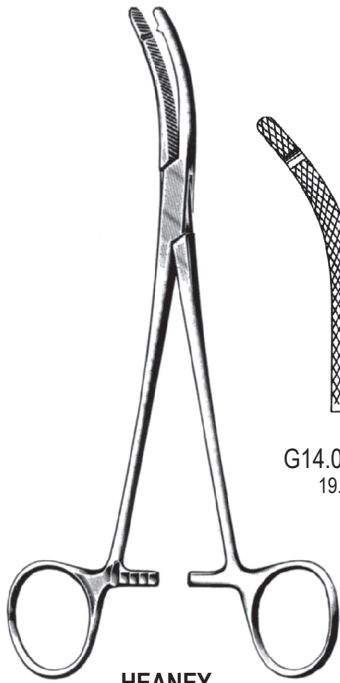

**HEANEY**

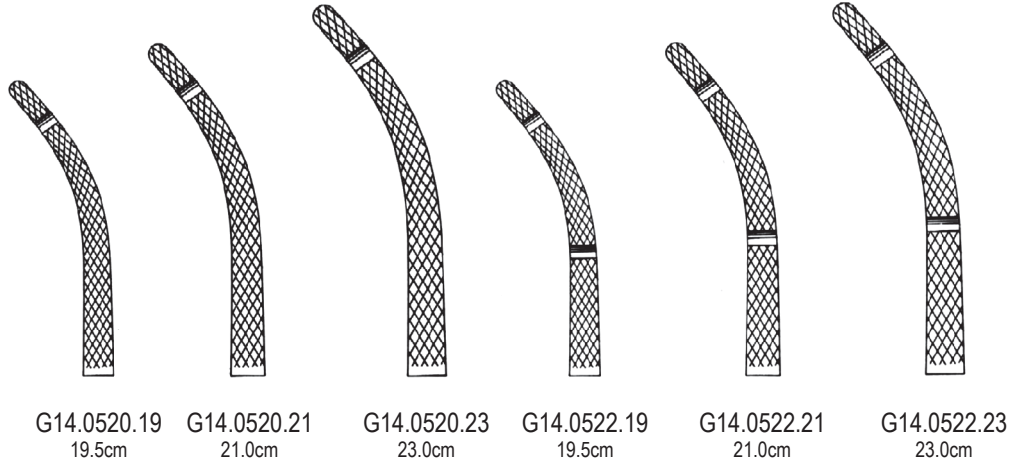

G14.0520.19  
19.5cm

G14.0520.21  
21.0cm

G14.0520.23  
23.0cm

G14.0522.19  
19.5cm

G14.0522.21  
21.0cm

G14.0522.23  
23.0cm

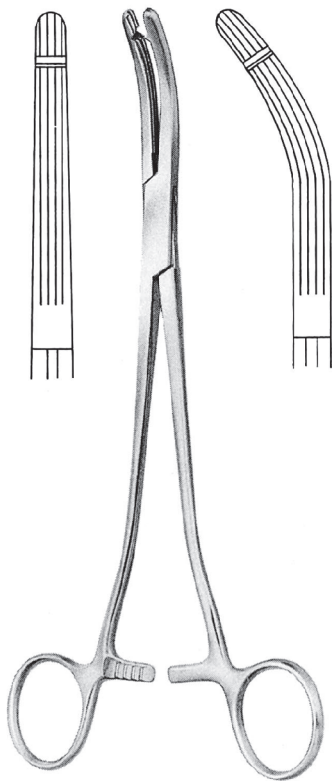

**HEANEY-BALLENTINE**  
G14.0526.21 21.0cm G14.0527.21

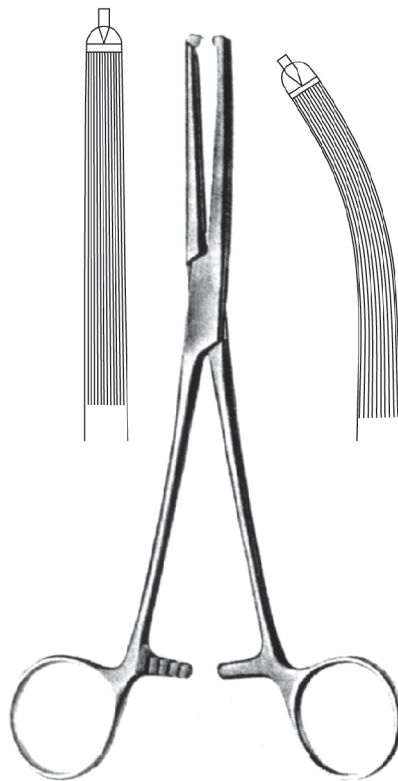

**GWILLIAM**  
G14.0530.20 20.0cm G14.0531.20

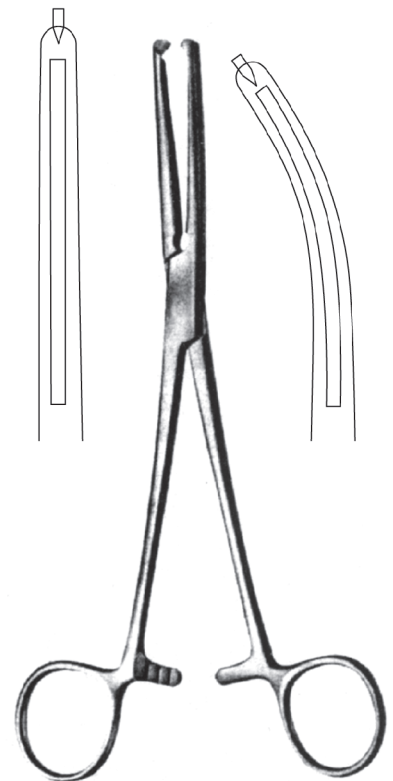

**MAINGOT**  
G14.0536.20 20.0cm G14.0537.20

G14.0537.20 **G14-029**



# G14

Hysterektomieklemmen DE

Hysterectomy Forceps EN

Pinzas Para Histerectomia ES

الملقط استئصال الرحم AR

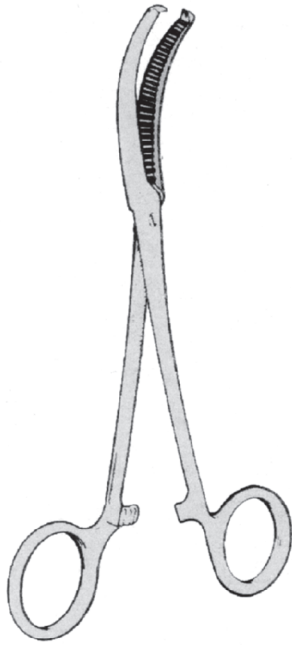

**BERKELEY**  
G14.0540.20 20.0 cm



**BERKELEY BONNEY**  
G14.0544.19 19.0 cm

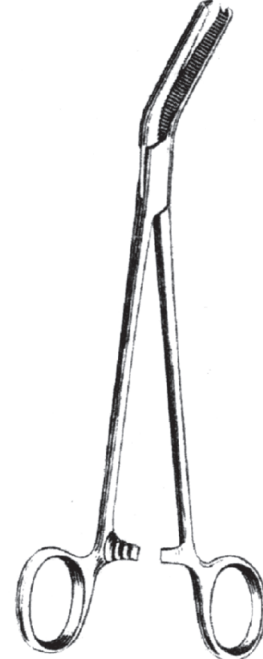

**BONNEY**  
G14.0548.20 20.5 cm

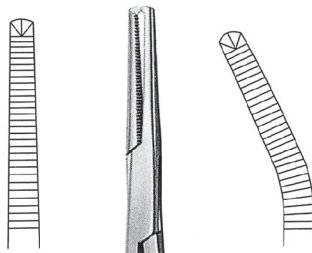

G14.0550.21

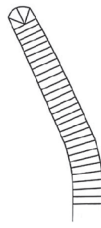

G14.0551.21

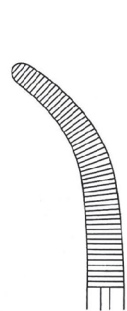

G14.0556.23  
23.0 cm

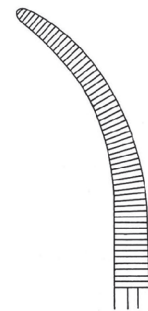

G14.0556.24  
24.0 cm

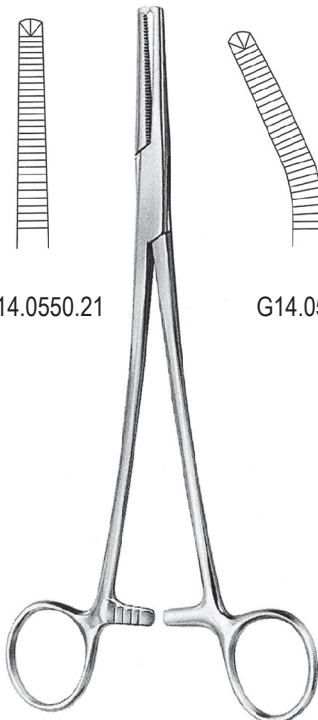

**PHANEUF**  
21.0cm

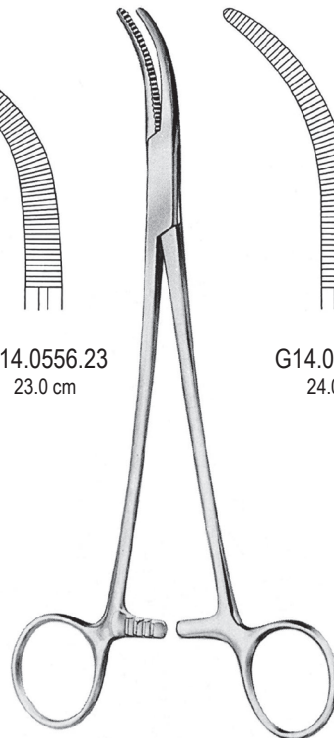

**MOYNIHAN**

G14-030 G14.0556.24



DE Klemmzangen, Hysterektomieklemmen, Vaginalklemmen  
EN Clamps-Forceps, Hysterectomy and Vaginal Forceps  
ES Pinzas-clamps, pinzas-clamps para histerectoia y vaginales  
AR الأشرطة الملقط، أو استئصال الرحم والمهبل الملقط



G14.0560.22  
22.0cm



G14.0560.23  
23.0cm



G14.0562.22  
22.0cm



G14.0562.23  
23.0cm

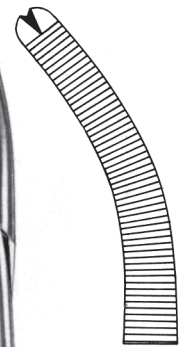

G14.0566.24  
24.0cm

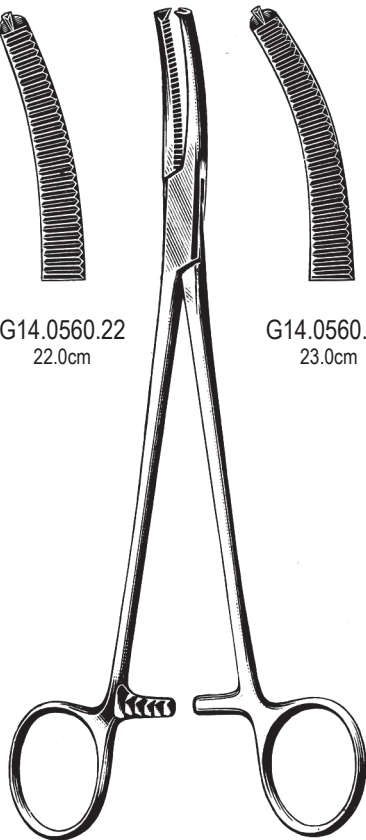

WERTHEIM

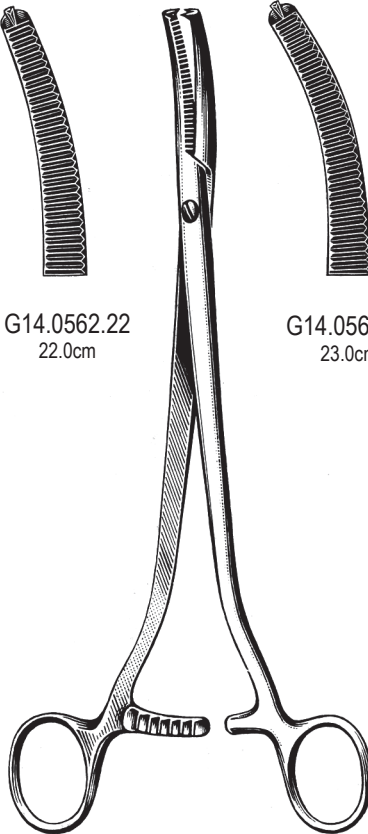

WERTHEIM



WERTHEIM





# G14

Hysterektomieklemmen DE  
Hysterectomy Forceps EN  
Pinzas Para Histerectomia ES  
الملقط استئصال الرحم AR

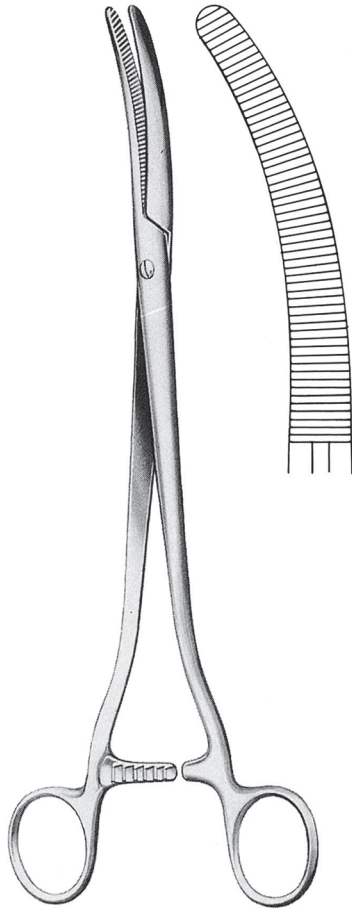

**FAURE**  
G14.0570.25 25.0cm

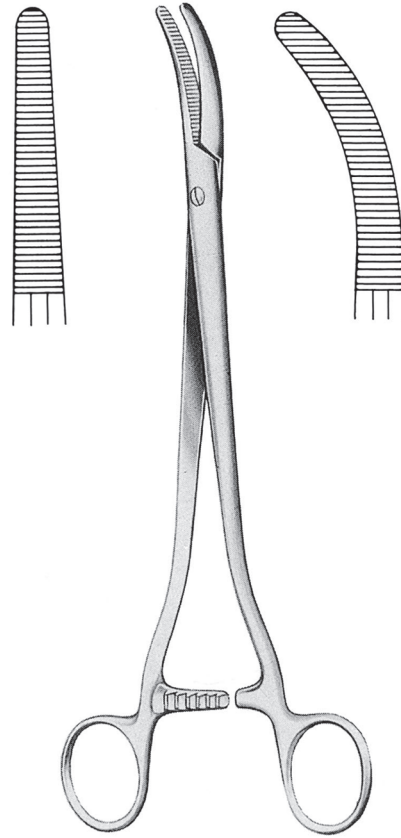

**SEGOND-LANDAU**  
G14.0576.24 24.0cm G14.0577.24

G14-032 G14.0577.24

- DE Klemmzangen, Hysterektomieklemmen, Vaginalklemmen
- EN Clamps-Forceps, Hysterectomy and Vaginal Forceps
- ES Pinzas-clamps, pinzas-clamps para histerectoia y vaginales
- AR الأشرطة الملقط، أو استئصال الرحم والمهبل الملقط

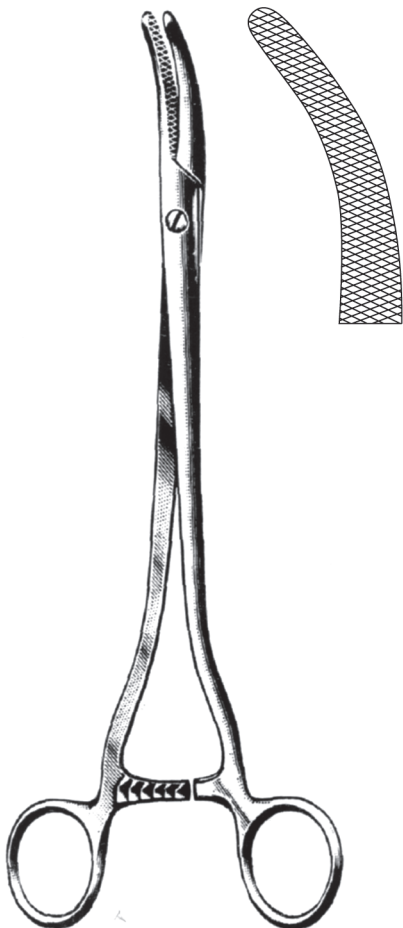

**WERTHEIM**  
G14.0580.25 25.0cm

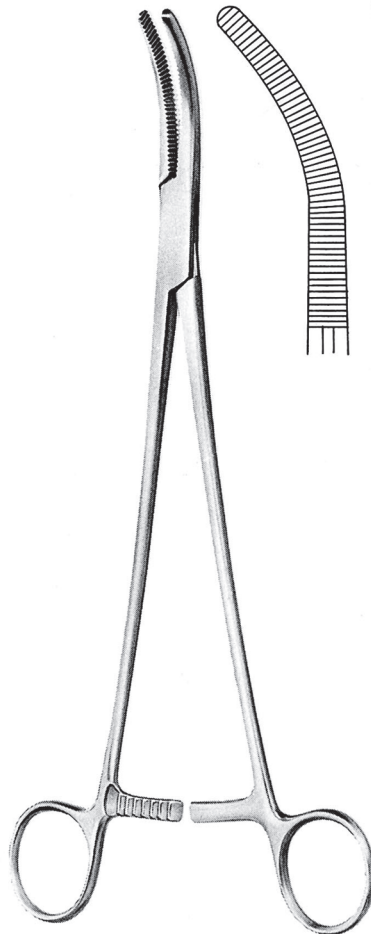

**WERTHEIM**  
G14.0582.25 25.0cm

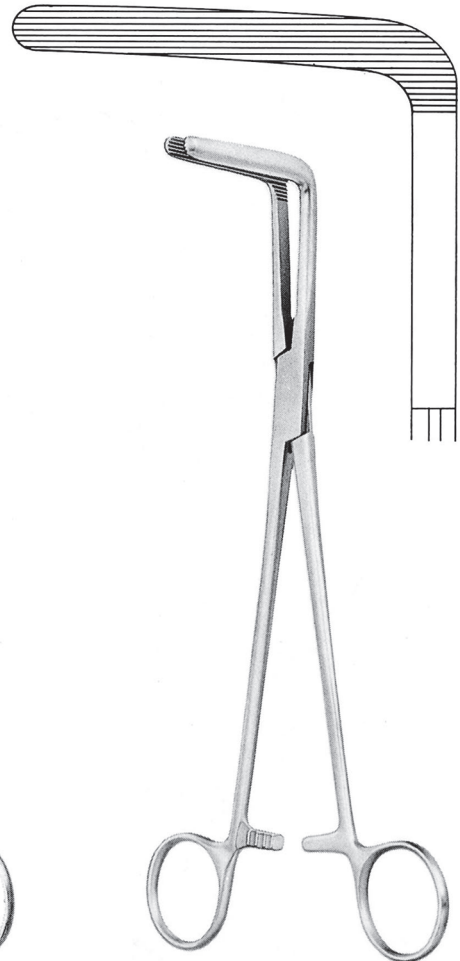

**WERTHEIM-CULLEN**  
G14.0586.21 21.5cm



# G14

Klemmzangen, Hysterektomieklemmen, Vaginalklemmen DE

Clamps-Forceps, Hysterectomy and Vaginal Forceps EN

Pinzas-clamps, pinzas-clamps para histerectoia y vaginales ES

الأشرطة الملقط، أو استئصال الرحم والمهبل الملقط AR

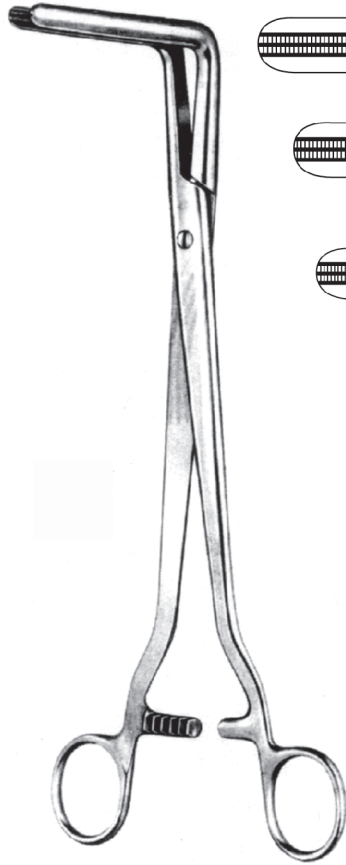

**WERTHEIM**  
24.0cm

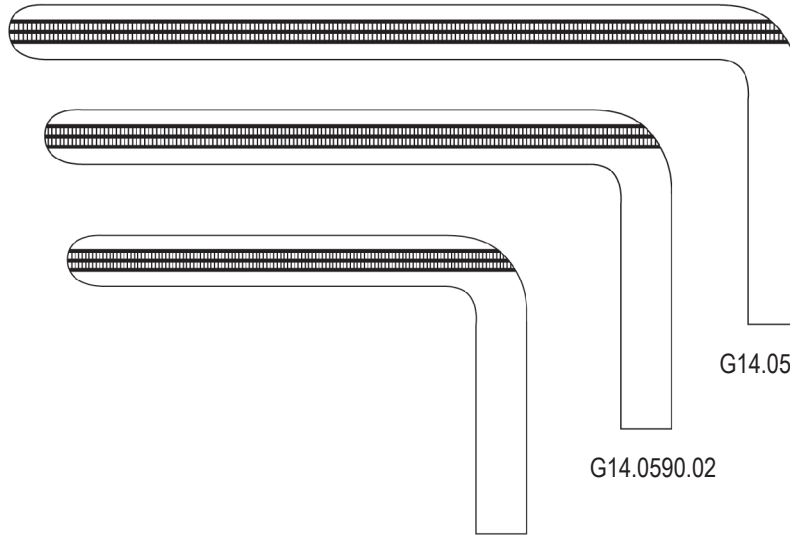

**ATRAUMA**

G14.0590.03

G14.0590.02

G14.0590.01

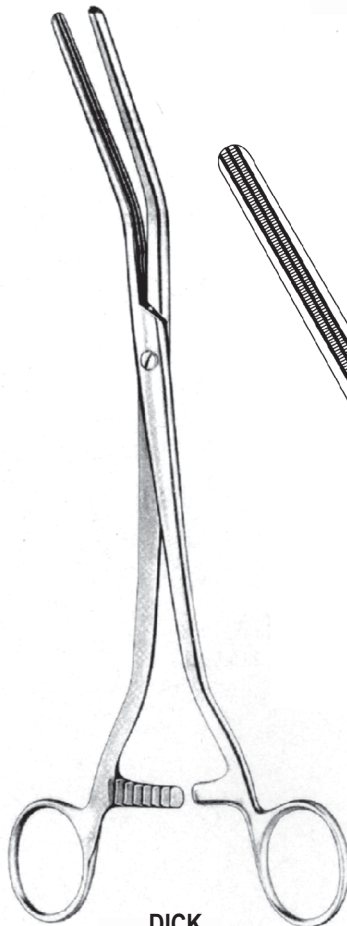

**DICK**

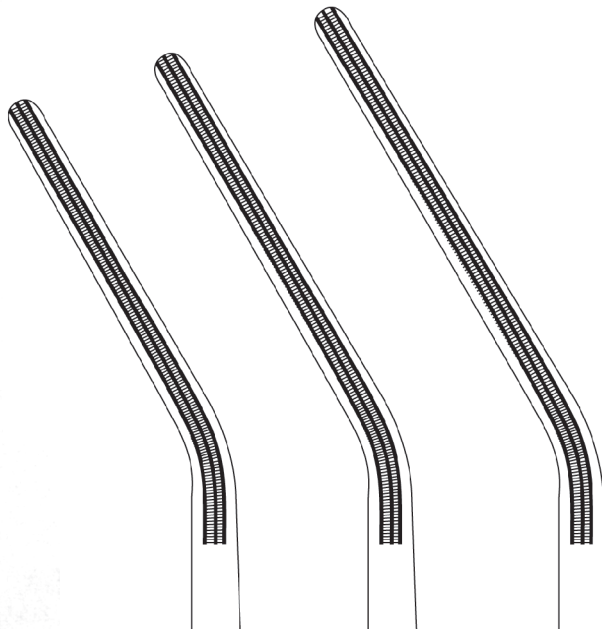

G14.0594.25  
25.0cm

G14.0594.26  
26.0cm

G14.0594.27  
27.0cm

**G14-034** G14.0594.27



DE **Hysterektomieklemmen**

EN **Hysterectomy Forceps**

ES **Pinzas-clamps para histerectomia**

AR **الملقط استئصال الرحم**

ATRAUMA



**ROGERS**



G14.0600.01  
22.0cm



G14.0600.02  
21.5cm



G14.0600.03  
21.0cm

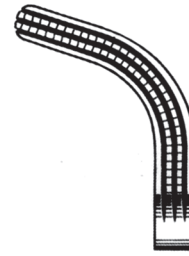

G14.0600.04  
20.5cm



G14.0602.01  
25.0cm



G14.0602.02  
25.0cm



G14.0602.03  
24.5cm



G14.0602.04  
23.0cm



# G14

Arterien, und Hamorrhoidal-Klemmen und Kopfhautklemmen DE  
 Artery Forceps, Haemorrhidal Clamps and Scalp Flap Forceps EN  
 Pinzas hemostatica, pinzas-clamps hamostaticas para pericraneo ES  
 الملقط ررف فروة الرأس و هارس الأوعية AR



**MARTEL**  
G14.0620.14 14.0cm



**PRATT**  
G14.0624.15 15.0cm

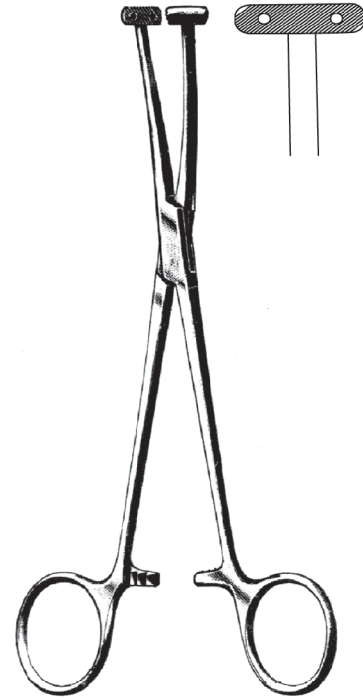

**WILLET-MARTEL**  
G14.0628.19 19.0cm

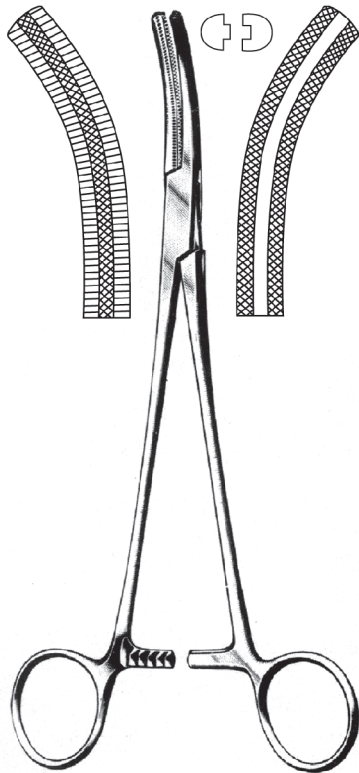

**BUIE**  
G14.0630.21 21.0cm



**FERGUSSON**

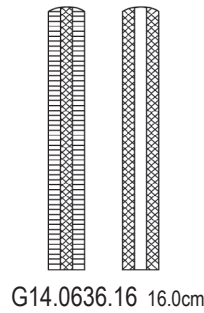

G14.0636.16 16.0cm

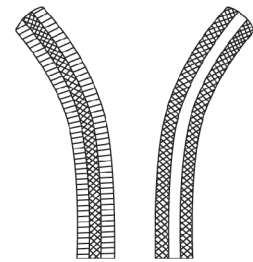

G14.0637.16 16.0cm

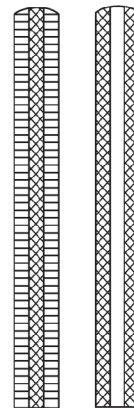

G14.0636.20 20.0cm

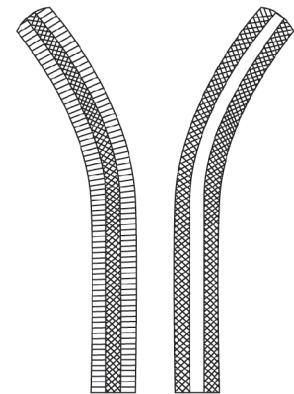

G14.0637.20 20.0cm

**G14-036** G14.0637.20



DE Arterienklemmen, Tumorfassklemmen  
 EN Artery Forcep, Tumor Seizing Forceps  
 ES Pinzas hemostaticas, pinzas para sacar tumores  
 AR الملقط الشريان والملقط الاستيلاء على الورم



**COLLIN**  
G14.0640.14 14.0cm



**PENNINGTON**  
G14.0646.15 15.5cm  
G14.0646.20 20.0cm

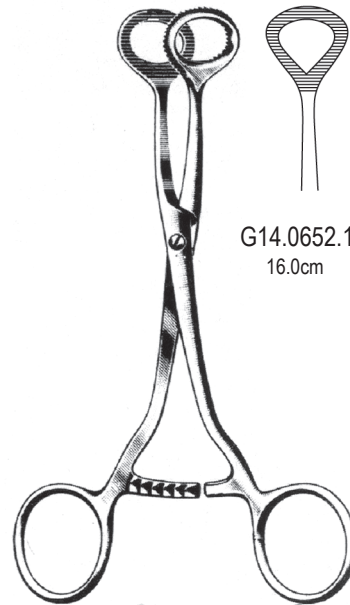

**COLLIN**  
G14.0650.16 16.0cm

G14.0652.16  
16.0cm

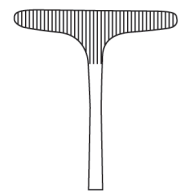

G14.0654.16  
16.0cm



G14.0656.16  
16.0cm

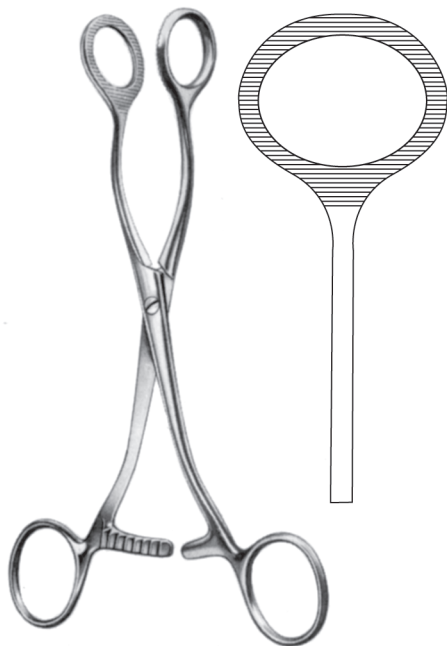

**COLLIN**  
G14.0658.16 16.5cm

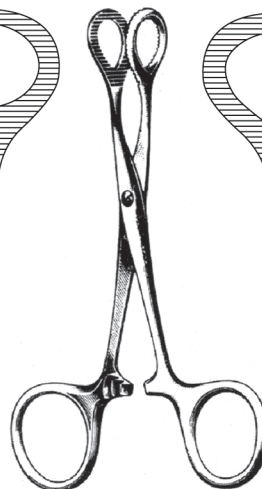
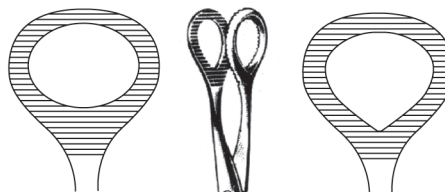

**PEAN**  
G14.0660.12 12.0cm G14.0662.12



**HOPFNER**  
G14.0666.16 16.0cm

G14.0666.16 **G14-037**



# G14

Gewebe-und Organ Faßzangen DE  
Tissue and Organ Holding Forceps EN  
Pinzas para tejidos y organos ES  
الأنسجة والجهاز الملقط القابضة AR

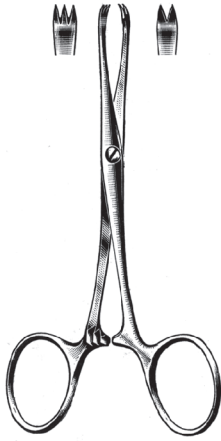

**CHAPUT**  
G14.0670.13 13.0cm

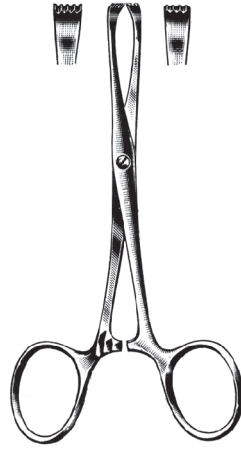

**TUFFIER**  
G14.0674.13 13.0cm

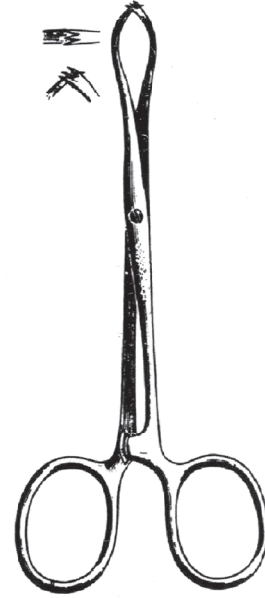

**PORRIER**  
G14.0678.12 12.5cm  
G14.0678.18 18.0cm

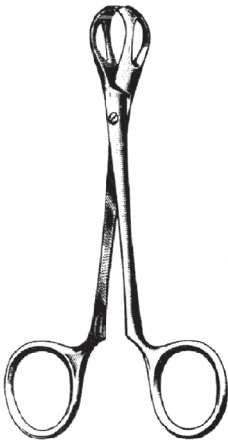

**LANE**  
G14.0680.12 12.5cm  
G14.0680.15 15.0cm  
G14.0680.19 19.5cm

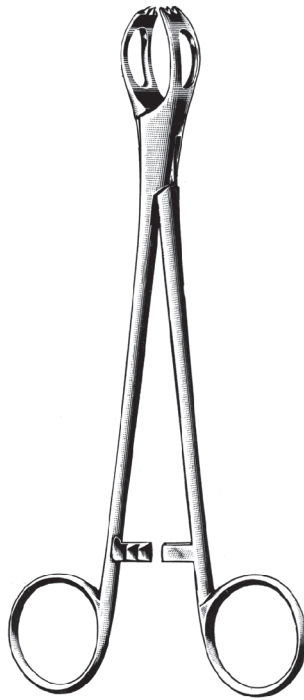

**LANE**  
G14.0682.12 12.5cm  
G14.0682.15 15.0cm  
G14.0682.20 20.0cm



**ATRAUMA**

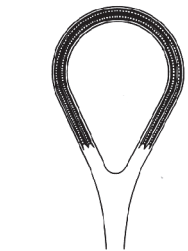

G14.0686.25 25.0cm

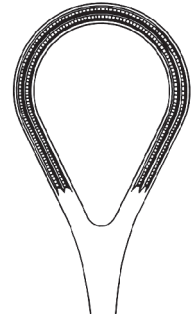

G14.0688.26 26.0cm

**G14-038** G14.0688.26



DE Schlauchklemmen  
EN Tubing Clamp  
ES Pinzas para tubos  
AR المشابك الأنابيب

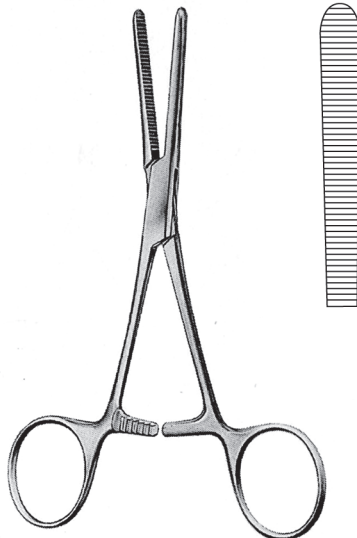

G14.0690.14 14.5cm

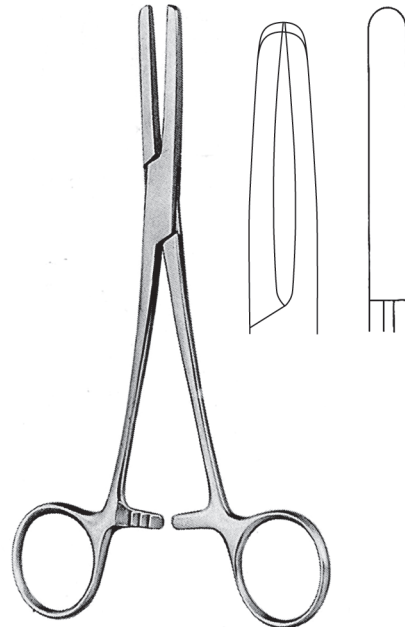

G14.0692.16 16.5cm  
G14.0692.18 18.0cm  
G14.0692.20 20.0cm

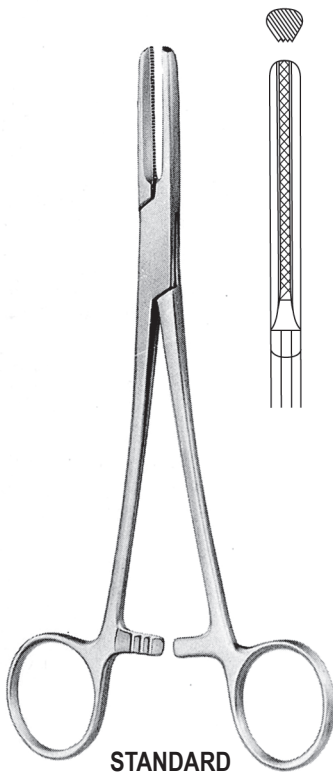

**STANDARD**  
G14.0700.15 15.0cm  
G14.0700.18 18.0cm  
G14.0700.20 20.0cm

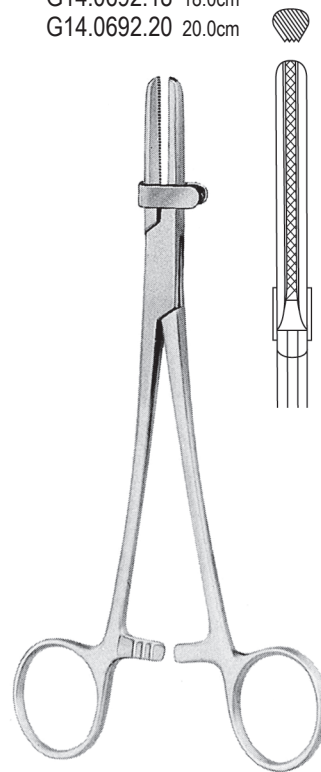

G14.0702.15 15.0cm  
G14.0702.16 16.5cm  
G14.0702.18 18.0cm  
G14.0702.20 20.0cm

G14.0702.20 **G14-039**





# G14

Tuchklemmen DE

Towel Clamps EN

Pinzas para compresas, pinzas de campo ES

ملقاط الفوط AR



**LORNA**

G14.0710.10 10.0cm  
G14.0710.13 13.0cm

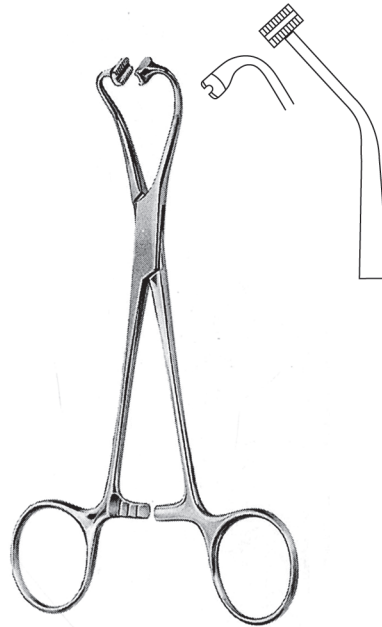

**PEERS-BERTRAM**

G14.0714.14 14.5cm

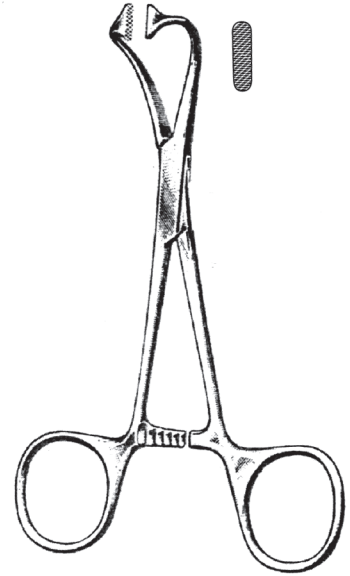

G14.0718.10 10.0cm  
G14.0718.13 13.0cm

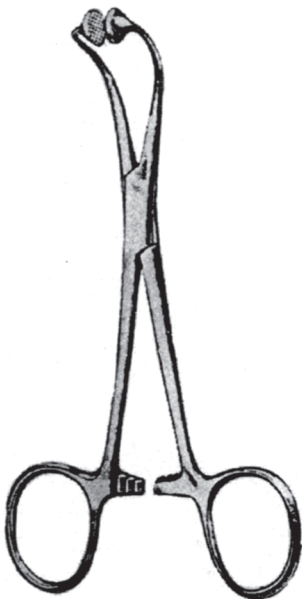

**HOFF (HOFER)**

G14.0720.10 10.0cm  
G14.0720.14 14.5cm

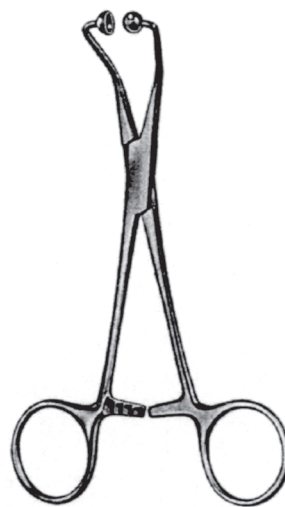

**BALL AND SOCKET**

G14.0722.13 13.0cm

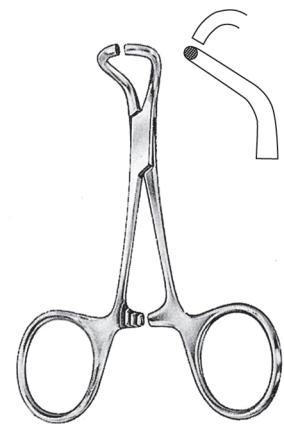

**TOHOKU**

G14.0726.10 10.0cm  
G14.0726.13 13.0cm

**G14-040** G14.0726.13



DE Tuchklemmen

EN Towel Clamps

ES Pinzas para compresas, pinzas de campo

AR ملقاط الفوط

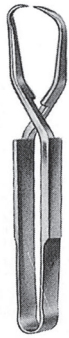

**SCHAEDEL**  
G14.0730.09 9.0cm



**ENGLISH MODEL**  
G14.0732.09 9.0cm



**JONES**  
G14.0734.05 5.0cm  
G14.0734.09 9.0cm

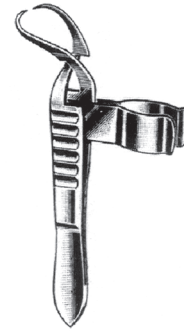

**JONES**  
G14.0736.09 9.0cm



**BACKHAUS**  
G14.0740.08 08.0cm  
G14.0740.09 09.0cm  
G14.0740.11 11.0cm  
G14.0740.13 13.0cm  
G14.0740.14 14.0cm  
G14.0740.15 15.0cm



**DELICATE**  
G14.0742.11 11.0cm  
G14.0742.13 13.0cm



G14.0746.11 11.0cm



**ROEDER**  
G14.0750.13 13.0cm  
G14.0750.15 15.0cm



# G14

Tuchklemmen DE

Towel Clamps EN

Pinzas para compresas, pinzas de campo ES

ملقاط الفوط AR



**ROBIN**  
G14.0754.13 13.5cm



**ROBIN**  
G14.0756.13 13.5cm



**BERNHARD**  
G14.0758.16 16.5cm

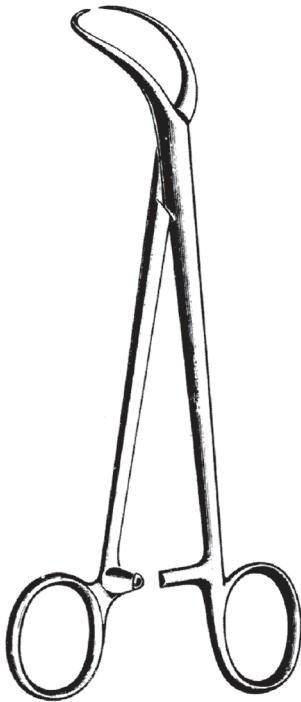

**MAYO**  
G14.0760.14 14.0cm

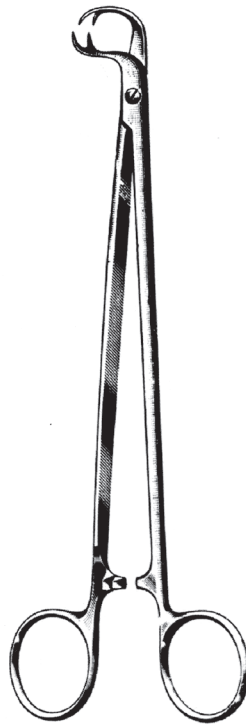

**MOYNIHAN**  
G14.0762.19 19.0cm

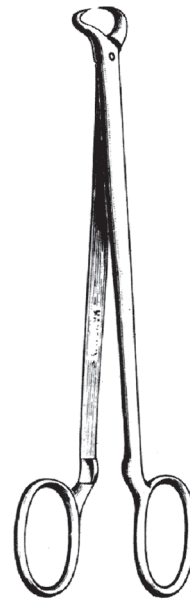

**MOYNIHAN**  
G14.0764.18 18.0cm



**DOYEN**  
G14.0766.18 18.0cm

**G14-042** G14.0766.18

