

- **Medical Equipment**
- **Surgical instruments**

Anatomische und Chirurgische Pinzetten

DE	Anatomische und Chirurgische Pinzetten
EN	Dressing and Tissue Forceps
ES	Pinzas de diseccion con dientes
AR	الملقط الضماد والنسيج

G12

PAGE 001 to 016



DE Anatomische Pinzetten
EN Dressing Forceps
ES Pinzas de diseccion
AR الملقط الضماد



STANDARD



STANDARD

G12.0010.10	10.5cm
G12.0010.11	11.5cm
G12.0010.13	13.0cm
G12.0010.14	14.5cm
G12.0010.16	16.0cm
G12.0010.18	18.0cm
G12.0010.20	20.0cm
G12.0010.23	23.0cm
G12.0010.25	25.0cm
G12.0010.30	30.0cm



NARROW

G12.0012.10	10.5cm
G12.0012.11	11.5cm
G12.0012.13	13.0cm
G12.0012.14	14.5cm
G12.0012.16	16.0cm
G12.0012.18	18.0cm
G12.0012.20	20.0cm
G12.0012.23	23.0cm
G12.0012.25	25.0cm
G12.0012.30	30.0cm



USA MODEL



G12.0016.12	12.0cm
G12.0016.13	13.0cm
G12.0016.14	14.5cm
G12.0016.15	15.0cm
G12.0016.18	18.0cm
G12.0016.21	21.0cm
G12.0016.25	25.0cm
G12.0016.31	31.0cm

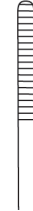

G12.0018.12	12.0cm
G12.0018.13	13.0cm
G12.0018.14	14.5cm
G12.0018.15	15.0cm
G12.0018.18	18.0cm
G12.0018.21	21.0cm
G12.0018.25	25.0cm



G12

Anatomische Pinzetten DE
Dressing Forceps EN
Pinzas de diseccion ES
الملقط الضماد AR



STILLE
G12.0022.15
15.0cm

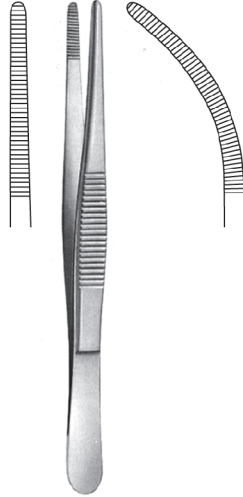

OCHSNER
G12.0028.14
14.0cm

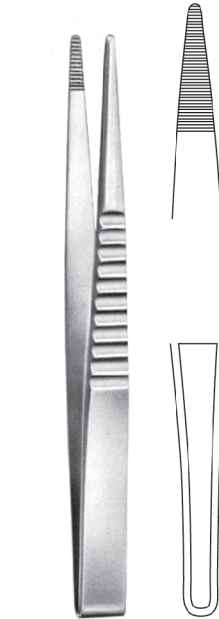

G12.0032.12 12.0cm
G12.0032.15 15.0cm
G12.0032.18 18.0cm
G12.0032.20 20.0cm
G12.0032.25 25.0cm

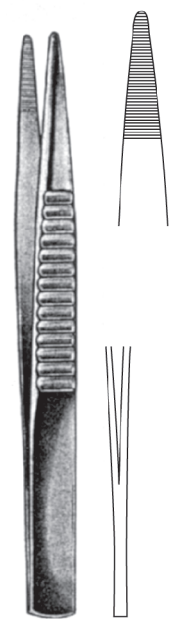

G12.0038.12 12.0cm
G12.0038.15 15.0cm
G12.0038.18 18.0cm
G12.0038.20 20.0cm
G12.0038.25 25.0cm

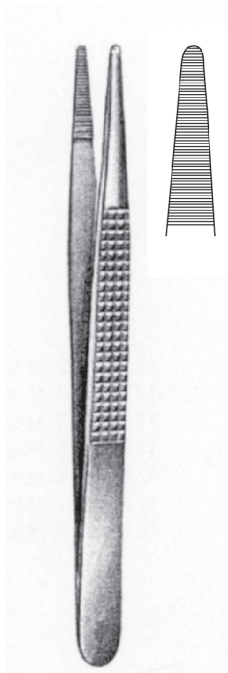

BONNEY
G12.0046.17
17.5cm



RAMSEY
G12.0050.18
18.0cm

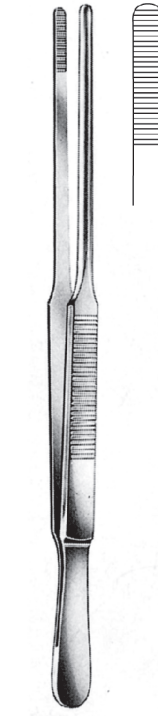

DUEHRSSSEN
G12.0054.20
20.0cm



WANGENSTEEN
G12.0058.23
23.0cm

G12-002 G12.0058.23



DE Anatomische Pinzetten
EN Dressing Forceps
ES Pinzas de diseccion
AR الملقط الضماد

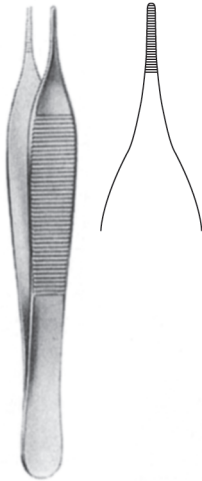

ADSON

G12.0066.12 12.0cm
G12.0066.15 15.0cm
G12.0066.19 19.0cm



McINDOE

G12.0070.15 15.0cm



SEMKEN

G12.0076.12 12.0cm G12.0077.12
G12.0076.15 15.0cm G12.0077.15



CUSHING

G12.0080.17 17.0cm G12.0081.17



POTTS.SMITH

G12.0084.18 18.0cm
G12.0084.21 21.0cm
G12.0084.25 25.0cm
G12.0084.30 30.0cm



WAUGH

G12.0088.15 15.0cm
G12.0088.18 18.0cm
G12.0088.20 20.0cm



BROPHY

G12.0092.20 20.0cm G12.0093.20

G12.0093.20 **G12-003**



G12

Anatomische Pinzetten	DE
Dressing Forceps	EN
Pinzas de diseccion	ES
الملقط الضماد	AR

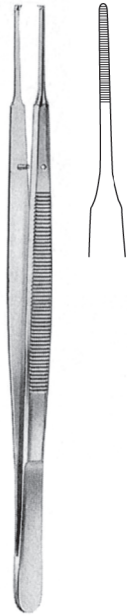

GERALD
G12.0094.18 18.0cm

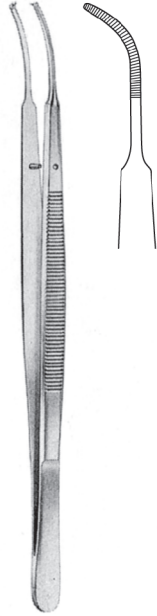

GERALD
G12.0095.18 18.0cm



GERALD
G12.0098.18 18.0cm



TAYLOR
G12.0100.17 17.5cm
G12.0101.17 17.5cm

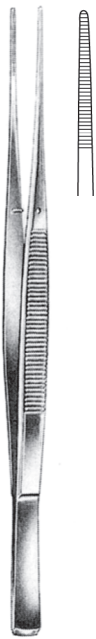

TAYLOR
G12.0102.17
18.5cm



TAYLOR
G12.0104.17
17.5cm

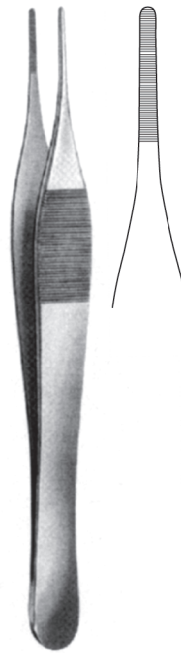

JEFFERSON
G12.0106.18
18.0cm, 180mm



ADSON
G12.0108.18
18.0cm, 180mm

G12-004 G12.0108.18



DE Chirurgische Pinzetten

EN Tissue Forceps

ES Pinzas de diseccion con dientes

AR الملقط النسيج



STANDARD

	SLENDER 1:2	DELICATE 1:2	REGULAR 1:2	2:3	3:4	4:5
10.0cm			G12.0114.10	G12.0116.10	G12.0118.10	G12.0120.10
11.0cm	G12.0110.11		G12.0114.11	G12.0116.11	G12.0118.11	G12.0120.11
13.0cm	G12.0110.13	G12.0112.13	G12.0114.13	G12.0116.13	G12.0118.13	G12.0120.13
14.0cm	G12.0110.14	G12.0112.14	G12.0114.14	G12.0116.14	G12.0118.14	G12.0120.14
16.0cm	G12.0110.16	G12.0112.16	G12.0114.16	G12.0116.16	G12.0118.16	G12.0120.16
18.0cm	G12.0110.18	G12.0112.18	G12.0114.18	G12.0116.18	G12.0118.18	G12.0120.18
20.0cm	G12.0110.20	G12.0112.20	G12.0114.20	G12.0116.20	G12.0118.20	G12.0120.20
23.0cm			G12.0114.23			
25.0cm			G12.0114.25	G12.0116.25	G12.0118.25	G12.0120.25
30.0cm			G12.0114.30	G12.0116.30	G12.0118.30	G12.0120.30



USA MODEL

12.0cm	G12.0124.12			
13.0cm	G12.0124.13	G12.0126.13	G12.0128.13	G12.0130.13
14.0cm	G12.0124.14	G12.0126.14	G12.0128.14	G12.0130.14
15.0cm	G12.0124.15	G12.0126.15	G12.0128.15	G12.0130.15
18.0cm	G12.0124.18			
21.0cm	G12.0124.21			
25.0cm	G12.0124.25			
31.0cm	G12.0124.31			





1:2

STILLE

G12.0134.15 15.0cm
G12.0136.15 15.0cm



2:3

TREVES

G12.0140.12 12.5cm
G12.0140.15 15.0cm
G12.0140.18 18.0cm
G12.0140.20 20.0cm
G12.0140.25 25.0cm



1:2

ADLERKREUZ

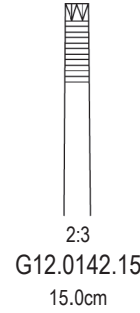

2:3
G12.0142.15
15.0cm

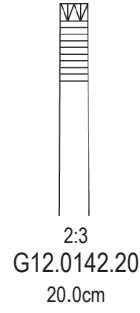

2:3
G12.0142.20
20.0cm

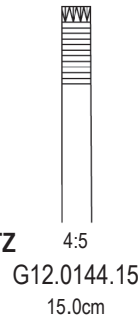

4:5
G12.0144.15
15.0cm

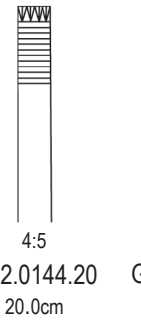

4:5
G12.0144.20
20.0cm

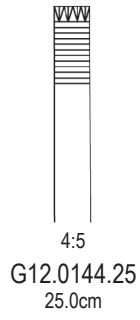

4:5
G12.0144.25
25.0cm



STILLE-BARRAYA

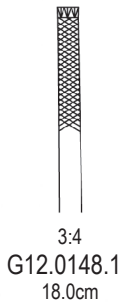

3:4
G12.0148.18
18.0cm

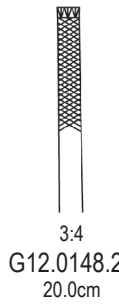

3:4
G12.0148.20
20.0cm

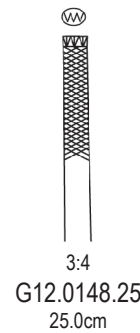

3:4
G12.0148.25
25.0cm



1:2



BROPHY

G12.0152.20 20.0cm G12.0153.20

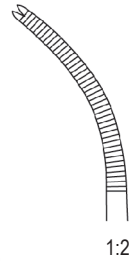

1:2



1:2

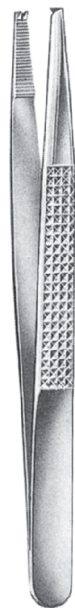

BONNEY

G12.0156.18 18.0cm G12.0158.18



2:3

DE Chirurgische Pinzetten

EN Tissue Forceps

ES Pinzas de diseccion con dientes

AR الملقط النسيج



ADSON
G12.0160.18 18.0cm

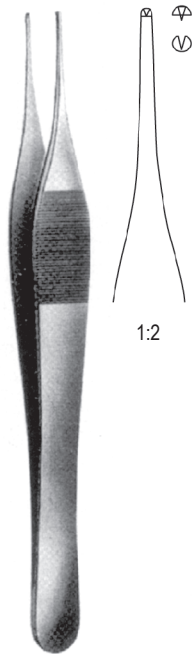

JEFFERSON
G12.0162.18 18.0cm

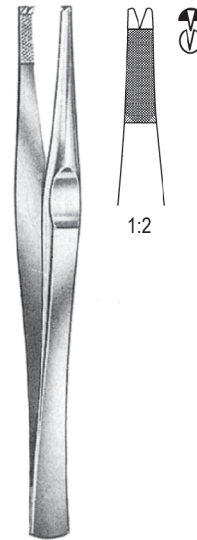

LANES
G12.0166.12 12.5cm
G12.0166.15 15.0cm
G12.0166.18 18.0cm
G12.0166.20 20.0cm

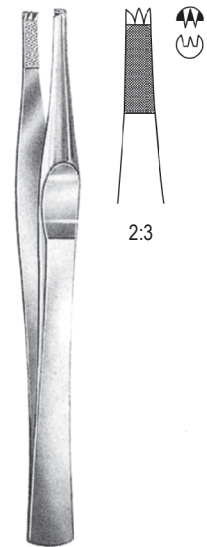

LANES
G12.0168.12 12.5cm
G12.0168.15 15.5cm
G12.0168.18 18.0cm
G12.0168.20 20.0cm

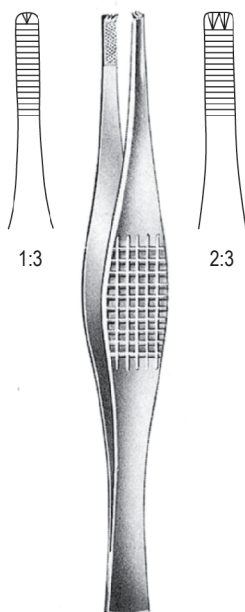

FERRIS-SMITH
G12.0172.18 18.0cm G12.0174.18

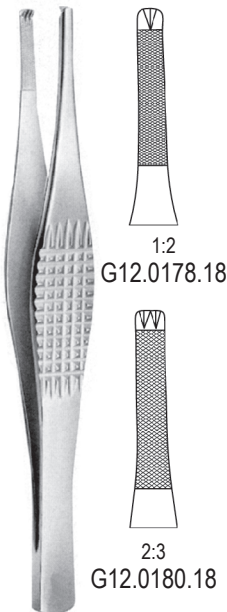

RAMSAY
18.0cm

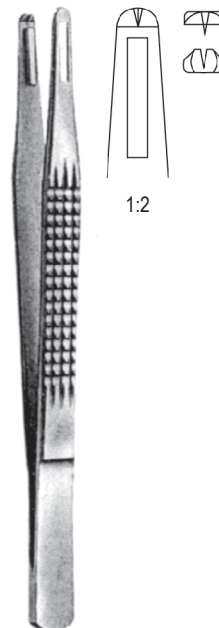

CHARNLEY
G12.0182.18 18.0cm



JEANS
G12.0188.14 14.5cm
G12.0188.17 17.5cm

G12.0188.17 **G12-007**



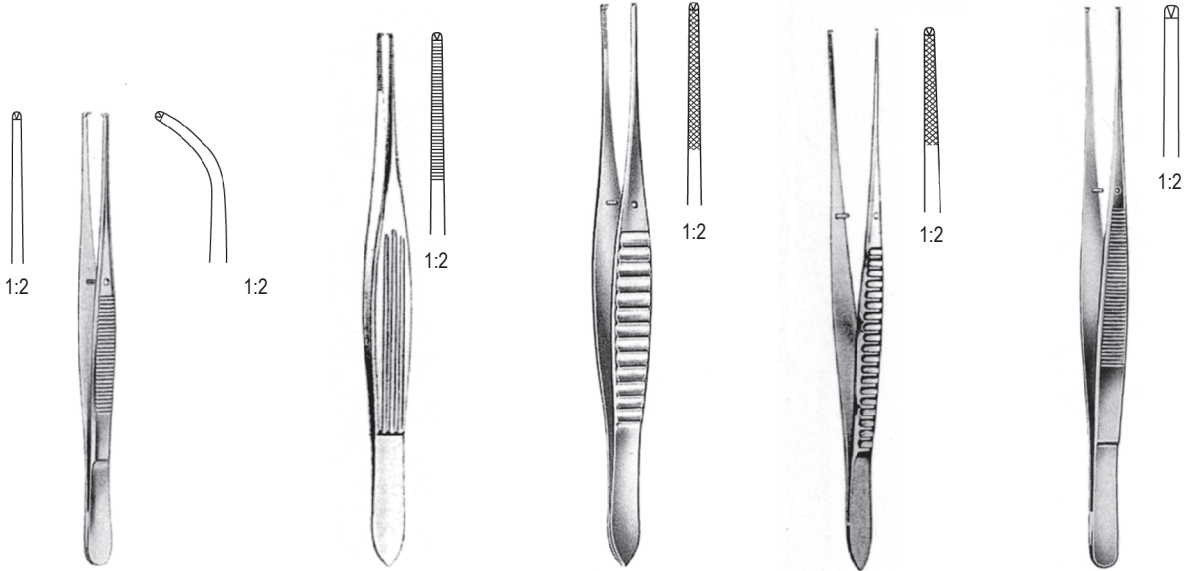

SEMKEN
G12.0196.12 12.5cm G12.0197.12
G12.0196.15 15.0cm G12.0197.15

McINDOE
G12.0200.15 15.0cm

GILLIES
G12.0204.15 15.0cm

WAUGH
G12.0208.15 15.0cm
G12.0208.18 18.0cm
G12.0208.20 20.0cm

POTTS.SMITH
G12.0212.18 18.0cm
G12.0212.21 21.0cm
G12.0212.25 25.0cm
G12.0212.30 30.0cm

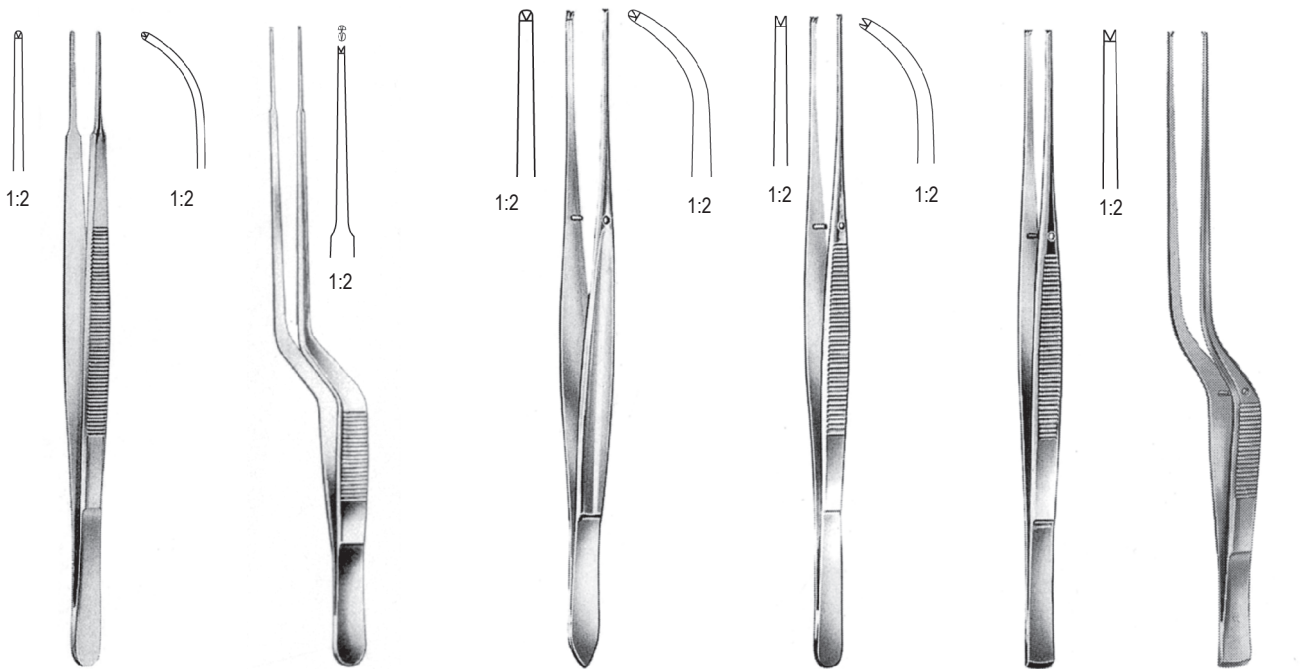

GERALD
G12.0218.18 18.0cm
G12.0219.18 18.0cm

GERALD
G12.0220.18 18.0cm

CUSHING
G12.0222.17 17.5cm
G12.0223.17 17.5cm

TAYLOR
G12.0228.17 17.5cm
G12.0229.17 17.5cm

TAYLOR
G12.0232.17 17.5cm

TAYLOR
G12.0234.17 17.5cm

G12-008 G12.0234.17



DE Chirurgische Pinzetten

EN Tissue Forceps

ES Pinzas de diseccion con dientes

AR الملقط النسيج

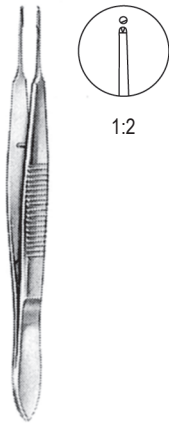

G12.0240.11
11.0cm

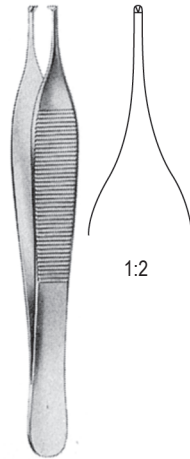

ADSON
G12.0246.12 12.0cm
G12.0246.15 15.0cm

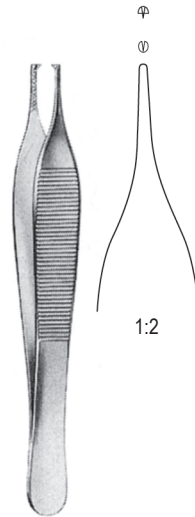

ADSON
G12.0250.12 12.0cm

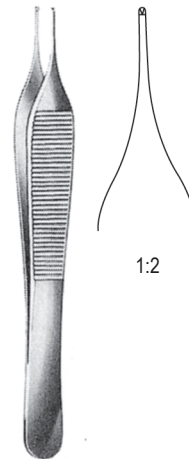

MICRO-ADSON
G12.0254.12 12.0cm

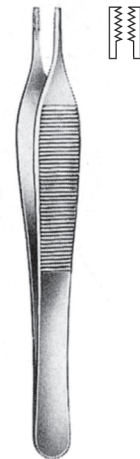

ADSON-BROWN
G12.0258.12 12.0cm

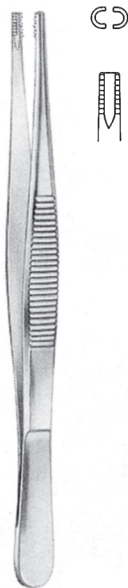

BROWN
G12.0262.15 15.0cm
G12.0262.20 20.0cm
G12.0262.25 25.0cm



GRAEFE
G12.0266.10 10.0cm

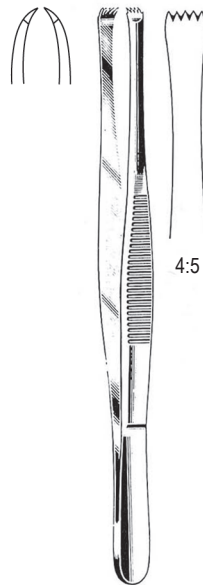

STONE
G12.0270.15 15.0cm

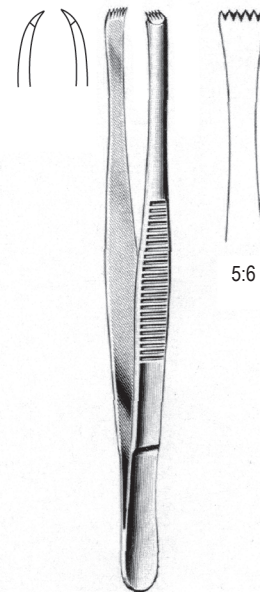

LERCHE
G12.0274.15 15.0cm

G12.0274.15 **G12-009**



G12

Chirurgische, Fassspinzetten DE

Tissue, Tumor Forceps EN

Pinzas, para coger diseccion con dientes ES

الملقط النسيج AR



G12.0280.14
14.5cm



G12.0280.16
16.0cm



G12.0280.20
20.0cm



G12.0284.15
15.0cm



G12.0284.20
20.0cm



G12.0284.25
25.0cm



MAYO RUSS
G12.0288.23 23.0cm



G12.0292.03
3mm Ø



G12.0292.05
5mm Ø



G12.0294.03G
3mm Ø



12.0294.05
5mm Ø



G12.0296.03
3mm Ø



G12.0296.05
5mm Ø

YASARGIL
22.0cm

YASARGIL
22.0cm

HEIFETZ
22.0cm

G12-010 G12.0296.05



DE Chirurgische und Mikro-Pinzetten, feine modelle
 EN Tissue and Micro forceps, fine patterns
 ES De diseccion con dientes micro-pinzas, modelos finos
 AR الإنسجة والملقط الصغرى

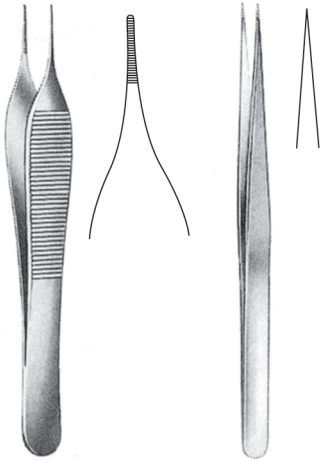

MICRO ADSON
 G12.0302.12 12.0cm G12.0306.12 12.0cm
 G12.0306.16 16.0cm

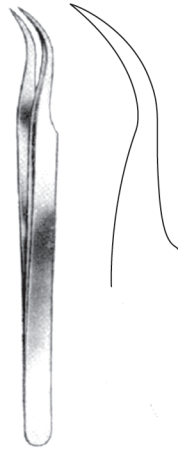

G12.0308.12 12.0cm
 G12.0308.16 16.0cm

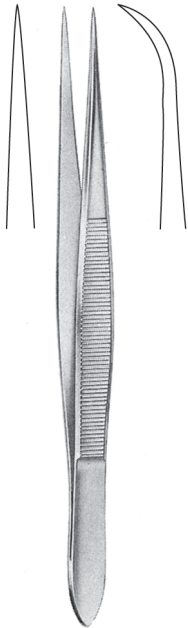

G12.0318.09 09.0cm G12.0319.09
 G12.0318.10 10.5cm G12.0319.10
 G12.0318.11 11.5cm G12.0319.11
 G12.0318.12 12.0cm G12.0319.12

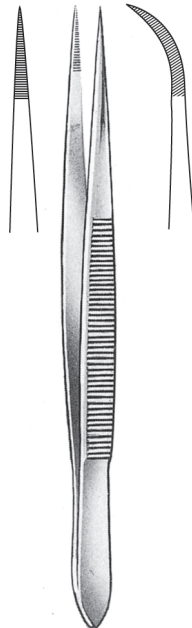

12.0320.09 09.0cm 12.0321.09
 12.0320.10 10.5cm 12.0321.10
 12.0320.11 11.5cm 12.0321.11
 12.0320.12 12.0cm 12.0321.12

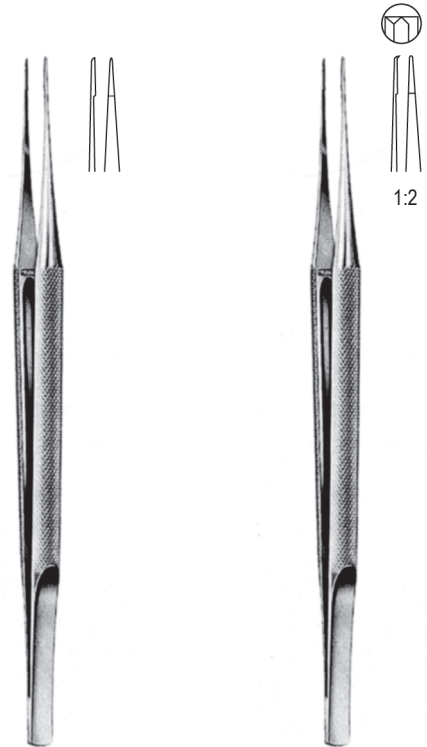

GOMEL
 G12.0326.18 18.0cm G12.0328.18



G12

Mikro-Pinzetten DE

Micro Forceps EN

Micro-pinzas ES

الملقط الصغرى AR

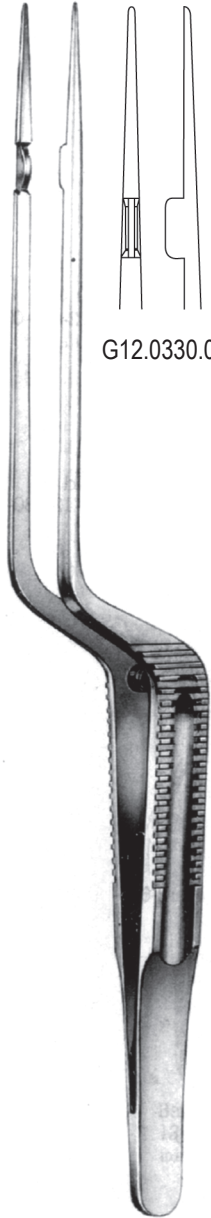

G12.0330.01

22.5cm

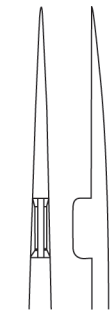

G12.0330.02



G12.0332.01

G12.0332.03

18.5cm

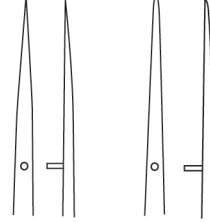

G12.0332.02

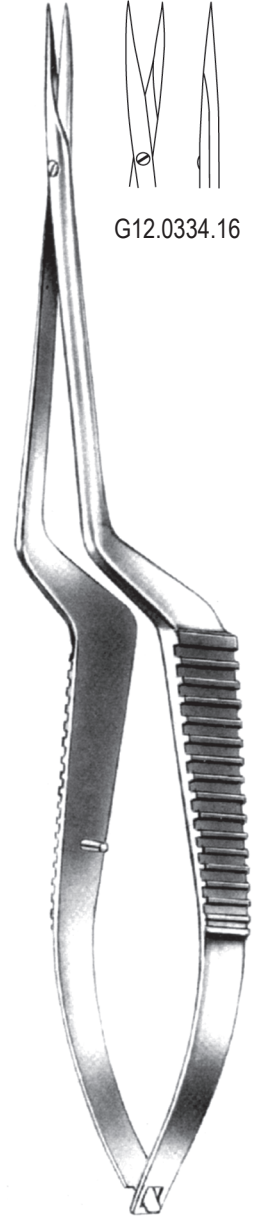

G12.0334.16

15.5cm

G12-012 G12.0334.16



DE **Faßpinzetten**
 EN **Grasping Forceps**
 ES **Pinzas para coger**
 AR **الملقط استيعاب**

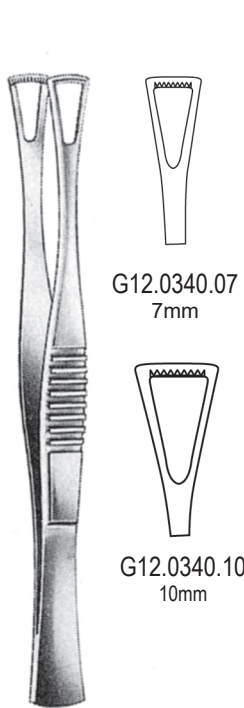

G12.0340.07
7mm

G12.0340.10
10mm

DUVAL
14.5cm



SINGLEY-TUTTLE
G12.0356.23 23.0cm

COLLIN-DUVAL
20.0cm

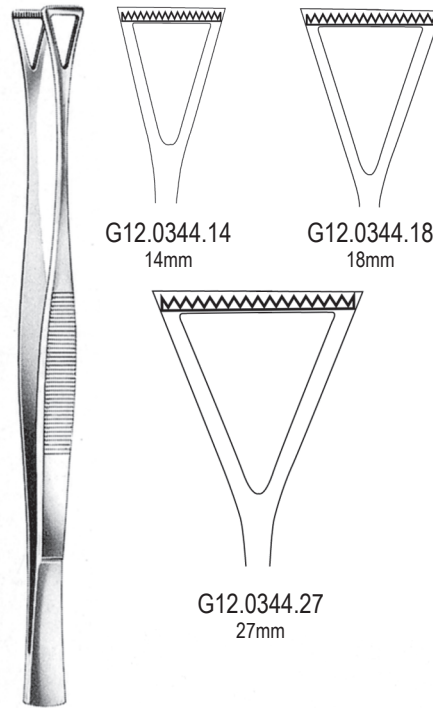

G12.0344.14
14mm

G12.0344.18
18mm

G12.0344.27
27mm



NELSON
G12.0360.23 23.0cm

HEPP/SCHIEDL
G12.0350.18 18.0cm

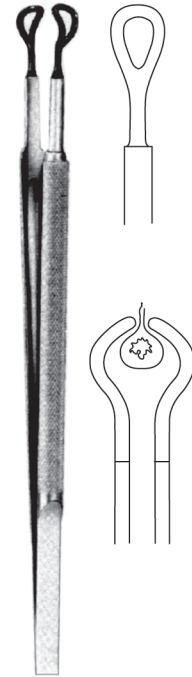

G12.0364.21
21.0cm

G12.0364.21 **G12-013**



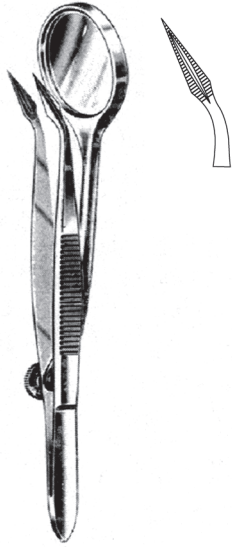

G12.0370.12
12.0cm

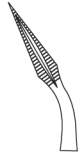

FEILCHENFELD



G12.0376.07
7.5cm



G12.0376.09
9.0cm

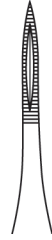

G12.0376.11
11.5cm



G12.0380.12
12.5cm

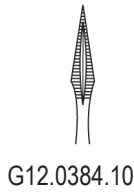

G12.0384.10



HUNTER
10.5cm

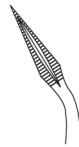

G12.0385.10



G12.0390.10



WALTER-CARMALT
10.5cm

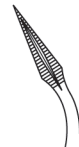

G12.0391.10



DE Spitter-Pinzetten
EN Splinter Forceps
ES Pinzas para espinas
AR الملقط الجبيرة



PEET
G12.0396.11 11.5cm

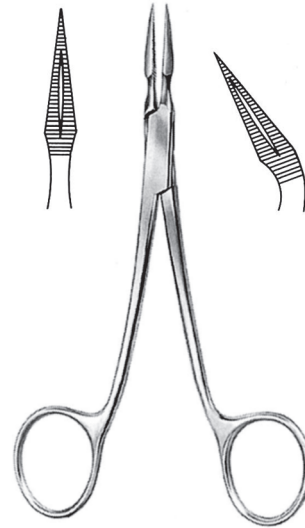

ARTHUR
G12.0400.14 14.0cm G12.0401.14

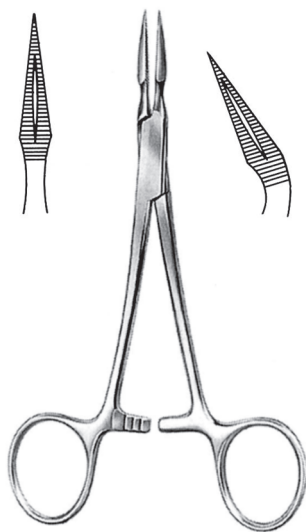

STIEGLITZ
G12.0406.13 13.5cm G12.0407.13

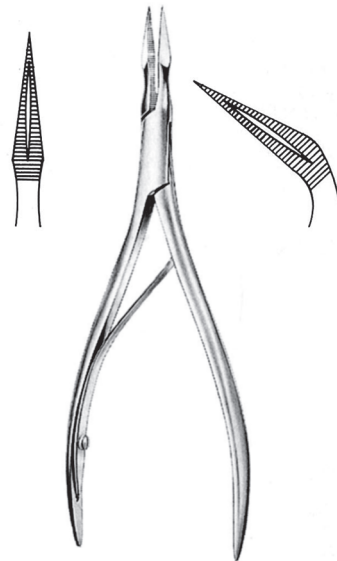

RALK
G12.0412.15 15.0cm G12.0413.15

G12.0413.15 **G12-015**



Cillenpinzetten DE

Cilia Forceps EN

Pinzas depilatorias ES

أهداب الملقط AR

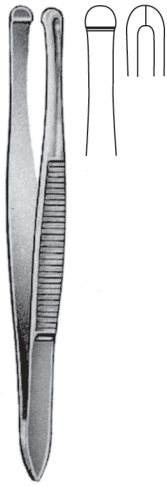

BEER
G12.0430.09 9.0cm



LITTAUER
G12.0434.08 8.5cm



G12.0438.09 9.0cm

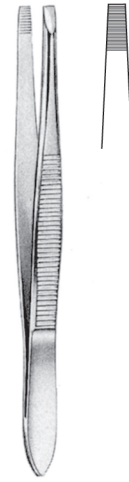

DOUGLAS
G12.0442.09 9.0cm



DOUGLAS
G12.0448.09 9.0cm



BARRAQUER
G12.0454.10 10.5cm



GRADLE
G12.0460.09 9.5cm



HENRY
G12.0466.12 12.0cm

G12-016 G12.0466.12

