

- **Medical Equipment**
- **Surgical instruments**

## Trokare und Saugrohre

DE	Trokare und Saugrohre
EN	Trocars and Suction Tubes
ES	Trócares y tubos de aspiración
AR	مبذلة وشفط أنابيب

**G06**

PAGE 001 to 017



DE Trokare  
EN Trocars  
ES Trócares  
AR مبزلة

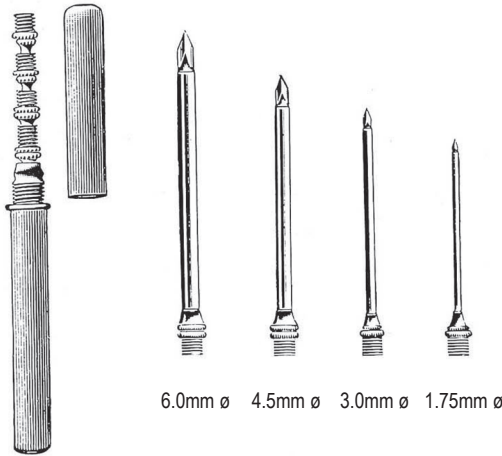

6.0mm Ø 4.5mm Ø 3.0mm Ø 1.75mm Ø

**UNIVERSAL**

G06.0010.03 Set of 3 pieces  
G06.0010.04 Set of 4 pieces

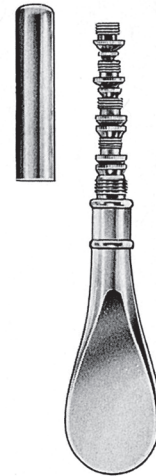

**UNIVERSAL**

G06.0016.03 Set of 3 pieces  
G06.0016.04 Set of 4 pieces



**HYDROCELE**

12.0cm  
G06.0022.08 8 FG Ø  
G06.0022.09 9 FG Ø  
G06.0022.10 10 FG Ø



**ASCITES**

15.0cm  
G06.0028.16 16 FG Ø  
G06.0028.21 21 FG Ø



**EXPLORING**

G06.0034.08 8 FG Ø

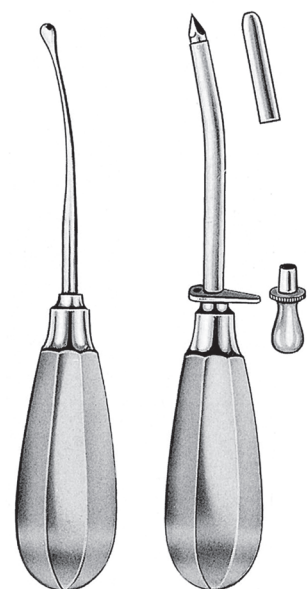

**KRAUSE**

G06.0040.30 3.0mm Ø  
G06.0040.40 4.0mm Ø  
G06.0040.50 5.0mm Ø  
G06.0040.55 5.5mm Ø

G06.0040.55 **G06-001**



# G06

Trokare DE

Trocars EN

Trócares ES

مبزة AR

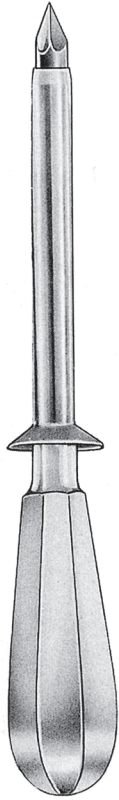

**NELSON**  
21.0cm



1

G06.0048.25 25 FG



2

G06.0048.30 30 FG



3

G06.0048.33 33 FG

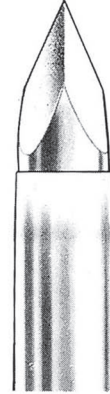

4

G06.0048.35 35 FG

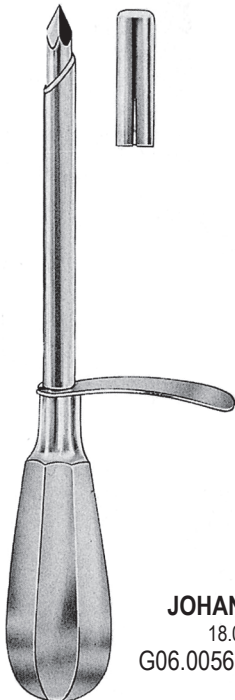

**JOHANSSON**  
18.0cm  
G06.0056.90 9mm Ø

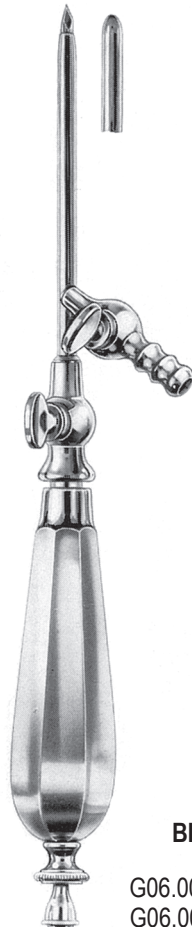

**BILLROTH**  
24.0cm  
G06.0060.50 5mm Ø  
G06.0060.60 6mm Ø

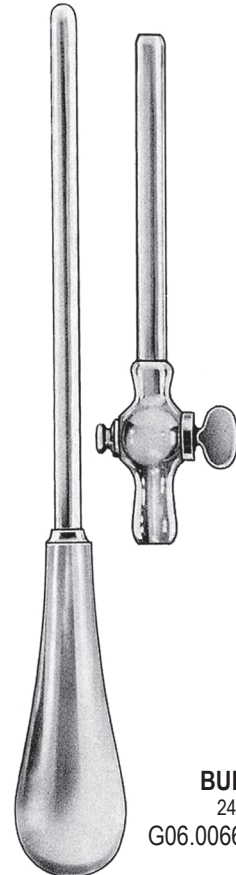
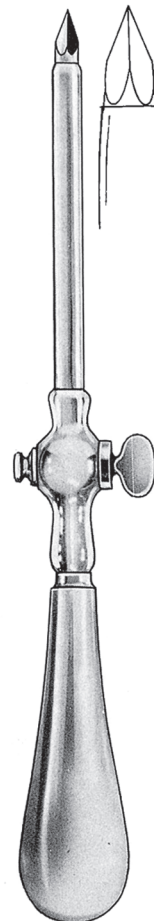

**BUELAU**  
24.0cm  
G06.0066.80 8mm Ø

**G06-002** G06.0066.80



DE Trokare  
EN Trocars  
ES Trócares  
AR مبرلة



**FLEURANT**  
23.0cm  
G06.0074.50 5mm Ø



**FLEURANT**  
23.0cm  
G06.0080.50 5mm Ø



**STANDARD 11.0cm**  
G06.0090.30 3.0mm Ø  
G06.0090.35 3.5mm Ø  
G06.0090.40 4.0mm Ø  
G06.0090.45 4.5mm Ø  
G06.0090.50 5.0mm Ø  
G06.0090.55 5.5mm Ø  
G06.0090.60 6.0mm Ø

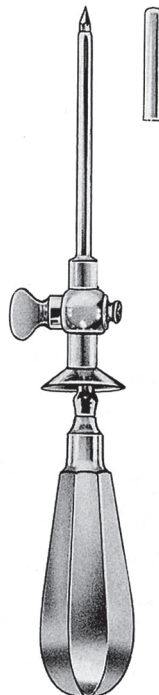

**STANDARD 12.0cm**  
G06.0094.30 3.0mm Ø  
G06.0094.35 3.5mm Ø  
G06.0094.40 4.0mm Ø  
G06.0094.45 4.5mm Ø  
G06.0094.50 5.0mm Ø  
G06.0094.55 5.5mm Ø  
G06.0094.60 6.0mm Ø

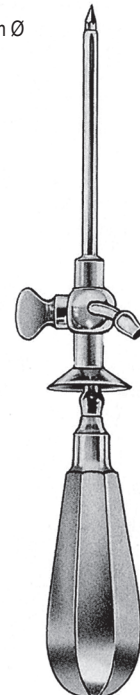

**STANDARD 12.0cm**  
G06.0098.30 3.0mm Ø  
G06.0098.35 3.5mm Ø  
G06.0098.40 4.0mm Ø  
G06.0098.45 4.5mm Ø  
G06.0098.50 5.0mm Ø  
G06.0098.55 5.5mm Ø  
G06.0098.60 6.0mm Ø

G06.0098.60 **G06-003**





# G06

Trokare DE

Trocars EN

Trócares ES

مبيلة AR

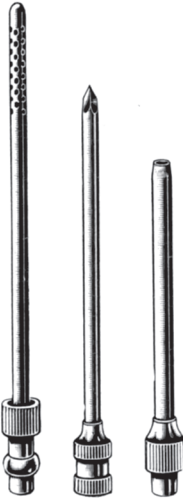

**DUKE**  
11.0cm  
G06.0104.55 5.5mm Ø



**BIRCH**  
18.0cm  
G06.0108.45 4.5mm Ø

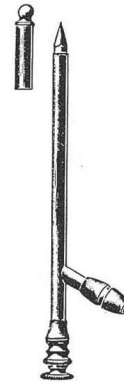

**OCHSNER**  
G06.0110.10 10 FG Ø  
G06.0110.12 12 FG Ø  
G06.0110.14 14 FG Ø  
G06.0110.16 16 FG Ø  
G06.0110.18 18 FG Ø  
G06.0110.20 20 FG Ø  
G06.0110.22 22 FG Ø



**OCHSNER**  
G06.0112.10 10 FG Ø  
G06.0112.12 12 FG Ø  
G06.0112.14 14 FG Ø  
G06.0112.16 16 FG Ø  
G06.0112.18 18 FG Ø  
G06.0112.20 20 FG Ø  
G06.0112.22 22 FG Ø

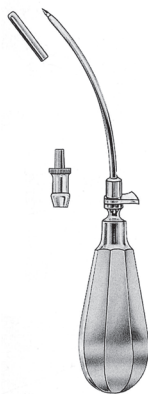

**PIERCE**  
G06.0128.30 3.0mm Ø  
G06.0128.40 4.0mm Ø  
G06.0128.50 5.0mm Ø



**LANDAU**  
G06.0134.20 2.0mm Ø

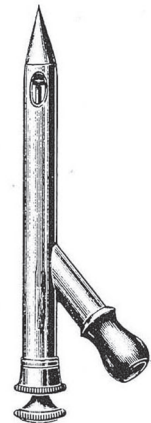

**PEAN**  
G06.0140.13 13.5mm Ø

G06-004 G06.0140.13



DE Trokare  
EN Trocars  
ES Trócares  
AR مبرزة

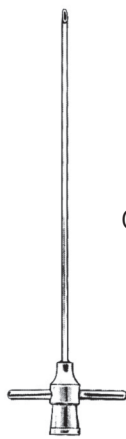

**RUSKIN**

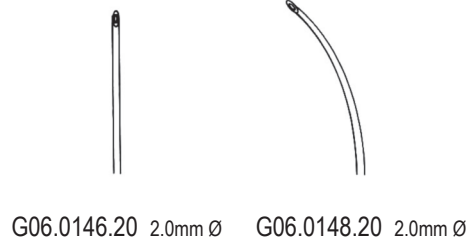

G06.0146.20 2.0mm Ø G06.0148.20 2.0mm Ø

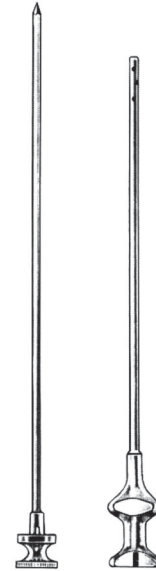

**EICKEN**

10.5cm

- G06.0156.18 1.8mm Ø
- G06.0156.20 2.0mm Ø
- G06.0156.30 3.0mm Ø

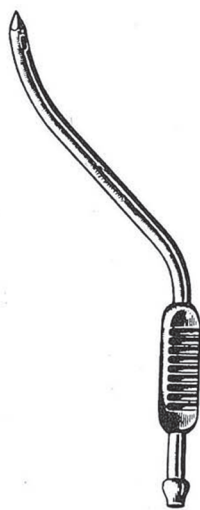

**DOUGLAS**

G06.0162.30 3.0mm Ø

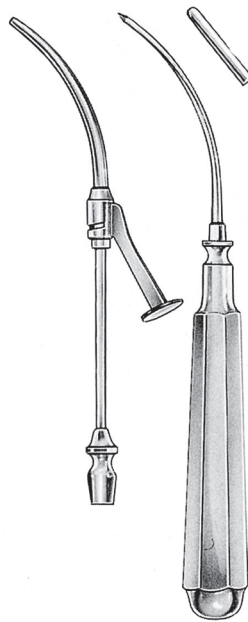

**COAKLEY**

G06.0166.22 2.25mm Ø

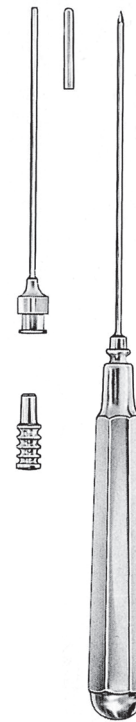

**LICHTWITZ**

- G06.0170.12 1.25mm Ø
- G06.0170.15 1.50mm Ø
- G06.0170.18 1.80mm Ø

G06.0170.18 **G06-005**



# G06

Führungsnadeln DE

Guide Needles EN

Agujas de guia ES

إبر دليل AR



**SCHMID**

G06.0176.30 3.0mm Ø

G06.0176.40 4.0mm Ø

G06.0176.50 5.0mm Ø

G06.0176.60 6.0mm Ø



**IOWA**

G06.0182.14 14.0cm



8 FG G06.0190.08  
10 FG G06.0190.10  
12 FG G06.0190.12  
14 FG G06.0190.14  
16 FG G06.0190.16  
18 FG G06.0190.18



G06.0192.08  
G06.0192.10  
G06.0192.12  
G06.0192.14  
G06.0192.16  
G06.0192.18



G06.0194.08  
G06.0194.10  
G06.0194.12  
G06.0194.14  
G06.0194.16  
G06.0194.18



**VERRES**

G06.0202.55 1.5 x 55mm Ø  
G06.0202.10 2.0 x 100mm Ø  
G06.0202.12 2.0 x 120mm Ø  
G06.0202.15 2.0 x 150mm Ø

**G06-006** G06.0202.15

DE	Saugrohre
EN	Suction Tubes
ES	Tubos de aspiración
AR	شفط أنابيب



**FERGUSON**

	11.0cm	13.0cm	16.0cm	18.0cm	20.0cm
1.5mm Ø	G06.0210.15	G06.0212.15	G06.0214.15	G06.0216.15	G06.0218.15
2.0mm Ø	G06.0210.20	G06.0212.20	G06.0214.20	G06.0216.20	G06.0218.20
2.5mm Ø	G06.0210.25	G06.0212.25	G06.0214.25	G06.0216.25	G06.0218.25
3.0mm Ø	G06.0210.30	G06.0212.30	G06.0214.30	G06.0216.30	G06.0218.30
4.0mm Ø	G06.0210.40	G06.0212.40	G06.0214.40	G06.0216.40	G06.0218.40
5.0mm Ø	G06.0210.50	G06.0212.50	G06.0214.50	G06.0216.50	G06.0218.50



**FERGUSON**

G06.0222.05	05 FG
G06.0222.06	06 FG
G06.0222.07	07 FG
G06.0222.08	08 FG
G06.0222.09	09 FG
G06.0222.10	10 FG
G06.0222.12	12 FG



**POPPE**

	13.0cm
G06.0228.06	06 FG
G06.0228.08	08 FG
G06.0228.10	10 FG
G06.0228.12	12 FG



**POPPE**

	13.0cm
G06.0234.08	08 FG
G06.0234.10	10 FG



**FRAZIER**

Charr.	19.0cm	
FG	30°	75°
06	G06.0240.06	G06.0242.06
07	G06.0240.07	G06.0242.07
08	G06.0240.08	G06.0242.08
09	G06.0240.09	G06.0242.09
10	G06.0240.10	G06.0242.10
11	G06.0240.11	G06.0242.11
12	G06.0240.12	G06.0242.12



**FRAZIER**

	19.0cm
G06.0246.08	08 FG
G06.0246.10	10 FG

G06.0246.10 **G06-007**





# G06

Saugrohre	DE
Suction Tubes	EN
Tubos de aspiración	ES
شفط أنابيب	AR



**PLESTER**

17.0cm

- G06.0252.15 1.5mm Ø
- G06.0252.20 2.0mm Ø
- G06.0252.25 2.5mm Ø
- G06.0252.30 3.0mm Ø



**ADSON**

16.5cm

G06.0258.80 3mm Ø

Olive  
8mm Ø



**ADSON**

21.0cm

G06.0266.40 4mm Ø



**LEMPERT**

20.0cm

- G06.0272.20 2.0mm Ø
- G06.0272.30 3.0mm Ø

Olive  
7 - 9mm Ø



**BARRON**

16.0cm

- G06.0278.13 1.3mm Ø
- G06.0278.20 2.0mm Ø

Olive  
8mm Ø



**SCHUHKNECHT**

13.0cm

- G06.0284.05 0.5mm Ø
- G06.0284.10 1.0mm Ø
- G06.0284.20 2.0mm Ø
- G06.0284.30 3.0mm Ø



**WULLSTEIN (set)**

G06.0290.00 14.0cm

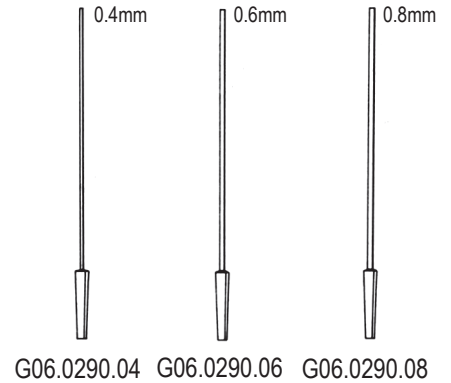

G06.0290.04 G06.0290.06 G06.0290.08

**G06-008** G06.0290.00

DE	Saugrohre
EN	Suction Tubes
ES	Tubos de aspiración
AR	شفط أنابيب

**ZOELLNER** (each 10 Pieces)

- G06.0302.04 0.4mm Ø
- G06.0302.05 0.5mm Ø
- G06.0302.07 0.7mm Ø
- G06.0302.10 1.0mm Ø
- G06.0302.12 1.2mm Ø



**ZOELLNER**

18.0cm

G06.0300.00 (Set)

G06.0300.01 (Cannula only 2.5mm Ø)

(Complete consists of suction cannula and detachable ends 06.0302.04 to 06.0302.12)

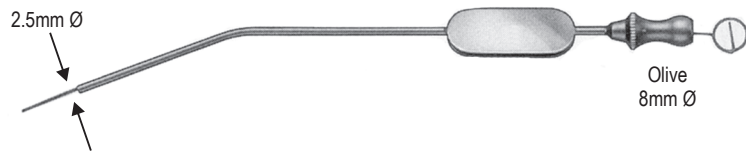

**BELLUCCI**

15.0cm

G06.0310.00 (Set)

G06.0310.01 (Cannula only)

(Complete consists of suction cannula and detachable ends 06.0302.05, 06.0302.07 & 06.0302.10)

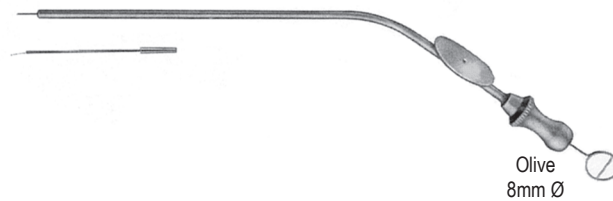

G06.0316.20 2.0mm Ø

G06.0316.25 2.5mm Ø

G06.0316.30 3.0mm Ø

(90° to curve with LUER hub)

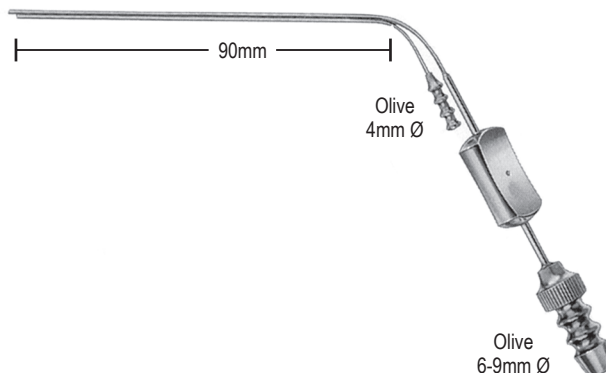
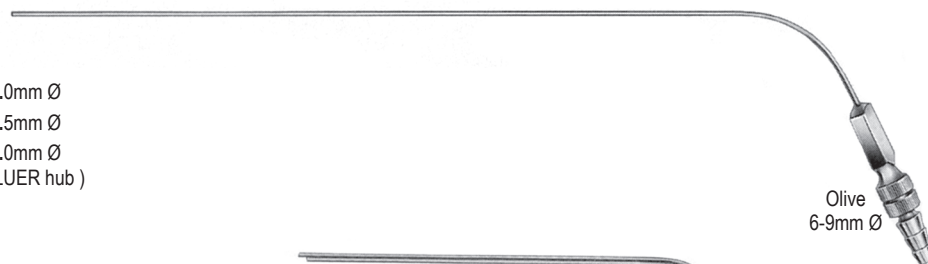

**HOUSE**

G06.0322.09 0.9mm Ø, 0.7mm Ø

G06.0322.12 1.2mm Ø, 0.9mm Ø

G06.0322.15 1.5mm Ø, 1.2mm Ø



### YASARGIL

Length	1.5mm Ø	2.0mm Ø	2.5mm Ø	3.5mm Ø
13.0cm	G06.0380.13	G06.0384.13	G06.0388.13	G06.0392.13
15.0cm	G06.0380.15	G06.0384.15	G06.0388.15	G06.0392.15
18.0cm	G06.0380.18	G06.0384.18	G06.0388.18	G06.0392.18
22.0cm	G06.0380.22	G06.0384.22	G06.0388.22	G06.0392.22

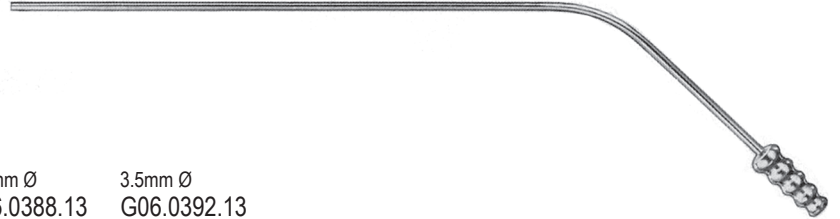

G06.0402.35 35.0cm  
G06.0402.50 50.0cm  
(With Rubber Tip)

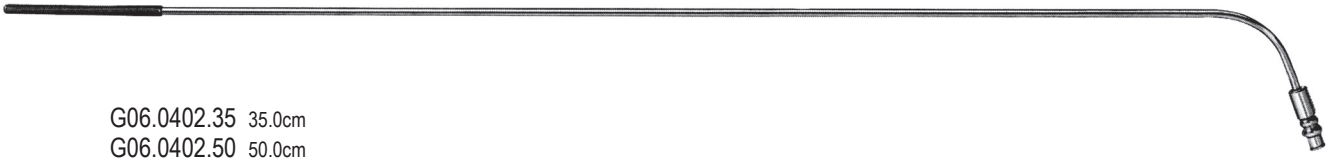

### MAGILL

G06.0408.30	3.0mm Ø
G06.0408.35	3.5mm Ø
G06.0408.40	4.0mm Ø
G06.0408.45	4.5mm Ø



G06.0408.01 Stilette for MAGILL suction tubes



DE	Saugrohre
EN	Suction Tubes
ES	Tubos de aspiración
AR	شفط أنابيب

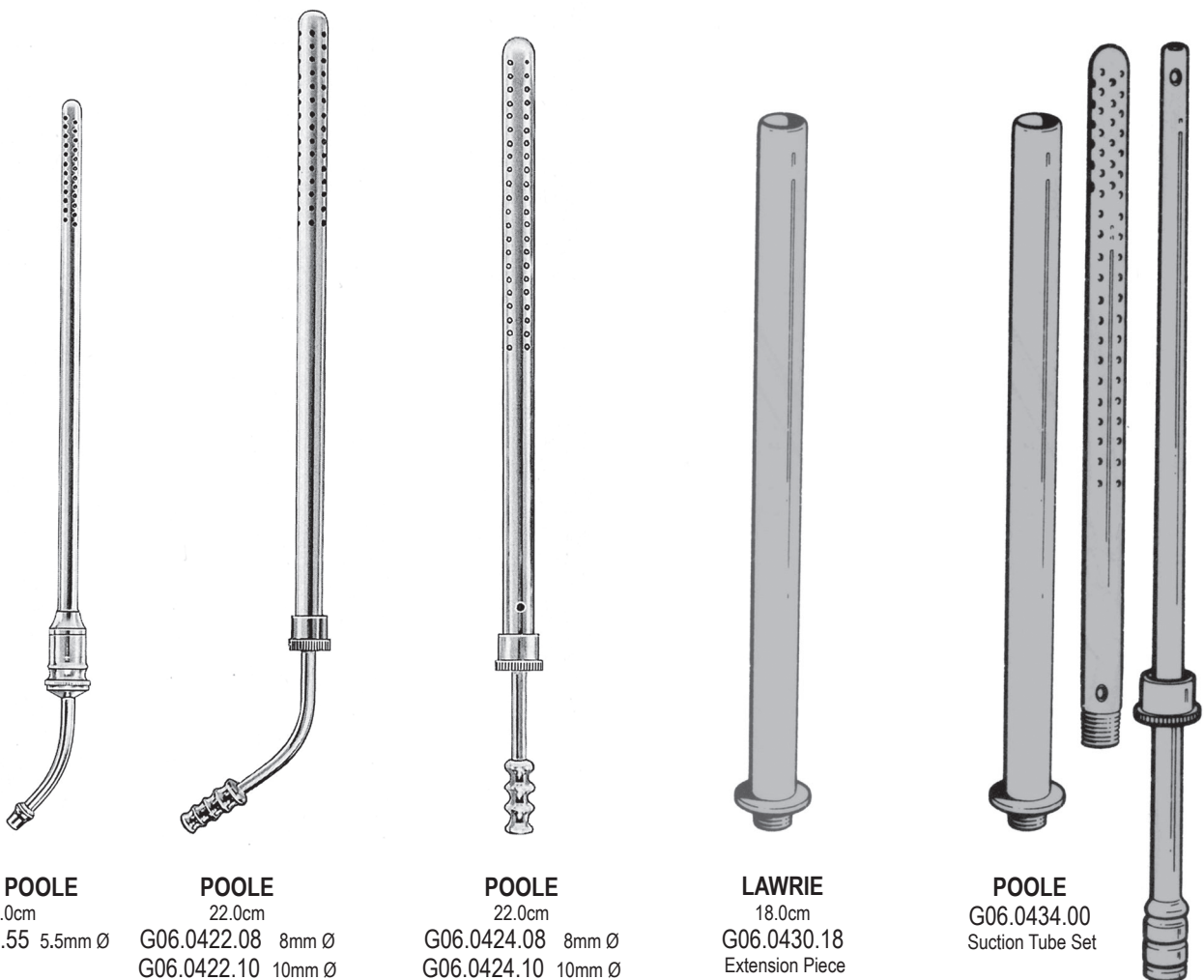

**BABY POOLE**  
20.0cm  
G06.0420.55 5.5mm Ø

**POOLE**  
22.0cm  
G06.0422.08 8mm Ø  
G06.0422.10 10mm Ø

**POOLE**  
22.0cm  
G06.0424.08 8mm Ø  
G06.0424.10 10mm Ø

**LAWRIE**  
18.0cm  
G06.0430.18  
Extension Piece

**POOLE**  
G06.0434.00  
Suction Tube Set





# G06

Saugrohre DE

Suction Tubes EN

Tubos de aspiración ES

شفط أنابيب AR



**COOLEY**  
30.0cm  
G06.0440.30 7mm Ø



**COOLEY**  
31.0cm  
G06.0442.31 10mm Ø

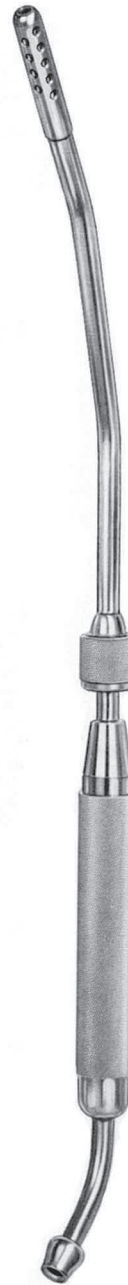

**COOLEY**  
33.0cm  
G06.0444.33 8mm Ø



**COOLEY**  
35.0cm  
06.0446.35 8mm Ø

G06-012 G06.0446.35

DE	Saugrohre
EN	Suction Tubes
ES	Tubos de aspiración
AR	شفط أنابيب

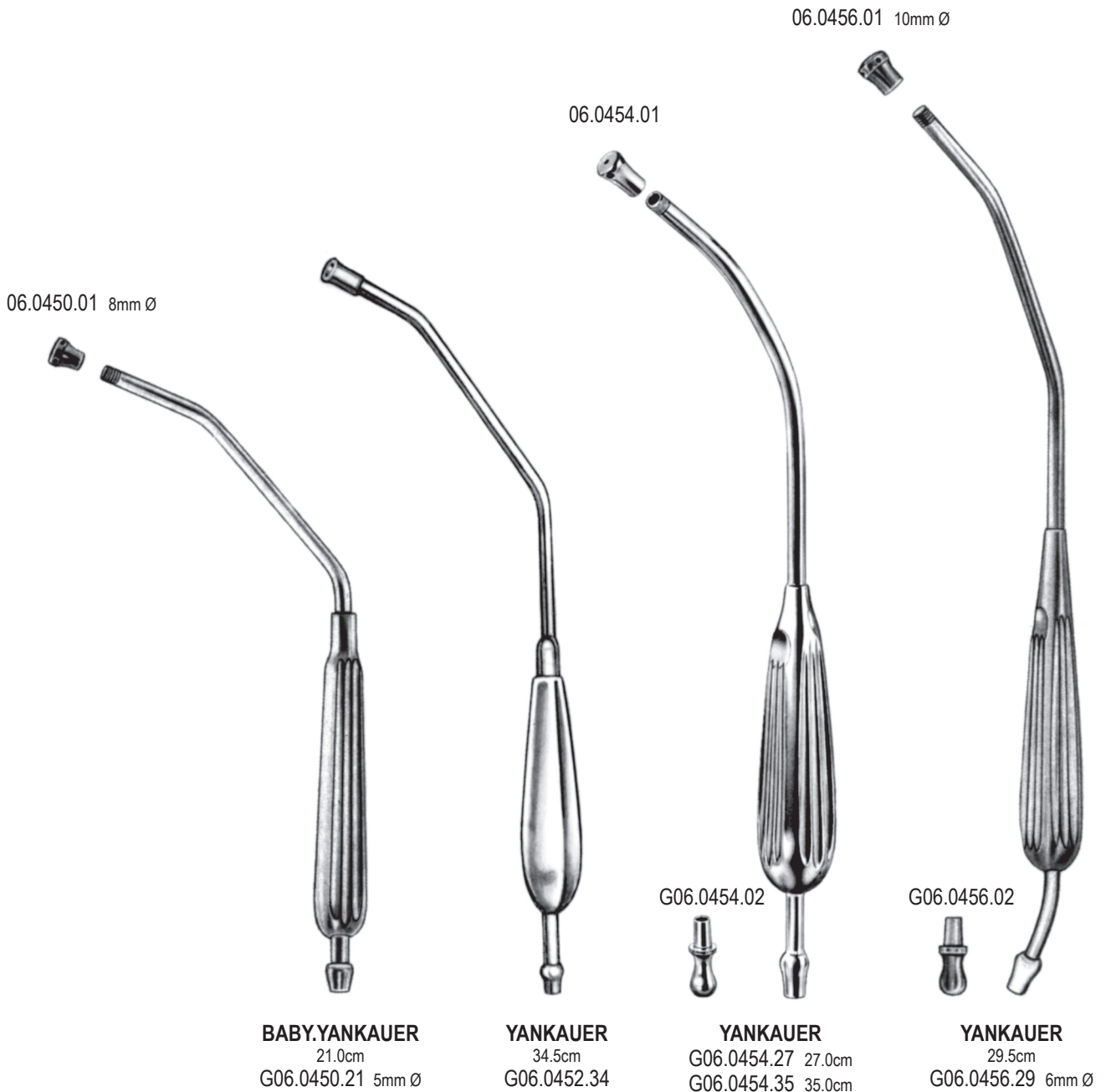

# G06

Saugrohre	DE
Suction Tubes	EN
Tubos de aspiración	ES
شفط أنابيب	AR



G06.0460.03

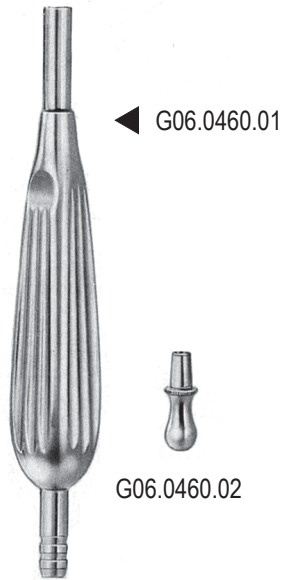
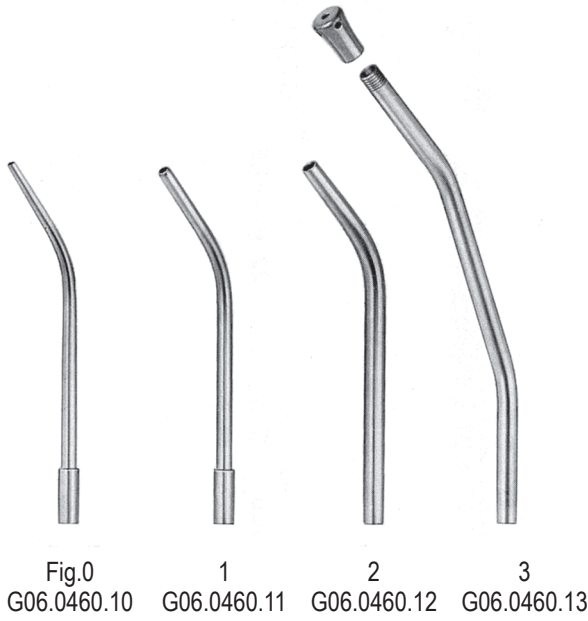

**YANKAUER**  
27.0cm  
G06.0460.27 set

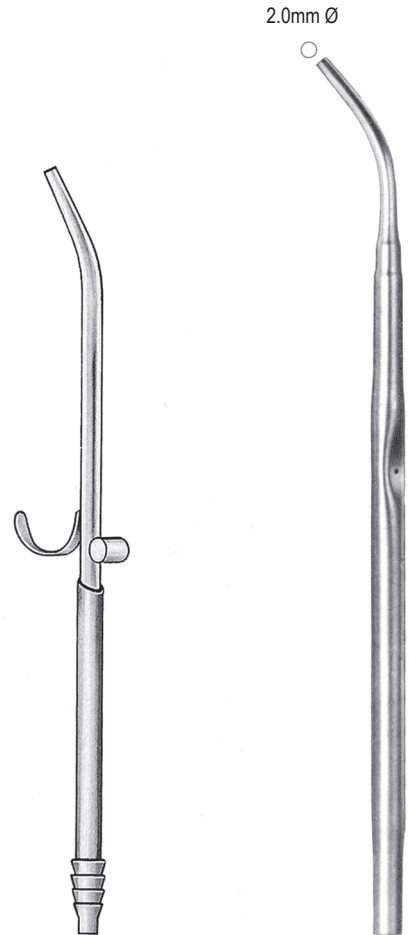

**BYRD**  
G06.0470.15 1.5mm Ø  
G06.0470.25 2.5mm Ø  
G06.0470.35 3.5mm Ø

**COGSWELL**  
23.0cm  
G06.0474.23 2.0mm Ø

**G06-014** G06.0474.23

DE	Saugrohre
EN	Suction Tubes
ES	Tubos de aspiración
AR	شفط أنابيب

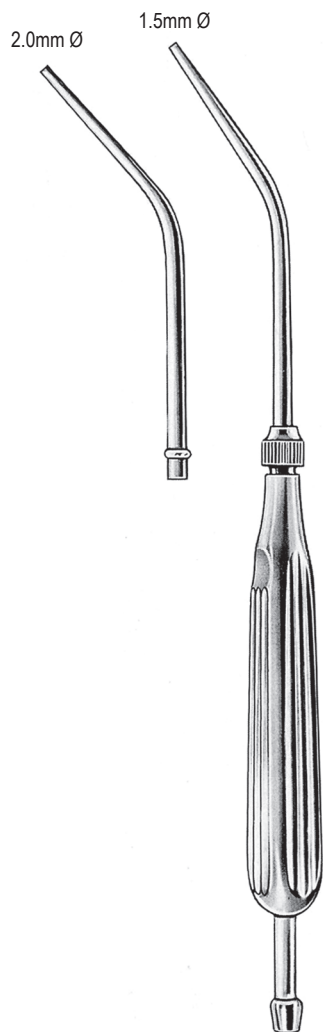

**COUPLAND**  
G06.0480.00 set

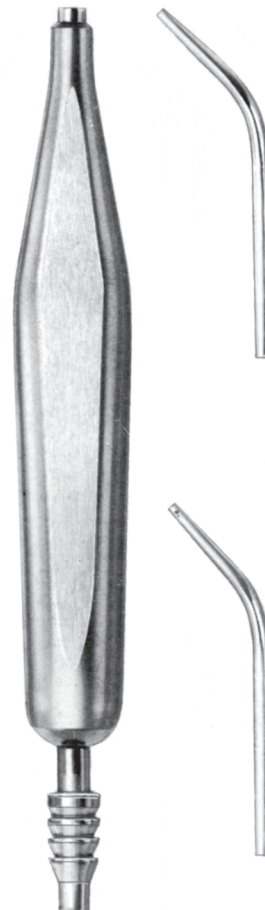

**COUPLAND**  
17.0cm  
G06.0484.17 set

- G06.0484.01 1.5mm Ø
- G06.0484.02 2.0mm Ø
- G06.0484.03 2.5mm Ø
- G06.0484.04 3.5mm Ø
- G06.0484.05 1.5mm Ø
- G06.0484.06 2.0mm Ø
- G06.0484.07 2.5mm Ø
- G06.0484.08 3.5mm Ø





# G06

Saugrohre DE

Suction Tubes EN

Tubos de aspiración ES

شفط أنابيب AR

8mm Ø

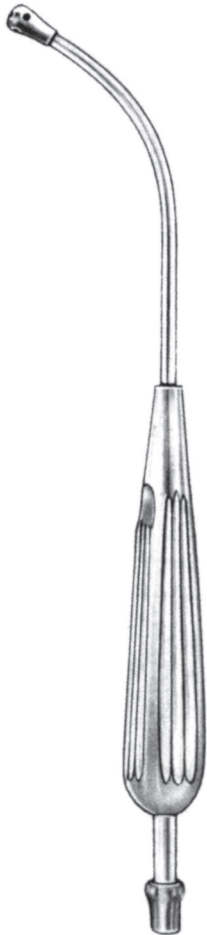

**ANDREW-PYNCHON**  
G06.0490.24 24.0cm

9mm Ø

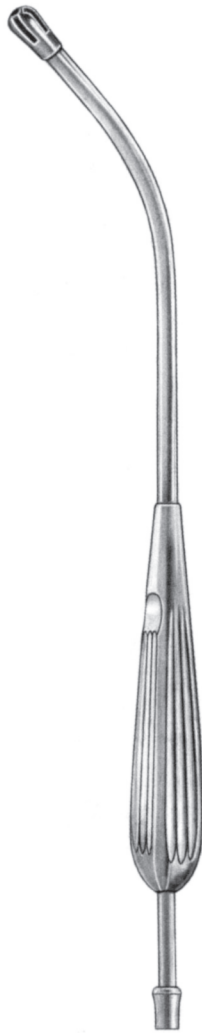

**DEBAKEY**  
G06.0494.28 28.0cm

5mm Ø

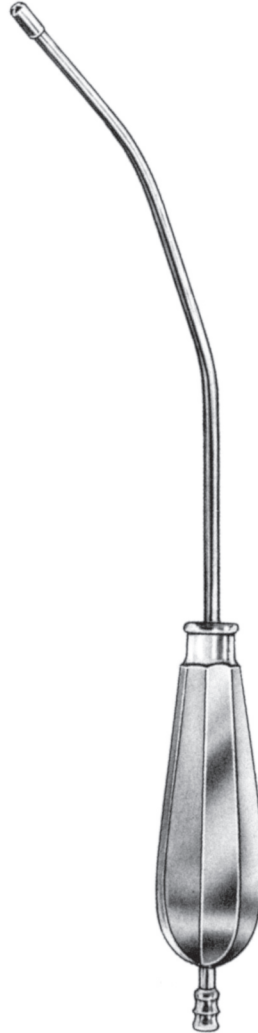

**BROMPTON**  
G06.0500.29 29.0cm

4mm Ø

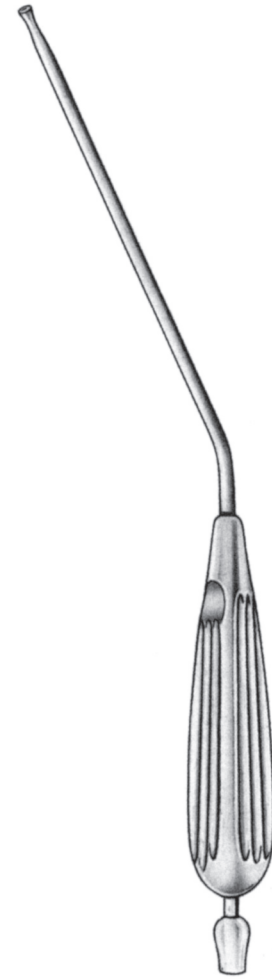

**ANTHONY**  
G06.0504.27 27.0cm

G06-016 G06.0504.27

DE	Saugrohre
EN	Suction Tubes
ES	Tubos de aspiración
AR	شفط أنابيب

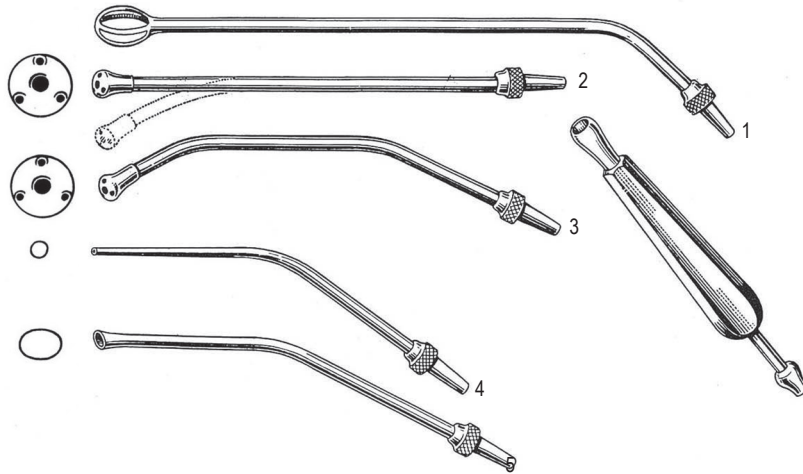

**UNIVERSAL**  
G06.0510.00 (Set)

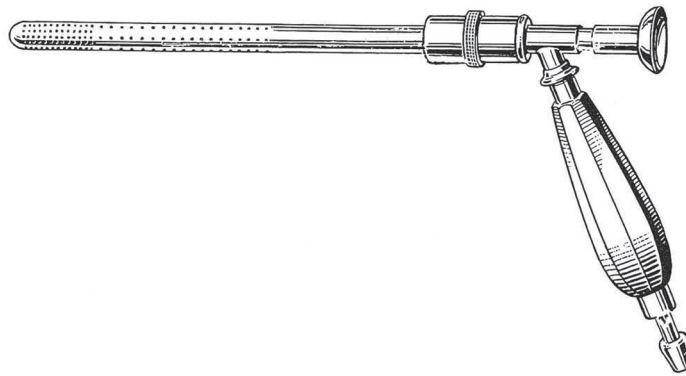

**SIMPSON-SMITH**  
G06.0514.00 (Complete)

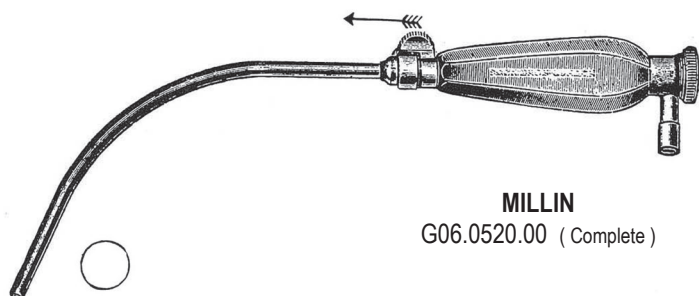

**MILLIN**  
G06.0520.00 (Complete)





[www.gsi-medical.de](http://www.gsi-medical.de)